

# MONOi/MONOe-A

INDOOR/OUTDOOR SINGLE CORE  
HEAT SHRINKABLE TERMINATION

INSTALLATION INSTRUCTION IM1982IA.2 - ed. 15/09/2020

TYPE OF CABLE: Solid insulation (XLPE-HEPR)

SECTION: Up to 1600 mm<sup>2</sup> Cu/Al

TYPE OF SCREEN: Copper tape screen

VOLTAGE: U<sub>max</sub> 24 kV



# 1 ASSEMBLY OF THE TERMINATION

## 1.1

Prepare the cable and cut the exceeding length.

## 1.2

Remove the outer sheath for the length “L” (“L” see the table).  
Abrade the outer sheath for 100 mm and clean with solvent.

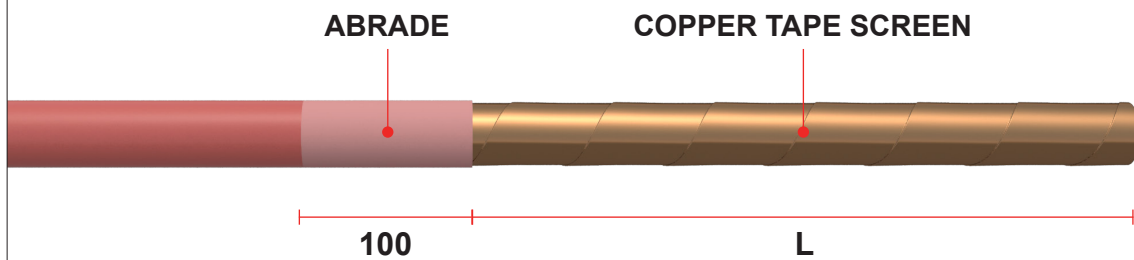

TYPE	INDOOR TYPE							
SECTION RANGE (mm <sup>2</sup> )	25 ÷ 95	70 ÷ 240	95 ÷ 300	185 ÷ 400	400 ÷ 630	630 ÷ 1000	800 ÷ 1200	1200 ÷ 1600
<b>L</b> (mm)	300	300	300	350	350	350	400	400

TYPE	OUTDOOR TYPE							
SECTION RANGE (mm <sup>2</sup> )	25 ÷ 95	70 ÷ 240	95 ÷ 300	185 ÷ 400	400 ÷ 630	630 ÷ 1000	800 ÷ 1200	1200 ÷ 1600
<b>L</b> (mm)	450	450	450	450	550	550	550	550

## 1.3

Remove the copper tape screen leaving 25 mm out of the outer sheath.

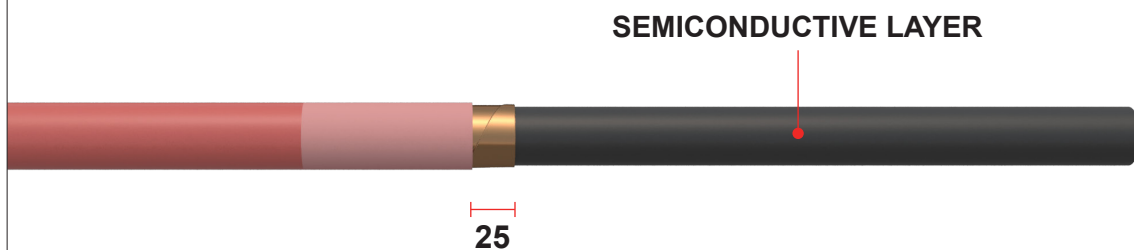

● 1.4

Remove the semi-conductive layer leaving 15 mm out of the copper tape screen taking care not to damage the insulation.

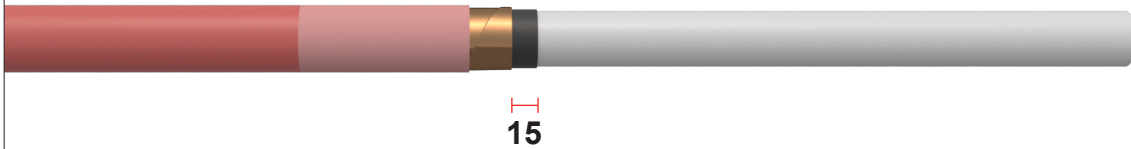

● 1.5

Bare the conductor for the length "C" ("C"= inside depth of lug) for bolted lug or "C+5mm" in case of compression lug.

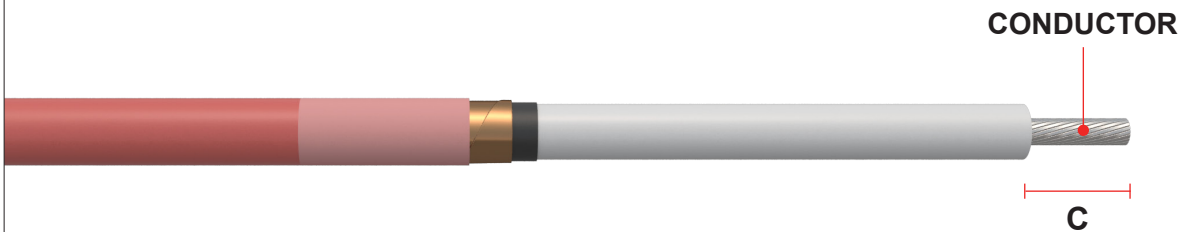

● 1.6

Position the lug and crimp it or break the screws in case of bolted lug following the manufacturer's instructions.



● 1.7

Apply a layer of red mastic "MBA" (20% overlap) on the outer sheath for 30 mm.

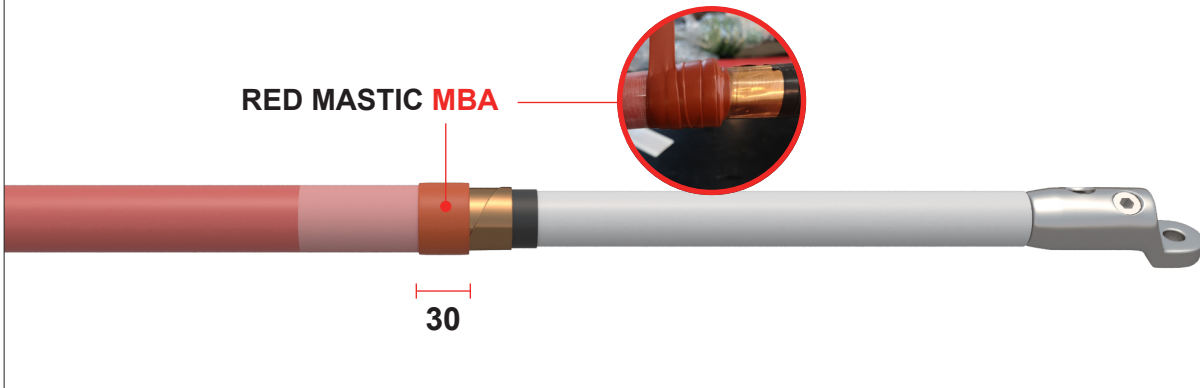

● 1.8

Position the earthing braid over the copper tape screen.

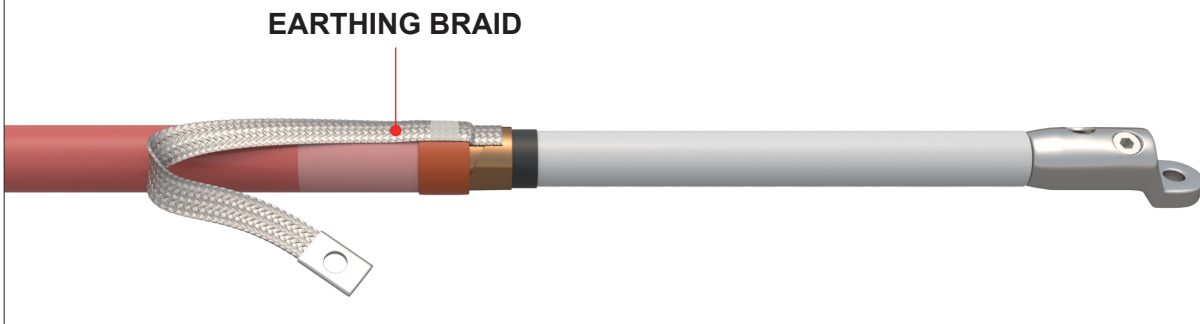

● 1.9

Connect the braid to the copper tape screen with the roll force spring.

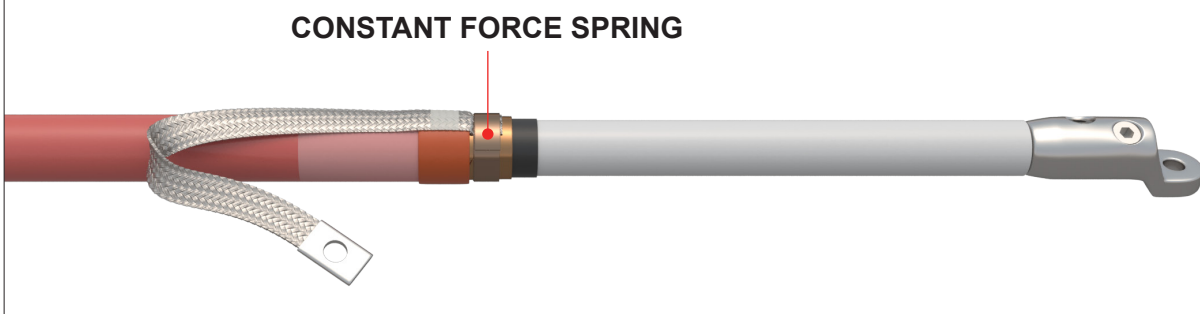

● 1.10

Fill the cavities of the lug with red mastic "MBA".

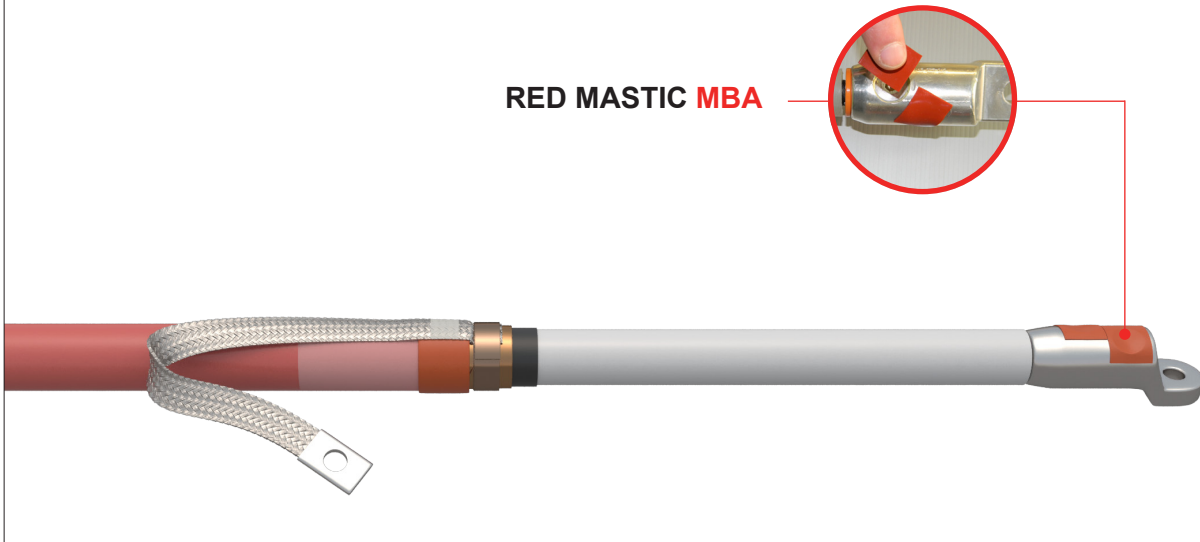

● 1.11

Wrap around the exposed conductor the red mastic "MBA" stretching it, wrap till reaching the lug barrel diameter. Wrap also the same mastic around the lug barrel. Apply a layer of red mastic "MBA" starting from cut outer sheath till covering the previous applied layer of "MBA" mastic.

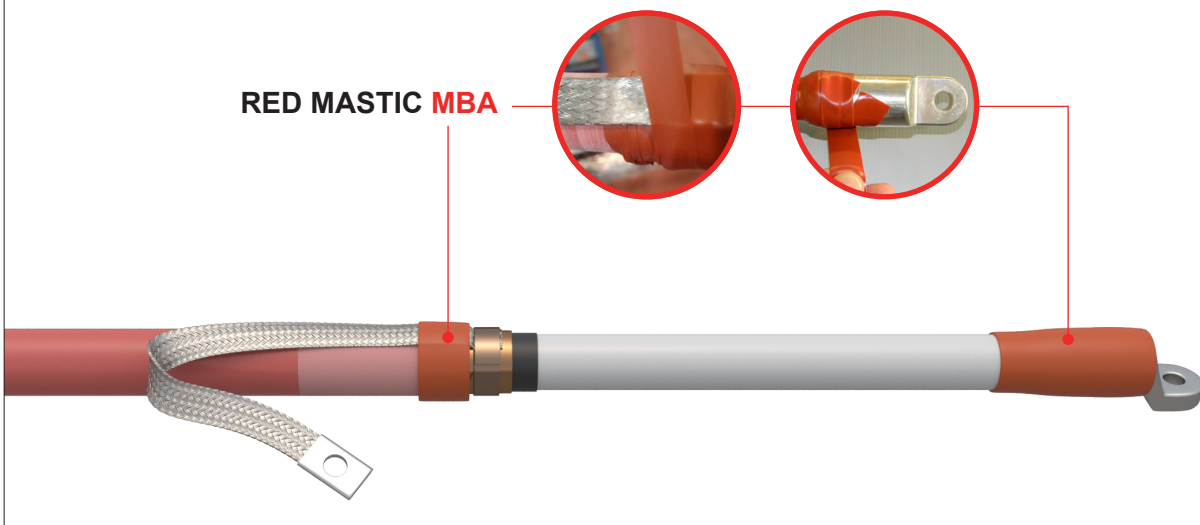

● 1.12

Remove the protective paper (the one with the printing) from the MACD pad.  
Apply the stress relief mastic pad "MACD", lightly stretched, starting from the cut outer sheath.



● 1.13

Slide the red tube "GT12" (stress control + insulation) till the TOP edge of red mastic "MBA" applied over the cable lug.

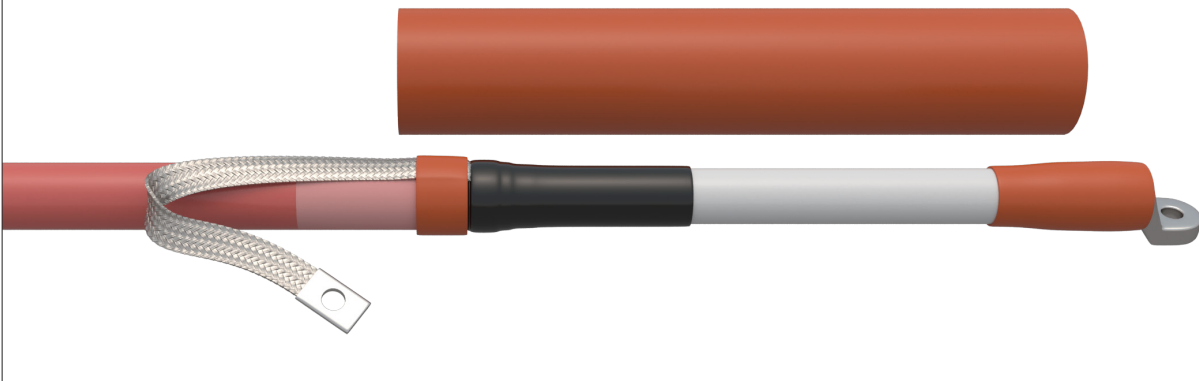

● 1.14

Start heatshrinking from the top downwards.

**INDOOR TERMINATION IS FINISHED**

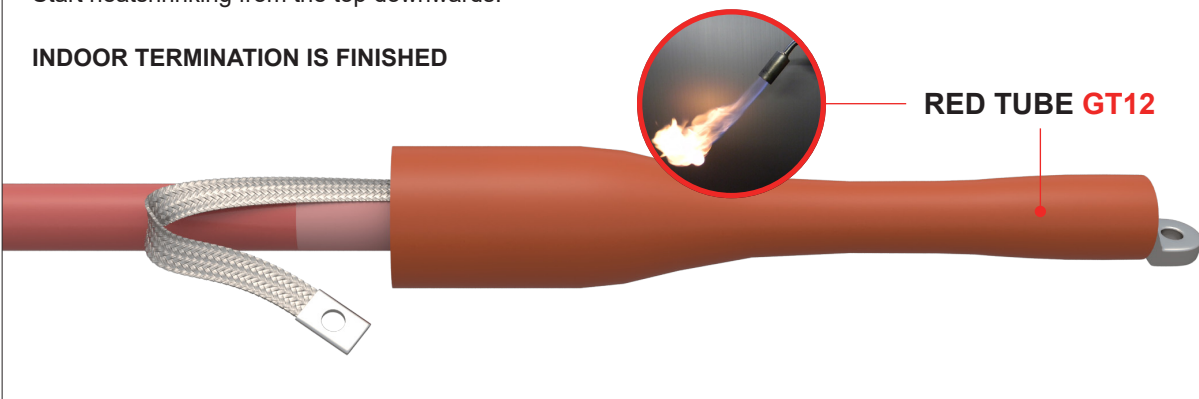

● **1.15 ONLY FOR OUTDOOR TERMINATION**

Slide the first antitracking shed at 160 mm from the bottom edge of shrunk tube and heatshrink.  
Slide the remaining shed and heatshrink.  
Different number of sheds tall lengths available upon request.

**OUTDOOR TERMINATION IS FINISHED**

**INDOOR  
TERMINATION**



**OUTDOOR  
TERMINATION**

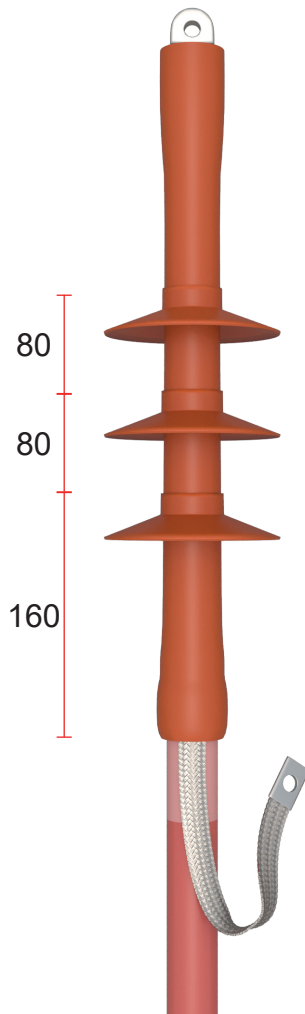

**REVERSED  
OUTDOOR  
TERMINATION**

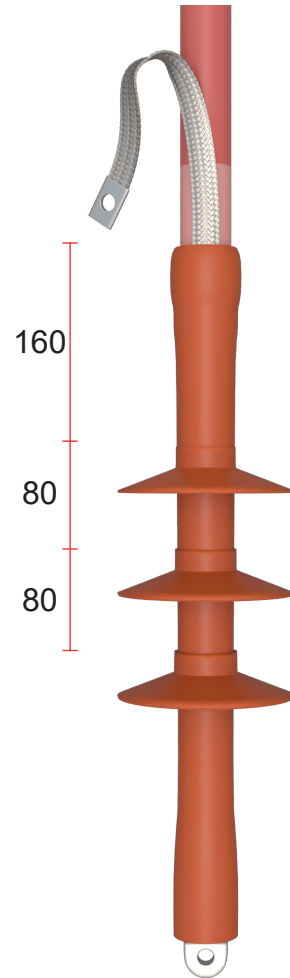

Adjust torch to give a soft blue flame with yellow tip.  
Heatshrink tubes uniformly avoiding wrinkles along the surface.  
Keep the flame moving continuously and maintain adequate distance to avoid over heating.

This product should be installed by competent personnel familiar with electrical equipment and safe operating practices. Parts contained in this kit should be visually inspected for possible damage, and installed in accordance with these instructions. These instructions are not intended as a substitute for adequate training and experience.



Please dispose of all waste according to environmental regulations.

The company reserves the right to alter without notice the information contained in this installation manual.

**Nexans Italia S.p.A.**

[nexans.com/power\\_accessories](https://nexans.com/power_accessories)  
[sales.npai@nexans.com](mailto:sales.npai@nexans.com)

