



 **INSTALLATION PRODUCTS**



**CABLE, CONDUCTOR,  
WIRE, HOSE AND  
FIBRE INSTALLATION  
AND SUPPORT**

**MADE EASIER,  
SAFER AND MORE  
DEPENDABLE**

FROM INNOVATIVE DESIGN,  
PROTOTYPING AND PRODUCT  
CUSTOMISATION, THROUGH  
MANUFACTURE, SUPPLY  
AND AFTER-SALES SERVICE

**SLINGCO DELIVERS**



**PULLING**

<b>HEAVY DUTY GRIPS</b>	
A Type - High Strength Cable Grip	6
Splicing Grip - Non-Rotating Multi Weave	6
MU Type - Multi Weave Cable Grip	7
R Type - Rotating Multi-Weave Cable Grip	7
ST Type - Single Eye Double Weave Cable Grip	8
RT Type - Rotating Eye Double Weave Cable Grip	8
<b>SPLICING GRIPS</b>	
Splicing Grip - Rotating Swivel Link	9
Splicing Grip - Rotating Barrel	9
Splicing Grip - Non-Rotating Multi Weave	9
<b>LIGHT-MEDIUM DUTY GRIPS</b>	
SE Type - Single Eye Cable Grip	10
OS Type - Offset Eye Cable Grip	10
DE Type - Double Eye Cable Grip	11
L Type - Lace Up Cable Grip	11
Open Ended Cable Grip	12
Fibre Optic Cable Grip	12
<b>CLOSE WEAVE GRIPS - FLEXIBLE &amp; THIMBLE EYE</b>	
Flexible & Thimble Eye Cable Grip - Single Eye	13
Flexible & Thimble Eye Cable Grip - Double Eye	13
<b>NON-METALLIC (ARAMID) GRIPS</b>	
NS - Non-Metallic (Aramid) Single Eye Cable Grip	14
ND - Non-Metallic (Aramid) Double Eye Cable Grip	14
NO - Non-Metallic (Aramid) Offset Eye Cable Grip	14
<b>HEAVY DUTY LARGE DIAMETER GRIPS / HOSE ARMOUR</b>	
Marine Cable Grip	15
Hose Armour Grips for Hose Protection	15
<b>HOSE RESTRAINT GRIPS / WHIPSOCKS</b>	
Heavy Duty Hose Restraint Grip / Whipsack	16
Speciality Hose Restraint Grip	16
<b>LINE PULLING SWIVELS</b>	
Line Pulling Swivel - Bright Zinc Plated Steel	17
Line Pulling Swivel - Galvanised	17

**CONTROL AND GUIDANCE**

<b>CONTROL AND GUIDANCE</b>	
Anti-Rotational Device (ARD)	18
Load Sensing Device (LSD)	19
Transmission Line Stringing	20
Pulley Bundle	21
Bull Wheel	21
Swivel Tester	21
Connectors: 90°, Rope to Rope, Rope to Swivel	22
Cable Laying Roller	22
Feed Tube	22

**CABLE SUPPORT**

<b>CABLE SUPPORT GRIPS</b>	
Wind Turbine Cable Grip - Heavy Duty Thimble Offset Eye	23
Extended Thimble Eye Heavy Duty Stainless Steel Cable Grip	23
Single Eye Closed Mesh Cable Support Grip	24
Single Eye Split Mesh Lace Closing Support Grip	24
Single Eye Split Mesh Rod Closing Cable Support Grip	24
Double Eye Closed Mesh Cable Support Grip	25
Double Eye Split Mesh Lace Closing Support Grip	25
Double Eye Split Mesh Rod Closing Cable Support Grip	25
Offset Eye Closed Mesh Cable Support Grip	26
Offset Eye Split Mesh Lace Closing Support Grip	26
Offset Eye Split Mesh Rod Closing Cable Support Grip	26
Universal Eye Closed Mesh Cable Support Grip	27
Universal Eye Split Mesh Lace Closing Support Grip	27
Universal Eye Split Mesh Rod Closing Cable Support Grip	27
Conduit Riser Cable Grip - Stainless Steel	28
Hooked Eye Conduit Support Cable Grip	28
Stainless Steel Connector/Box Grip	29

**CABLE PROTECTION & CEMENTING**

<b>CABLE PROTECTORS</b>	
Standard Cable Protector	30
Centralising Cable Protector	30
Mid-Joint Cable Protector	31
Banded Cable Protector	31
<b>CENTRALISERS</b>	
Bow Spring Centralisers	32
Rigid Centralisers	32

**TECHNICAL INFORMATION**

Important Technical and Safety Information	33
Single and Double Eye Cable Grip Instructions	34
Lace Up Cable Grip Instructions	35

**A GLOBAL BUSINESS BUILT ON  
QUALITY, INNOVATION, SERVICE  
...AND REAL FAMILY TIES**

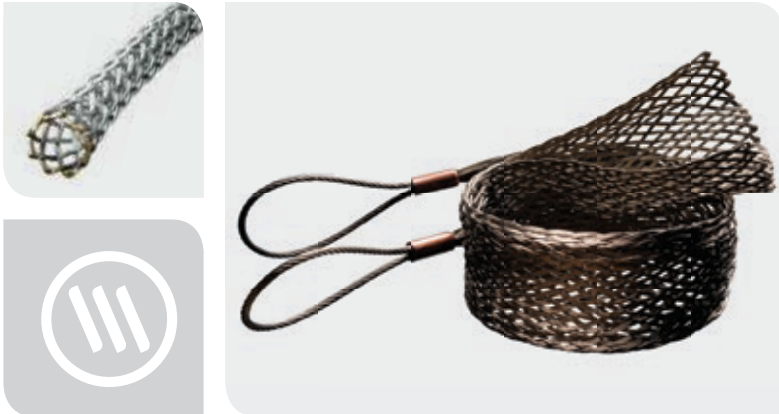

**W**elcome to Slingco, a world-leading supplier of cable grips and wire rope. Founded by our father, Chris Dykins, more than 40 years ago, Slingco remains a family-owned business but has evolved into an expert design and manufacturing operation, producing high quality cable grips, wire rope assemblies and more - products that are renowned for high performance in quality-critical applications.

Slingco operates out of regional bases in the UK and USA, but you'll find our products around the world, making heavy-duty cable and conductor installation and support a whole lot easier for people working in industries as varied as oil and gas, marine and offshore, public utilities, civil engineering, aerospace, transport, the military, performing arts, vehicle building, construction and more.

You can't make mistakes when you're dealing with products like ours. Too much depends on them. That's why we're obsessive about quality and innovation in design and manufacturing, and why nothing leaves our hands that isn't 100% dependable.

Because we understand exactly what your operation needs, we also know cost is a factor. We keep our prices realistic and hold a vast range of stock for fast - even same day - delivery.

We're brothers, partners and the driving force behind Slingco, but we're only a small part of the whole picture. We've got a fantastic team of skilled people who share our obsession with quality and great service. We're proud of every one of them.

Together, we're going to carry on developing outstanding products. We're going to carry on getting them out to you in record time. And we're going to carry on being the sort of company it's a pleasure to deal with.

NICK DYKINS  
CEO, SLINGCO LIMITED

MATT DYKINS  
PRESIDENT, SLINGCO AMERICA





## **INSTALLATION PRODUCTS**



### **QUALITY, SAFETY AND TESTING**

Cables, conductors, hoses and their associated supports are by definition, safety-critical components and we recognize that this places us in a real position of responsibility. Hence all our products are designed, manufactured and tested to exacting standards to ensure safe and dependable operation under even the most challenging conditions. We operate a quality management system and are accredited to ISO 9001.

**Our aim is to be your preferred supply partner, not just to sell you a product**

### **IN-HOUSE DESIGN**

An integral part of our manufacturing facility is our dedicated in-house design engineering team. As well as being focused on our own design and development projects, our engineering team's skills - employing cutting-edge 3D modeling and finite element analysis software - are available to our customers.

From initial product design and manufacture to technical support and customer service, the strength of our business lies in the skills and commitment of our people. They're here to serve you and we're confident that this shows in everything we do.

**ALL SLINGCO PRODUCTS ARE DESIGNED, MANUFACTURED AND TESTED TO EXACTING STANDARDS**

**ENSURING SAFE AND DEPENDABLE OPERATION UNDER EVEN THE MOST CHALLENGING CONDITIONS**

If you've a specific requirement you think we could help with, or would just like to make contact for a general discussion, please call us on **+44 [0]1706 855558** or email **sales@slingco.com**.

## PULLING PRODUCTS

Choose from a comprehensive range of cable and conductor pulling products, each designed and engineered to deliver reliable performance for the installation of cables or pipes through ducts, conduits and trenches. The cable grip adds little to the overall diameter of the cable and 'free passage' is normally available through sheave blocks and pipes.

- Light-medium and heavy duty options
- Precise, hand-woven construction
- Ideal on 'new for old' cable installations
- Swivel links for reduced torque build-up
- Growing range of pulling accessories

### A TYPE - HIGH STRENGTH CABLE GRIP



This is the strongest grip we produce. It can be used for conductor and synthetic rope pulls. A Type grips are colour coded for ease of identification. Perfect for overhead transmission and distribution line pulling projects or any other pulling applications with heavy load ratings such as electric railroad, rigging lines and construction pulls. When pulling synthetic rope use a Slingco Feed Tube (see page 22) to make inserting rope into the grip a breeze. Made of galvanised steel. To avoid the effects of torsion a line pulling swivel that rotates under load should be used with pulling grips.

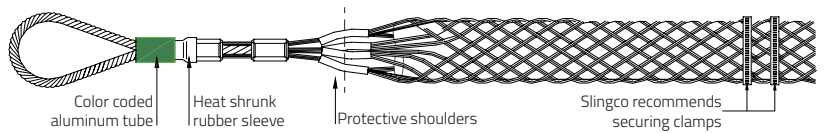

Slingco Part No	Colour Code	Rope Diameter Range		Conductor Diameter Range		Overall length		Lattice Length		Approx. Break Load	
		in	mm	in	mm	in	mm	in	mm	lb	kg
ZCS1799	Black	0.25 - 0.65	6-16	0.19 - 0.40	5-10	40	1,003	28	718	7,000	3,180
ZCS3020	Purple	0.30 - 0.40	7.5-10	0.25 - 0.40	6-10	41	1,030	30	760	10,000	4,530
ZCS1800	Dark Green	0.50 - 0.90	13-23	0.32 - 0.62	10-16	55	1,397	41	1,054	14,000	6,360
ZCS3522	Grey	0.44 - 0.90	11-16	0.44 - 0.63	11-16	123	3,125	109	2,770	20,000	9,075
ZCS1801	Red	0.75 - 1.10	19-28	0.63 - 0.87	16-22	74	1,880	58	1,473	20,000	9,090
ZCS1802	Blue	1.00 - 1.50	25-38	0.88 - 1.12	22-29	87	2,210	68	1,727	30,700	13,955
ZCS1803	Yellow	1.25 - 1.70	32-43	1.13 - 1.37	29-35	112	2,845	90	2,299	47,000	21,360
ZCS1804	Aluminium	1.50 - 2.10	38-53	1.38 - 1.90	35-50	121	3,073	96	2,438	67,000	30,455

### SPLICING GRIP - NON-ROTATING MULTI-WEAVE



Slingco Splicing Grips are made from multi weave construction for temporary splicing of conductor and wire ropes as well as cable reinforcements. Made of galvanised steel.

Slingco Part No	Colour Code	Range		Lattice Length		Approx. Break Load	
		in	mm	in	mm	lb	kg
ZCS2552	Dark Green	0.25 - 0.49	6-12	63	1,574	7,000	3,175
ZCS2553	Brown	0.50 - 0.74	12-19	90	2,286	10,500	4,760
ZCS2446	Light Blue	0.75 - 0.99	19-25	90	2,286	14,100	6,395
ZCS2554	Gold	1.00 - 1.24	25-31	130	3,302	25,000	11,340
ZCS2547	Black	1.25 - 1.49	31-38	130	3,302	31,000	14,065
ZCS2555	Red	1.50 - 1.74	38-44	164	4,166	31,000	14,065
ZCS2556	Dark Blue	1.75 - 2.24	44-57	164	4,166	49,000	18,000

**MU TYPE - HIGH STRENGTH GRIP**

This grip's triple weave construction is ideal for heavy loads. MU grips are colour coded for ease of identification. Perfect for stringing overhead transmission and distribution lines and heavy-load pulls of any kind. Use with bare or insulated cable, conductor or wire. The flexible eye connects with Slingco line pulling swivels for trouble free pulling applications. Made of galvanised steel.



Slingco Part No	Colour Code	Range		Lattice Length		Approx. Break Load	
		in	mm	in	mm	lb	kg
ZCS1710	Dark Green	0.25 - 0.50	6-12	31	787	7,000	3,170
ZCS1711	Brown	0.50 - 0.75	12-19	45	1,143	10,500	4,760
ZCS1712	Light Blue	0.75 - 1.00	19-25	43	1,092	14,100	6,395
ZCS1713	Gold	1.00 - 1.25	25-32	65	1,651	25,000	11,340
ZCS1714	Black	1.25 - 1.50	32-38	59	1,499	31,000	14,065
ZCS1715	Red	1.50 - 1.75	38-44	82	2,083	31,000	14,065
ZCS1716	Dark Blue	1.75 - 2.25	44-57	82	2,083	49,000	22,230
ZCS1750	Yellow	2.00 - 2.50	50-63	72	1,829	49,000	22,230
ZCS1751	Orange	2.50 - 3.00	63-76	72	1,829	49,000	22,230
ZCS1752	Aluminium	3.00 - 3.50	76-89	74	1,880	49,000	22,230
ZCS1753	Light Green	3.50 - 4.00	89-102	76	1,930	49,000	22,230

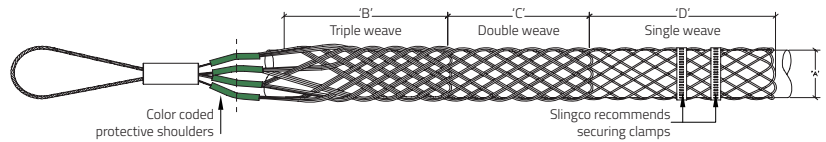

**R TYPE - ROTATING MULTI-WEAVE GRIP**

Like the MU type, the rotating eye grip has a triple weave construction and is colour coded for ease of identification. The steel forged revolving head is ideal for connecting to Slingco swivels. Warning: The Slingco rotating eye does not revolve under load and does not replace the use of a line swivel. Please see page 17 for swivel and grip match-up and safety and technical information. Made of galvanised steel.



Slingco Part No	Colour Code	Range		Lattice Length		Approx. Break Load	
		in	mm	in	mm	lb	kg
ZCS2177	Dark Green	0.25 - 0.50	6-12	31	787	7,000	3,170
ZCS2178	Brown	0.50 - 0.75	12-19	45	1,143	10,500	4,760
ZCS2179	Light Blue	0.75 - 1.00	19-25	43	1,092	14,100	6,395
ZCS2180	Gold	1.00 - 1.25	25-32	65	1,651	25,000	11,340
ZCS2181	Black	1.25 - 1.50	32-38	59	1,499	31,000	14,065
ZCS2182	Red	1.50 - 1.75	38-44	82	2,083	31,000	14,065
ZCS2183	Dark blue	1.75 - 2.25	44-57	82	2,083	43,000	19,510
ZCS2779	Yellow	2.00 - 2.50	50-63	72	1,829	43,000	19,510
ZCS2780	Orange	2.50 - 3.00	63-76	72	1,829	43,000	19,510
ZCS2781	Aluminium	3.00 - 3.50	76-89	74	1,880	43,000	19,510
ZCS2782	Light Green	3.50 - 4.00	89-102	76	1,930	43,000	19,510

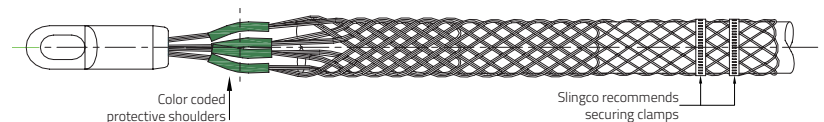

**CAN'T FIND THE SPECIFICATION YOU NEED?**

Call or email for full ranges plus custom manufacture options

**01706 855558**

sales@slingco.com

# HEAVY DUTY GRIPS

## ST TYPE - SINGLE EYE DOUBLE WEAVE GRIP



This Slingco grip features a double weave construction for medium to heavy pulling applications in underground installations.

Slingco Part No	Range		Lattice Length		Approx. Break Load	
	in	mm	in	mm	lb	kg
<b>SHORT LENGTH - GALVANISED STEEL</b>						
ZCS2511	0.50 - 0.62	13-16	21	534	4,500	2,040
ZCS2512	0.62 - 0.75	16-19	24	610	5,600	2,540
ZCS2513	0.75 - 1.00	19-25	24	610	6,800	3,085
ZCS2514	1.00 - 1.50	25-38	24	610	9,600	4,355
ZCS2515	1.50 - 2.00	38-50	24	610	16,400	7,441
ZCS2516	2.00 - 2.50	50-63	24	610	18,500	8,390
ZCS2517	2.50 - 3.00	63-76	24	610	24,500	11,115
ZCS2518	3.00 - 3.50	76-89	24	610	24,500	11,115
ZCS2519	3.50 - 4.00	89-102	26	660	31,000	14,065
<b>LONGER LENGTH - GALVANISED STEEL</b>						
ZCS2520	0.75 - 1.00	19-25	36	914	6,800	3,085
ZCS2521	1.00 - 1.50	25-38	36	914	9,600	4,355
ZCS2522	1.50 - 2.00	38-50	36	914	16,400	7,440
ZCS2523	2.00 - 2.50	50-63	36	914	18,500	8,390
ZCS2524	2.50 - 3.00	63-76	36	914	24,500	11,115
ZCS2777	3.00 - 3.50	76-89	36	914	24,500	11,115
ZCS2778	3.50 - 4.00	89-102	40	1,010	31,000	14,065

## RT TYPE - ROTATING EYE DOUBLE WEAVE GRIP



Double weave construction for medium to heavy pulling applications in underground installations. Additionally its steel forged revolving head is ideal for connecting to Slingco swivels. Warning: The Slingco RT Type Rotating Eye Grip does not revolve under load. The rotating eye does not replace the need for a swivel. Please see page 17 for swivel and grip match-up and safety and technical information.

Slingco Part No	Range		Lattice Length		Approx. Break Load	
	in	mm	in	mm	lb	kg
<b>SHORT LENGTH - GALVANISED STEEL</b>						
ZCS2734	0.50 - 0.62	13-16	11	280	5,600	2,540
ZCS2735	0.62 - 0.75	16-19	11	280	6,800	3,085
ZCS2736	0.75 - 1.00	19-25	20	508	6,800	3,085
ZCS2738	1.00 - 1.50	25-38	21	533	12,800	5,805
ZCS2739	1.50 - 2.00	38-50	25	635	16,400	7,440
ZCS2740	2.00 - 2.50	50-63	26	660	27,200	12,340
ZCS2741	2.50 - 3.00	63-76	28	711	33,000	14,970
ZCS2742	3.00 - 3.50	76-89	30	762	41,000	18,600
ZCS2743	3.50 - 4.00	89-102	32	813	43,000	19,510
ZCS2744	4.00 - 4.50	102-115	33	838	43,000	19,510
<b>STANDARD - LONGER LENGTH - GALVANISED STEEL</b>						
ZCS2745	0.50 - 0.62	13-16	16	406	5,600	2,540
ZCS2746	0.62 - 0.75	16-19	16	406	6,800	4,355
ZCS2747	0.75 - 1.00	19-25	32	812	9,600	3,085
ZCS2748	1.25 - 1.50	25-38	33	838	16,400	5,805
ZCS2749	1.50 - 2.00	38-50	34	863	16,400	7,440
ZCS2750	2.00 - 2.50	50-63	36	914	27,300	12,340
ZCS2751	2.50 - 3.00	63-76	38	965	33,000	14,970
ZCS2752	3.00 - 3.50	76-89	39	990	41,000	18,600
ZCS2753	3.50 - 4.00	89-102	41	1,041	43,000	19,510
ZCS2754	4.00 - 4.50	102-115	42	1,066	43,000	19,510
ZCS2755	4.50 - 5.00	115-127	58	1,473	43,000	19,510
ZCS2756	5.00 - 6.00	127-153	60	1,524	43,000	19,510
ZCS2757	6.00 - 7.00	153-178	66	1,676	43,000	19,510



**SPLICING GRIP - ROTATING SWIVEL LINK**



Slingco Rotating Swivel Link Grips are perfect for stringing replacement wire and cable on equipment and in drilling or rigging systems. Not recommended for use in overhead stringing applications. Use the existing cable as a pull wire to string the replacement cable. These grips are available with differently sized grips for each side. Call for assistance in selecting the proper grip. Link opens for easy installation and adjustment. Made of galvanized steel.

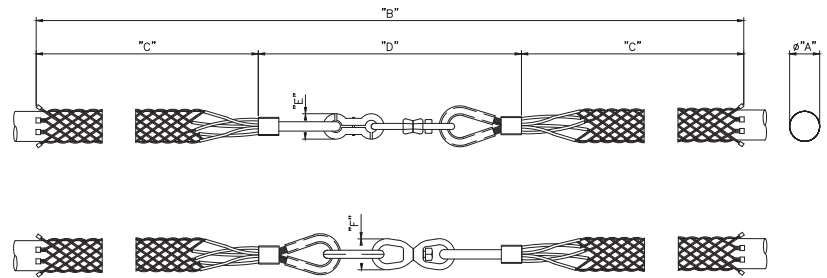

Slingco Part No	Range		Ø A Nominal		B Length		C Length		D Length		E Length		F Length		Approx. Break Load	
	in	mm	in	mm	in	mm	in	mm	in	mm	in	mm	in	mm	lb	kg
ZCS3493	0.25 - 0.50	6-13	0.37	9.5	100.0	2,542	44.3	1,127	11.3	288	0.87	22	1.25	32	2,400	1,089
ZCS3494	0.50 - 1.00	13-25	0.75	19	103.2	2,621	45.7	1,160	11.8	301	1.38	35	1.25	32	3,526	1,599
ZCS3495	1.00 - 1.50	25-38	1.25	32	104.5	2,654	45.7	1,160	13.1	334	1.61	41	1.61	41	5,070	2,300
ZCS3496	1.50 - 2.00	38-51	1.75	44.5	105.2	2,673	45.7	1,160	13.9	353	1.61	41	2.0	51	8,000	3,629
ZCS3497	2.00 - 2.75	51-70	2.38	60.5	105.2	2,673	45.7	1,160	13.9	353	1.61	41	2.0	51	10,000	4,537
ZCS3498	2.75 - 3.50	70-90	3.15	80	105.2	2,673	45.7	1,160	13.9	353	1.61	41	2.0	51	10,000	4,537
ZCS3499	3.50 - 4.25	89-108	3.87	98.5	108.4	2,753	45.7	1,200	13.9	353	1.61	41	2.0	51	10,000	4,537

**SPLICING GRIP - ROTATING BARREL**

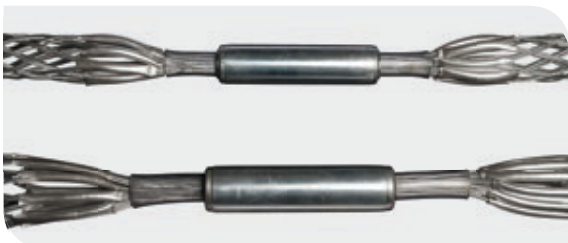

Slingco Rotating Barrel Swivel grips have a high capacity swivel that travels smoothly when being strung in straight line pulling.

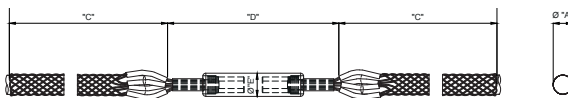

Slingco Part No	Range		Ø A Nominal		B Length		C Length		D Length		Ø E		Approx. Break Load	
	in	mm	in	mm	in	mm	in	mm	in	mm	in	mm	lb	kg
ZCS3505	0.25-0.50	6-13	0.37	9.5	66.1	1,680	29.7	755	6.7	170	0.9	23	4,400	1,964
ZCS3506	0.50-1.00	13-25	0.75	19	87.8	2,230	40.0	1,015	7.9	200	1.0	25.4	7,400	3,304
ZCS3507	1.00-1.50	25-38	1.25	32	79.9	2,030	35.2	895	9.5	240	1.4	36	10,000	4,530
ZCS3508	1.50-2.00	38-51	1.75	44.5	72.0	1,830	31.3	795	9.5	240	1.4	36	12,000	5,357
ZCS3509	2.00-2.75	51-70	2.38	60.5	85.8	2,180	37.0	940	11.8	300	1.6	41	16,000	7,142
ZCS3510	2.75-3.50	70-90	3.15	80	107.5	2,730	47.0	1,195	13.3	340	1.9	48.5	20,000	8,928
ZCS3511	3.50-4.25	89-108	3.87	98.5	104.3	2,650	44.5	1,130	15.3	390	1.9	48.5	24,000	10,714

**SPLICING GRIP - NON-ROTATING MULTI-WEAVE**



Slingco Splicing Grips are made from multi weave construction for temporary splicing of conductor and wire ropes as well as cable reinforcements. Made of galvanised steel.

Slingco Part No	Colour Code	Range		Lattice Length		Approx. Break Load	
		in	mm	in	mm	lb	kg
ZCS2552	Dark Green	0.25 - 0.49	6-12	63	1,574	7,000	3,175
ZCS2553	Brown	0.50 - 0.74	12-19	90	2,286	10,500	4,760
ZCS2446	Light Blue	0.75 - 0.99	19-25	90	2,286	14,100	6,395
ZCS2554	Gold	1.00 - 1.24	25-31	130	3,302	25,000	11,340
ZCS2547	Black	1.25 - 1.49	31-38	130	3,302	31,000	14,065
ZCS2555	Red	1.50 - 1.74	38-44	164	4,166	31,000	14,065
ZCS2556	Dark Blue	1.75 - 2.24	44-57	164	4,166	49,000	18,000

## SE TYPE - SINGLE EYE GRIP



Ideal for pulling light to medium loads; typical application - 'standard pull' of single or group of cables, where additional support is unnecessary, or if used in conjunction with other cable grips.

Slingco Part No	Range		Lattice Weave	Lattice Length		Overall Length		Approx. Break Load	
	in	mm		in	mm	in	mm	lb	kg
<b>SINGLE EYE STANDARD GRIP - GALVANISED</b>									
ZCS0320	0.25 - 0.50	10-13	Single	9	230	12	305	1,680	760
ZCS0321	0.50 - 0.75	13-19	Single	14	355	17	430	2,240	1,015
ZCS0322	0.75 - 1.00	19-25	Single	16	405	20	510	5,600	2,540
ZCS0323	1.00 - 1.50	25-38	Single	18	455	24	610	7,840	3,555
ZCS0324	1.50 - 2.00	38-50	Double	21	535	29	735	11,200	5,080
ZCS0325	2.00 - 2.50	50-63	Double	24	610	34	865	11,200	5,080
ZCS0326	2.50 - 3.50	63-89	Double	27	685	39	990	13,440	6,095
ZCS0327	3.50 - 4.50	89-115	Double	27	685	39	990	15,680	7,110
ZCS0821	4.50 - 5.50	115-140	Double	27	685	39	990	15,680	7,110
ZCS3574	5.31 - 6.30	135-160	Single	35.43	900	54.33	1,380	44,800	20,000
ZCS3575	6.33 - 7.48	161-190	Single	59.05	1,500	78.74	2,000	44,800	20,000
ZCS3576	7.51 - 8.66	191-220	Single	59.05	1,500	78.74	2,000	44,800	20,000
ZCS3577	8.70 - 9.84	221-250	Single	59.05	1,500	78.74	2,000	44,800	20,000
ZCS3578	9.88 - 11.81	251-300	Single	78.74	2,000	102.36	2,600	44,800	20,000
<b>SINGLE EYE STANDARD GRIP - 316 STAINLESS STEEL</b>									
ZCS1380	0.25 - 0.50	10-13	Single	9	230	12	305	1,344	610
ZCS1523	0.50 - 0.75	13-19	Single	14	355	17	430	1,792	810
ZCS1373	0.75 - 1.00	19-25	Single	16	405	20	510	4,480	2,030
ZCS1952	1.00 - 1.50	25-38	Single	18	455	24	610	6,272	2,845
ZCS1381	1.50 - 2.00	38-50	Double	21	535	29	735	8,960	4,065
ZCS1977	2.00 - 2.50	50-63	Double	24	610	34	865	8,960	4,065
ZCS1979	2.50 - 3.50	63-89	Double	27	685	39	990	10,752	4,875
ZCS1980	3.50 - 4.50	89-115	Double	27	685	39	990	12,544	5,690
ZCS1981	4.50 - 5.50	115-140	Double	27	685	39	990	12,544	5,690

## DE TYPE - DOUBLE EYE GRIP



Ideal for pulling light to medium loads; the main advantage over the single eye cable grip is the cable being pulled can be passed through the grip, several cable grips can be used to support over a calculated distance.

Slingco Part No	Range		Lattice Weave	Lattice Length		Overall Length		Approx. Break Load	
	in	mm		in	mm	in	mm	lb	kg
<b>DOUBLE EYE STANDARD GRIP - GALVANISED</b>									
ZCS0305	0.25 - 0.50	10-13	Single	9	230	12	305	1,680	760
ZCS0306	0.50 - 0.75	13-19	Single	14	355	17	430	2,240	1,015
ZCS0307	0.75 - 1.00	19-25	Single	16	405	20	510	5,600	2,540
ZCS0308	1.00 - 1.50	25-38	Single	18	455	24	610	7,840	3,555
ZCS0309	1.50 - 2.00	38-50	Double	21	535	29	735	11,200	5,080
ZCS0310	2.00 - 2.50	50-63	Double	24	610	34	865	11,200	5,080
ZCS0311	2.50 - 3.50	63-89	Double	27	685	39	990	13,440	6,095
ZCS0312	3.50 - 4.50	89-115	Double	27	685	39	990	15,680	7,110
ZCS0878	4.50 - 5.50	115-140	Double	27	685	39	990	15,680	7,110
ZCS3579	5.31 - 6.30	135-160	Double	39.37	1,000	63	1,600	44,800	20,000
ZCS3580	6.33 - 7.48	161-190	Double	59.05	1,500	82.67	2,100	60,480	27,000
ZCS3581	7.51 - 8.66	191-220	Double	59.05	1,500	82.67	2,100	60,480	27,000
ZCS3582	8.70 - 9.84	221-250	Double	59.05	1,500	82.67	2,100	60,480	27,000
ZCS3583	9.88 - 11.81	251-300	Double	78.75	2,000	106.29	2,700	60,480	27,000
<b>DOUBLE EYE STANDARD GRIP - 316 STAINLESS STEEL</b>									
ZCS0823	0.25 - 0.50	10-13	Single	9	230	12	305	1,344	610
ZCS1007	0.50 - 0.75	13-19	Single	14	355	17	430	1,792	810
ZCS0931	0.75 - 1.00	19-25	Single	16	405	20	510	4,480	2,030
ZCS1265	1.00 - 1.50	25-38	Single	18	455	24	610	6,272	2,845
ZCS3995	1.14 - 1.57	29-40	Double	50	1,270	62	1,575	35,000	15,625
ZCS1252	1.50 - 2.00	38-50	Double	21	535	29	735	8,960	4,065
ZCS0319	2.00 - 2.50	50-63	Double	24	610	34	865	8,960	4,065
ZCS0213	2.50 - 3.50	63-89	Double	27	685	39	990	10,752	4,875
ZCS4873	2.50 - 3.50	63-89	Double	70	1,778	80	2,032	13,500	6,027
ZCS4596	2.50 - 3.50	63-89	Triple	56	1,422	152	3,860	16,138	7,204
ZCS0332	3.50 - 4.50	89-115	Double	27	685	39	990	12,544	5,690
ZCS1982	4.50 - 5.50	115-140	Double	27	685	39	990	12,544	5,690
ZCS4869	4.50 - 5.50	115-140	Double	70	1,778	80	2,032	13,500	6,027

**OS TYPE – OFFSET EYE GRIP**



Similar to the SE Type single eye cable grip, but for when offset positioning is required. Excellent for pulling slack out of lines that have been pulled. May also be used for removing underground cables when end of cable is available.

Slingco Part No	Range		Lattice Weave	Lattice Length		Overall Length		Approx. Break Load	
	in	mm		in	mm	in	mm	lb	kg
<b>OFFSET EYE STANDARD GRIP - GALVANISED</b>									
ZCS1860	0.25 - 0.50	10-13	Single	9	230	12	305	1,680	760
ZCS1861	0.50 - 0.75	13-19	Single	14	355	17	430	2,240	1,015
ZCS1862	0.75 - 1.00	19-25	Single	16	405	20	510	5,600	2,540
ZCS1863	1.00 - 1.50	25-38	Single	18	455	24	610	7,840	3,555
ZCS1864	1.50 - 2.00	38-50	Double	21	535	29	735	11,200	5,080
ZCS1865	2.00 - 2.50	50-63	Double	24	610	34	865	11,200	5,080
ZCS1866	2.50 - 3.50	63-89	Double	27	685	39	990	13,440	6,095
ZCS1867	3.50 - 4.50	89-115	Double	27	685	39	990	15,680	7,110
ZCS1974	4.50 - 5.50	115-140	Double	27	685	39	990	15,680	7,110
<b>OFFSET EYE STANDARD GRIP - 316 STAINLESS STEEL</b>									
ZCS1986	0.25 - 0.50	10-13	Single	9	230	12	305	1,344	610
ZCS1987	0.50 - 0.75	13-19	Single	14	355	17	430	1,792	810
ZCS1988	0.75 - 1.00	19-25	Single	16	405	20	510	4,480	2,030
ZCS1989	1.00 - 1.50	25-38	Single	18	455	24	610	6,272	2,845
ZCS1990	1.50 - 2.00	38-50	Double	21	535	29	735	8,960	4,065
ZCS1991	2.00 - 2.50	50-63	Double	24	610	34	865	8,960	4,065
ZCS1992	2.50 - 3.50	63-89	Double	27	685	39	990	10,752	4,875
ZCS1993	3.50 - 4.50	89-115	Double	27	685	39	990	12,544	5,690
ZCS1994	4.50 - 5.50	115-140	Double	27	685	39	990	12,544	5,690
ZCS3994	5.50 - 7.00	140-180	Double	24	610	39	990	4,500	2,009
ZCS4069	8.0 - 9.0	203-229	Double	59	1,500	74	1,880	20,000	8,928

**L TYPE - LACE UP GRIP**



Ideal for pulling light to medium loads; the L-type is fitted to the cable being pulled by stitching it together, like a football. Mainly used where a 'typical' cable grip can't be fitted over a connector at the end of a cable. For use in pulling when the end is not accessible. The L Type is wrapped around the cable, then closed with the wire lace provided. See Lace Up instructions on page 34.

Slingco Part No	Range		Lattice Weave	Lattice Length		Overall Length		Approx. Break Load	
	in	mm		in	mm	in	mm	lb	kg
<b>LACE UP STANDARD GRIP - GALVANISED</b>									
ZCS1157	0.25 - 0.50	10-13	Single	9	230	12	305	1,680	760
ZCS0872	0.50 - 0.75	13-19	Single	14	355	17	430	2,240	1,015
ZCS0871	0.75 - 1.00	19-25	Single	16	405	20	510	5,600	2,540
ZCS0328	1.00 - 1.50	25-38	Single	18	455	24	610	7,840	3,555
ZCS0329	1.50 - 2.00	38-50	Double	21	535	29	735	11,200	5,080
ZCS0330	2.00 - 2.50	50-63	Double	24	610	34	865	11,200	5,080
ZCS0331	2.50 - 3.50	63-89	Double	27	685	39	990	13,440	6,095
ZCS0853	3.50 - 4.50	89-115	Double	27	685	39	990	15,680	7,110
ZCS1109	4.50 - 5.50	115-140	Double	27	685	39	990	15,680	7,110
ZCS4463	4.72 - 5.90	120-150	Triple	59	1,500	102	2,600	32,928	14,700
ZCS3270	7.90 - 8.70	200-220	Triple	78	2,000	102	2,600	71,680	32,000
ZCS3584	5.31 - 6.30	135-160	Double	39.37	1,000	63	1,600	38,080	17,000
ZCS3585	6.33 - 7.48	161-190	Double	59.05	1,500	82.67	2,100	38,080	17,000
ZCS3586	7.51 - 8.66	191-220	Double	59.05	1,500	82.67	2,100	38,080	17,000
ZCS3587	8.70 - 9.84	221-250	Double	59.05	1,500	82.67	2,100	38,080	17,000
ZCS3588	9.88 - 11.81	251-300	Double	78.74	2,000	106.29	2,700	38,080	17,000
<b>LACE UP STANDARD GRIP - 316 STAINLESS STEEL</b>									
ZCS1983	0.25 - 0.50	10-13	Single	9	230	12	305	1,344	610
ZCS1796	0.50 - 0.75	13-19	Single	14	355	17	430	1,792	810
ZCS1789	0.75 - 1.00	19-25	Single	16	405	20	510	4,480	2,030
ZCS1797	1.00 - 1.50	25-38	Single	18	455	24	610	6,272	2,845
ZCS1984	1.50 - 2.00	38-50	Double	21	535	29	735	8,960	4,065
ZCS2466	2.00 - 2.50	50-63	Double	24	610	34	865	8,960	4,065
ZCS0816	2.50 - 3.50	63-89	Double	27	685	39	990	10,752	4,875
ZCS5094	2.75 - 3.44	69-87	Multiple	55	1,390	81	2,063	40,000	17,857
ZCS1356	3.50 - 4.50	89-115	Double	27	685	39	990	12,544	5,690
ZCS2832	3.50 - 4.50	89-115	Triple	27	685	39	990	14,012	6,300
ZCS1355	4.50 - 5.50	115-140	Double	27	685	39	990	12,544	5,690
ZCS2833	4.50 - 5.50	115-140	Triple	27	685	39	990	16,128	7,315

# LIGHT-MEDIUM DUTY GRIPS

## OPEN ENDED GRIP



Ideal for joining two cables to form a continuous loop. Typical application: replacement of lift cables, where the old cable would be attached to the new one, and the cable then fed around with ease. Also used to temporarily splice cable and conductor where torsion forces are NOT an issue. Torsion should be released prior to splicing. Where torsion is present a swivel and two grips should be used.

Slingco Part No	Range		Lattice Weave	Lattice Length		Approx. Break Load	
	in	mm		in	mm	lb	kg
<b>OPEN ENDED STANDARD GRIP - GALVANIZED</b>							
ZCS0313	0.25 - 0.50	10-13	Single	15	380	1,680	760
ZCS6420	0.25 - 0.50	10-13	Double	22	559	3,500	1,588
ZCS0314	0.50 - 0.75	13-19	Single	24	610	2,240	1,015
ZCS6421	0.50 - 0.75	13-19	Double	30	762	4,500	2,040
ZCS6425	0.50 - 0.75	13-19	Multi	70	1,779	7,500	3,400
ZCS0315	0.75 - 1.00	19-25	Single	28	710	5,600	2,540
ZCS6422	0.75 - 1.00	19-25	Double	30	762	8,000	3,630
ZCS6426	0.75 - 1.00	19-25	Multi	80	2,032	11,800	5,352
ZCS0316	1.00 - 1.50	25-38	Single	32	815	7,840	3,555
ZCS6423	1.00 - 1.50	25-38	Double	36	915	10,000	4,537
ZCS6427	1.00 - 1.50	25-38	Multi	90	2,285	20,000	9,070
ZCS0317	1.50 - 2.00	38-50	Double	36	915	11,200	5,080
ZCS0318	2.00 - 2.50	50-63	Double	42	1,065	11,200	5,080
ZCS1158	2.50 - 3.50	63-89	Double	48	1,220	13,440	6,095
ZCS1159	3.50 - 4.50	89-115	Double	54	1,370	15,680	7,110
ZCS6424	4.25 - 4.88	108-124	Triple	55	1,400	19,500	8,847
ZCS1975	4.50 - 5.50	115-140	Double	54	1,370	15,680	7,110
<b>OPEN ENDED STANDARD GRIP - 316 STAINLESS STEEL</b>							
ZCS1995	0.25 - 0.50	10-13	Single	15	380	1,344	610
ZCS1996	0.50 - 0.75	13-19	Single	24	610	1,792	810
ZCS1997	0.75 - 1.00	19-25	Single	28	710	4,480	2,030
ZCS1998	1.00 - 1.50	25-38	Single	32	815	6,272	2,845
ZCS1999	1.50 - 2.00	38-50	Double	36	915	8,960	4,065
ZCS2000	2.00 - 2.50	50-63	Double	42	1,065	8,960	4,065
ZCS2001	2.50 - 3.50	63-89	Double	48	1,220	10,752	4,875
ZCS2002	3.50 - 4.50	89-115	Double	54	1,370	12,544	5,690
ZCS2003	4.50 - 5.50	115-140	Double	54	1,370	12,544	5,690

## FIBRE OPTIC CABLE GRIP



Dual weave design from galvanised wire rope. Used for the installation of fibre optic cables for either overhead or underground applications. Made of galvanised steel.

Slingco Part No	Range		Lattice Length		Overall Length		Approx. Break Load	
	in	mm	in	mm	in	mm	lb	kg
ZCS2008	0.11 - 0.23	2.5 - 5.6	11	265	18	455	950	455
ZCS2009	0.21 - 0.36	5.3 - 9.2	15	370	22	560	1,650	560
ZCS2010	0.32 - 0.49	8.1 - 12.5	19	470	27	690	2,200	690
ZCS2011	0.42 - 0.62	10.7 - 15.8	20	515	29	735	2,750	735
ZCS2012	0.53 - 0.75	13.5 - 19.1	23	595	32	815	3,700	815
ZCS2013	0.64 - 0.88	16.3 - 22.4	25	645	34	865	4,250	865
ZCS2014	0.75 - 1.00	19.1 - 25.5	27	720	37	940	4,250	940

**CAN'T FIND THE SPECIFICATION YOU NEED?**

Call or email for full ranges plus custom manufacture options

**01706 855558**

sales@slingco.com

Designed to fit the typical European range of cables, and with a longer lattice length, these grips are ideal for pulling medium to heavy loads. Made of galvanised steel.

**FLEXIBLE & THIMBLE EYE GRIP - SINGLE EYE**



This grip has a flexible eye construction – and is also available with a reinforced thimble eye.

Flexible Eye	Thimble Eye		Range		Lattice Length		Overall Length		Approx. Break Load	
			mm	in	mm	in	mm	in	kg	lb
ZCS0824	ZCS3133	Single	15-20	0.59-0.79	1,220	48	1,358	53.5	1,240	2,730
ZCS0825	ZCS3134	Single	20-30	0.79-1.18	1,250	49	1,358	53.5	1,530	3,370
ZCS0826	ZCS3135	Double	20-30	0.79-1.18	1,250	49	1,393	55	1,990	4,380
ZCS0827	ZCS3136	Single	30-40	1.18-1.57	1,250	49	1,393	55	2,550	5,620
ZCS0828	ZCS3137	Double	30-40	1.18-1.57	1,250	49	1,652	65	3,060	6,740
ZCS0829	ZCS3138	Double	40-50	1.57-1.97	1,500	59	1,661	65.5	5,930	13,060
ZCS0830	ZCS3139	Double	50-60	1.97-2.36	1,500	59	1,750	69	6,630	14,610
ZCS0831	ZCS3140	Double	60-70	2.36-2.76	1,500	59	1,750	69	7,790	17,160
ZCS0832	ZCS3141	Double	70-90	2.76-3.54	1,500	59	1,750	69	8,110	17,870
ZCS0833	ZCS3142	Double	90-110	3.54-4.33	1,500	59	1,750	69	11,830	26,070
ZCS0834	ZCS3143	Double	110-130	4.33-5.12	1,500	59	1,750	69	11,830	26,070
ZCS0835	ZCS3144	Double	120-150	4.72-5.91	1,500	59	1,750	69	12,750	28,100
ZCS0836	ZCS3145	Double	140-180	5.51-7.09	1,500	59	1,750	69	12,750	28,100



Slingco Part No	Range in	Range mm	Lattice Length		Approx. Break Load	
			in	mm	lb	kg
<b>SHORTER LENGTH</b>						
ZCS4783	2.36 - 2.75	60 - 70	43	1,096	17,450	7,790
ZCS4784	2.75 - 3.54	70 - 90	43	1,096	18,166	8,110
ZCS4785	3.54 - 4.33	90 - 110	43	1,096	26,500	11,830
ZCS4786	4.33 - 5.11	110 - 130	43	1,096	26,500	11,830
ZCS4787	4.72 - 5.90	120 - 150	43	1,096	28,560	12,750

**FLEXIBLE & THIMBLE EYE GRIP - DOUBLE EYE**



This grip has a double eye construction allowing the cables being pulled to pass through the grip. Available with flexible eye or reinforced thimble eye.

Flexible Eye	Thimble Eye		Range		Lattice Length		Overall Length		Approx. Break Load	
			mm	in	mm	in	mm	in	kg	lb
ZCS0837	ZCS3146	Single	15-20	0.59-0.79	1,250	49	1,500	59	1,240	2,730
ZCS0838	ZCS3147	Single	20-30	0.79-1.18	1,250	49	1,500	59	1,530	3,370
ZCS0839	ZCS3148	Double	20-30	0.79-1.18	1,250	49	1,500	59	1,990	4,380
ZCS0840	ZCS3149	Single	30-40	1.18-1.57	1,250	49	1,500	59	2,550	5,620
ZCS0841	ZCS3150	Double	30-40	1.18-1.57	1,250	49	1,500	59	3,060	6,740
ZCS0842	ZCS3151	Double	40-50	1.57-1.97	1,500	59	1,750	69	5,930	13,060
ZCS0843	ZCS3152	Double	50-60	1.97-2.36	1,500	59	1,750	69	6,630	14,610
ZCS0844	ZCS3153	Double	60-70	2.36-2.76	1,500	59	1,750	69	7,790	17,160
ZCS0846	ZCS3154	Double	70-90	2.76-3.54	1,500	59	1,750	69	8,110	17,870
ZCS0847	ZCS3155	Double	90-110	3.54-4.33	1,500	59	1,750	69	11,830	26,070
ZCS0848	ZCS3156	Double	110-130	4.33-5.12	1,500	59	1,750	69	11,830	26,070
ZCS0849	ZCS3157	Double	120-150	4.72-5.91	1,500	59	1,750	69	12,750	28,100
ZCS0850	ZCS3158	Double	140-180	5.51-7.09	1,500	59	1,750	69	12,750	28,100

# NON-METALLIC (ARAMID) GRIPS

Ideal for fibre optic applications, offshore or for a multitude of uses in the electrical industry; dramatically improved weight to break ratio. Slingco's non-metallic pulling grips are made of a high-strength, non-metallic aramid fibre, with UV protective coating; they are suitable for pulling both single cable and cable bundles. These woven mesh grips offer a non-metallic alternative to steel. Non-metallic material is easy to work with even without gloves.

## NS – NON-METALLIC (ARAMID) SINGLE EYE GRIP



Slingco Part No	Range		Lattice Length		Approx. Break Load	
	in	mm	in	mm	lb	kg
<b>SINGLE EYE SINGLE WEAVE NON-METALLIC GRIP</b>						
ZCS1040	0.38 - 0.75	10 - 20	24	600	2,460	1,115
ZCS1022	0.75 - 1.25	20 - 30	24	600	3,580	1,620
ZCS2923	1.00 - 1.50	25 - 36	24	600	3,580	1,620
ZCS1041	1.25 - 1.50	30 - 40	24	600	4,920	2,230
ZCS1042	1.50 - 2.00	40 - 50	24	600	5,820	2,640
<b>SINGLE EYE DOUBLE WEAVE NON-METALLIC GRIP</b>						
ZCS1023	1.25 - 1.50	30 - 40	24	600	9,860	4,470
ZCS1024	1.50 - 2.00	40 - 50	24	600	11,880	5,390
ZCS1179	2.00 - 2.50	50 - 65	24	600	15,900	7,210
ZCS1180	2.50 - 3.00	65 - 80	24	600	15,900	7,210
ZCS1181	3.00 - 4.00	80 - 100	37	940	15,900	7,210
ZCS4079	4.00 - 5.00	102 - 127	120	3,048	15,900	7,210

## ND – NON-METALLIC (ARAMID) DOUBLE EYE GRIP



Slingco Part No	Range		Lattice Length		Approx. Break Load	
	in	mm	in	mm	lb	kg
<b>DOUBLE EYE SINGLE WEAVE NON-METALLIC GRIP</b>						
ZCS1148	0.38 - 0.75	10 - 20	24	600	2,460	1,115
ZCS1176	0.75 - 1.25	20 - 30	24	600	3,580	1,620
ZCS2922	1.00 - 1.50	25 - 40	24	600	3,580	1,620
ZCS1177	1.25 - 1.50	30 - 40	24	600	4,920	2,230
ZCS1178	1.50 - 2.00	40 - 50	24	600	5,820	2,640
<b>DOUBLE EYE DOUBLE WEAVE NON-METALLIC GRIP</b>						
ZCS1182	1.25 - 1.50	30 - 40	24	600	9,860	4,470
ZCS1183	1.50 - 2.00	40 - 50	24	600	11,880	5,390
ZCS1184	2.00 - 2.50	50 - 65	24	600	15,900	7,210
ZCS1185	2.50 - 3.00	65 - 80	24	600	15,900	7,210
ZCS1186	3.00 - 4.00	80 - 100	32	800	15,900	7,210
ZCS3813	4.00 - 5.00	102 - 127	60.6	1,540	15,900	7,210

## NO - NON-METALLIC (ARAMID) OFFSET EYE GRIP



Slingco Part No	Range		Lattice Length		Approx. Break Load	
	in	mm	in	mm	lb	kg
<b>SINGLE OFFSET EYE SINGLE WEAVE NON-METALLIC GRIP</b>						
ZCS2810	0.38 - 0.75	10 - 20	24	600	2,460	1,115
ZCS2811	0.75 - 1.25	20 - 30	24	600	3,580	1,620
ZCS2921	1.00 - 1.50	25 - 40	24	600	3,580	1,620
ZCS2812	1.25 - 1.50	30 - 40	24	600	4,920	2,230
ZCS2813	1.50 - 2.00	40 - 50	24	600	5,820	2,640
<b>SINGLE OFFSET EYE DOUBLE WEAVE NON-METALLIC GRIP</b>						
ZCS2814	1.25 - 1.50	30 - 40	24	600	9,860	4,470
ZCS2815	1.50 - 2.00	40 - 50	24	600	11,880	5,390
ZCS2816	2.00 - 2.50	50 - 65	24	600	15,900	7,210
ZCS2817	2.50 - 3.00	65 - 80	24	600	15,900	7,210
ZCS2818	3.00 - 4.00	80 - 100	34	860	15,900	7,210

## MARINE GRIPS



These speciality grips are extremely heavy duty and suitable for large underwater pulls, plus other applications in the oil and gas industries. Galvanised steel construction for heavy duty large diameter pulls. Applications include underwater cable installation. Available in single eye, double eye lace closing and double eye. Sizes range from 4 inches to over 20 inches. Manufactured to order.

Slingco Part No	Range		Lattice length		Approx. Break Load	
	in	mm	in	mm	lb	kg
<b>SINGLE EYE</b>						
ZCS3525	4 - 5	102-127	94	2,360	100,000	45,370
ZCS3526	5 - 6	127-152	94	2,360	105,000	47,640
ZCS3527	6 - 8	152-203	94	2,360	112,000	50,815
ZCS3528	8 - 10	203-255	94	2,360	138,000	62,600
ZCS3529	10 - 12	255-305	94	2,360	138,000	62,600
ZCS3530	12 - 14	305-355	94	2,360	138,000+	62,600+
ZCS3531	14 - 16	355-406	118.11	2,950	138,000+	62,600+
ZCS3532	16 - 18	406-457	131.79	3,290	138,000+	62,600+
ZCS3533	18 - 20	457-508	157.48	3,940	138,000+	62,600+
ZCS3534	20 - 23	508-584	196.85	4,920	138,000+	62,600+
<b>DOUBLE EYE</b>						
ZCS3535	4 - 5	102-127	94	2,360	123,000	55,800
ZCS3536	5 - 6	127-152	94	2,360	123,000	55,800
ZCS3537	6 - 8	152-203	94	2,360	127,500	57,850
ZCS3538	8 - 10	203-255	94	2,360	156,500	71,000
ZCS3539	10 - 12	255-305	94	2,360	156,500	71,000
ZCS3540	12 - 14	305-355	94	2,360	156,500+	71,000
ZCS3541	14 - 16	355-406	118.11	2,950	156,000+	71,000+
ZCS3542	16 - 18	406-457	131.79	3,290	156,500+	71,000+
ZCS3543	18 - 20	457-508	157.48	3,940	156,500+	71,000+
ZCS3544	20 - 23	508-584	196.85	4,920	156,500+	71,000+
<b>DOUBLE EYE LACE UP</b>						
ZCS3545	4 - 5	102-127	94	2,360	123,000	55,800
ZCS3546	5 - 6	127-152	94	2,360	123,000	55,800
ZCS3547	6 - 8	152-203	94	2,360	127,500	57,850
ZCS3548	8 - 10	203-255	94	2,360	156,500	71,000
ZCS3549	10 - 12	255-305	94	2,360	156,500	71,000
ZCS3550	12 - 14	305-355	94	2,360	156,500+	71,000
ZCS3551	14 - 16	355-406	118.11	2,950	156,000+	71,000+
ZCS3552	16 - 18	406-457	131.79	3,290	156,500+	71,000+
ZCS3553	18 - 20	457-508	157.48	3,940	156,500+	71,000+
ZCS3554	20 - 23	508-584	196.85	4,920	156,500+	71,000+

## HOSE ARMOUR GRIPS FOR HOSE PROTECTION



Protect hydraulic and other hoses in harsh environments. The wire mesh covering minimises damage to hose exterior from rocks, metal and other hazards common on construction and oil field sites. Hose armour kits come complete with clips for securing armour.

Slingco Part No	Range		Lattice Weave	Lattice Length	
	in	mm		in	mm
<b>OPEN ENDED STANDARD GRIP GALVANISED</b>					
ZCS0318HA	2.00 - 2.50	50-63	Double	42	1,065
ZCS1158HA	2.50 - 3.50	63-89	Double	48	1,220
ZCS1159HA	3.50 - 4.50	89-115	Double	54	1,370
ZCS1975HA	4.50 - 5.50	115-140	Double	54	1,370

**CAN'T FIND THE SPECIFICATION YOU NEED?**

Call or email for full ranges plus custom manufacture options

**01706 855558**

sales@slingco.com

## HEAVY DUTY HOSE RESTRAINT GRIPS / WHIPSOCKS



Safety restraining system designed to prevent whipping in the event of a pressurised hose becoming detached from its fitting.

Slingco part no.		Range		Lattice Length		Lattice Weave	Approx. Break Load	
		in	mm	in	mm		lb	kg
<b>DOUBLE THIMBLE EYE - GALVANISED STEEL</b>								
ZCS5363	Thimble eye	1.0 - 1.5	25 - 38	26	660	Double	11,000	4,911
ZCS5364	Thimble eye	1.5 - 2.5	38 - 63	40	1,016	Double	20,000	8,928
ZCS5365	Thimble eye	2.5 - 3.5	63 - 89	42	1,067	Double	22,000	9,821
ZCS5366	Thimble eye	3.5 - 4.5	89 - 114	44	1,118	Double	27,000	12,053
ZCS5367	Thimble eye	4.5 - 5.5	114 - 140	48	1,219	Double	31,000	13,839
ZCS6012	Thimble eye	5.5 - 7.0	140 - 180	60	1,524	Double	50,000	22,685
ZCS5529	Thimble eye	7.0 - 9.25	180 - 240	78	2,000	Triple	66,000	30,000
<b>DOUBLE THIMBLE EYE - 316 STAINLESS STEEL</b>								
ZCS5650	Thimble eye	1.0 - 1.5	25 - 38	26	660	Double	7,700	3,437
ZCS5651	Thimble eye	1.5 - 2.5	38 - 63	40	1,016	Double	14,000	6,250
ZCS5652	Thimble eye	2.5 - 3.5	63 - 89	42	1,067	Double	15,400	6,874
ZCS5653	Thimble eye	3.5 - 4.5	89 - 114	44	1,118	Double	18,900	8,437
ZCS5654	Thimble eye	4.5 - 5.5	114 - 140	48	1,219	Double	21,700	9,687
ZCS6000	Thimble eye	5.5 - 7.0	140 - 180	60	1,524	Double	35,000	15,880
<b>DOUBLE EYE MULTIWEAVE - MAX STRENGTH - 316 STAINLESS STEEL</b>								
ZCS3995	Thimble eye	1.14 - 1.57	29 - 40	50	1,270	Double	35,000	15,625
ZCS3295	Flex eye	2.75 - 3.44	70 - 87	58	1,460	Multiple	49,000	22,230
ZCS3254	Flex eye	3.00 - 3.50	76 - 89	58	1,460	Multiple	39,200	17,785
ZCS6004	Flex eye	3.50 - 4.75	89 - 120	58	1,460	Multiple	50,000	22,320
ZCS3414	Flex eye	4.75 - 5.10	120 - 130	78	1,981	Multiple	106,000	48,095

## SPECIALITY HOSE RESTRAINT GRIPS / WHIPSOCKS



### Y Type Threaded Bolt Hose Grip - 316 Stainless Steel

Slingco part no.	Size range inches (mm)	Ø A mean inches (mm)	Ø B inches (mm)	C inches (mm)	D inches (mm)	Ø E inches (mm)	Approx. Break Load lb (kg)
ZCS5422	0.25 - 0.5 (6 - 13)	0.37 (9.5)	4.10 (1,041)	29.0 (737)	12.0 (305)	5/16 BSW (18 TPI)	2,600 (1,161)
ZCS5423	0.5 - 0.75 (13 - 19)	0.62 (16)	39.0 (991)	27.0 (686)	12.0 (305)	5/16 BSW (18 TPI)	3,500 (1,562)
ZCS5424	1.0 - 1.5 (25 - 38)	1.25 (32)	43.0 (1,092)	31.0 (787)	12.0 (305)	1/2 BSW (12 TPI)	12,000 (5,357)

### U Type Universal Eye Hose Grip - 316 Stainless Steel

Slingco part no.	Size range inches (mm)	Ø A mean inches (mm)	Ø B inches (mm)	C inches (mm)	Approx. Break Load lb (kg)
ZCS5431	0.25 - 0.5 (6 - 13)	0.37 (9.5)	29.0 (737)	29.0 (737)	2,600 (1,161)
ZCS5432	0.5 - 0.75 (13 - 19)	0.62 (16)	27.0 (686)	27.0 (686)	3,500 (1,562)
ZCS5433	1.0 - 1.5 (25 - 38)	1.25 (32)	31.0 (787)	31.0 (787)	12,000 (5,357)

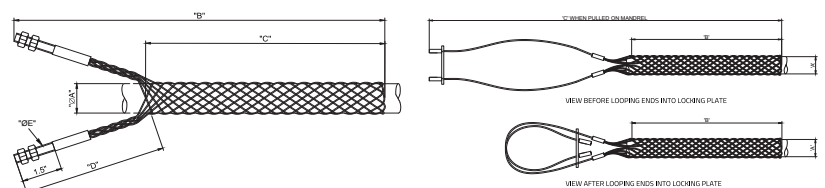



## LINE PULLING SWIVELS

Swivels designed for use in stringing high tension wires for electrical transmission and distribution. Swivels are important in pulling when the lines develop torsion during the installation. This torsion must be released. Use of a swivel will release torque and prevent it from reaching dangerous levels, which can cause damage to the cable or grip.

Slingco also offers a 'bullet nose' style swivel designed for underground and overhead applications.

All swivels are stringently quality tested and inspected to ensure optimum performance and reliability.



STANDARD ENDS

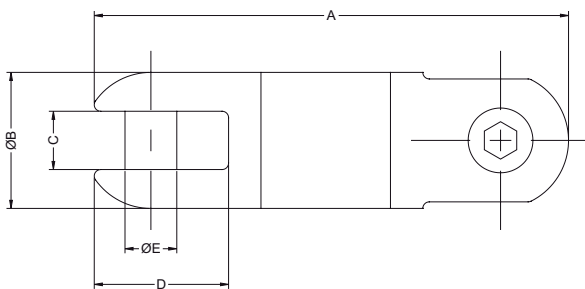

BULLET NOSE

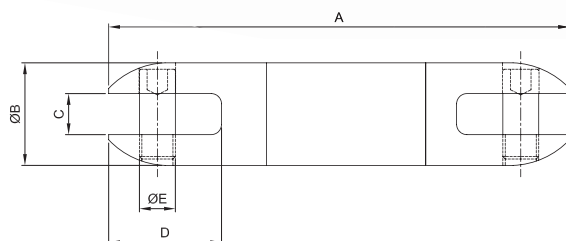

Slingco part no.	Safe working load lb (kg)		A in (mm)	Ø B in (mm)	C in (mm)	D in (mm)	Ø E in (mm)
	Underground	Overhead					
<b>LINE PULLING SWIVEL – STANDARD ENDS</b>							
ZSW2091	2,250 (1,015)	1,350 (610)	3 3/8 (86)	7/8 (22)	3/8 (10)	7/8 (22)	5/16 (8)
ZSW2092	3,500 (1,590)	2,100 (955)	4 (99)	1 (25)	7/16 (11)	1 1/16 (26)	3/8 (10)
ZSW2093	5,000 (2,240)	3,000 (1,345)	4 15/16 (126)	1 1/4 (32)	9/16 (14)	1 1/4 (32)	3/8 (10)
ZSW2094	7,000 (3,170)	4,200 (1,900)	5 3/16 (132)	1 3/8 (35)	9/16 (14)	1 13/32 (36)	1/2 (12.5)
ZSW2096	10,000 (4,530)	6,000 (2,700)	6 3/16 (157)	1 5/8 (41)	45/64 (18)	1 3/4 (45)	13/20 (16.5)
ZSW2097	15,000 (6,730)	9,000 (4,030)	7 5/16 (186)	2 3/32 (53)	25/32 (20)	2 1/8 (54)	23/32 (18)

<b>LINE PULLING SWIVEL – BULLET NOSE</b>							
ZSW2649	4,000 (1,815)	2,400 (1,085)	4 3/4 (120.7)	1 1/4 (31.8)	19/32 (15.1)	1 3/16 (30.2)	3/8 (9.5)
ZSW2929	8,000 (3,630)	4,800 (2,175)	5 3/8 (136.5)	1 1/2 (38.1)	5/8 (15.9)	1 3/8 (34.9)	7/16 (11.1)
ZSW6122	10,000 (4,530)	6,000 (2,700)	7 1/32 (178.3)	1 7/8 (47.6)	6 1/16 (154)	5/8 (15.9)	3/4 (19.1)
ZSW6123	16,000 (7,142)	9,600 (4,355)	10 1/8 (257.73)	2 7/16 (62)	8 3/4 (222)	1 1/8 (28.5)	1 (25.4)
ZSW2857	30,000 (13,610)	18,000 (8,165)	11 1/8 (282.6)	2 1/2 (63.5)	1 (25.4)	2 3/4 (69.9)	7/8 (22.2)

3:1 factor of safety used, based on the ultimate load for underground use  
5:1 factor of safety used, based on the ultimate load for overhead use

### Swivel and Cable Grip match-up

Revolving Eye	Flexible Eye MU	Approx. breaking strength of cable grip lb (kg)	Cable grip colour code	Size range O.D. inches (mm)	Recommended swivel	Safe working load of swivel lb (kg)
---------------	-----------------	---	------------------------	-----------------------------	--------------------	-------------------------------------

<b>LINE PULLING SWIVEL – STANDARD ENDS</b>						
ZCS2177	ZCS1710	7,000 (3,175)	Dark green	0.25 - 0.50 (6 - 12)	ZSW2092	3,500 (1,590)
ZCS2178	ZCS1711	10,500 (4,760)	Brown	0.50 - 0.75 (12 - 19)	ZSW2093	5,000 (2,240)
ZCS2179	ZCS1712	14,100 (6,395)	Light blue	0.75 - 1.00 (19 - 25)	ZSW2093	5,000 (2,240)
ZCS2180	ZCS1713	25,000 (11,340)	Gold	1.00 - 1.25 (25 - 32)	ZSW2096	10,000 (4,530)
ZCS2181	ZCS1714	31,000 (14,065)	Black	1.25 - 1.50 (32 - 38)	ZSW2096	10,000 (4,530)
ZCS2182	ZCS1715	31,000 (14,065)	Red	1.50 - 1.75 (38 - 44)	ZSW2096	10,000 (4,530)
ZCS2183*	ZCS1716†	43,000* 49,000† (19,510) (22,230)	Dark blue	1.75 - 2.25 (44 - 57)	ZSW2097	15,000 (6,730)

<b>LINE PULLING SWIVEL – BULLET NOSE</b>						
ZCS2177	ZCS1710	7,000 (3,175)	Dark green	0.25 - 0.50 (6 - 12)	ZSW2649	4,000 (1,810)
ZCS2178	ZCS1711	10,500 (4,760)	Brown	0.50 - 0.75 (12 - 19)	ZSW2929	5,000 (2,240)
ZCS2179	ZCS1712	14,100 (6,395)	Light blue	0.75 - 1.00 (19 - 25)	ZSW2929	5,000 (2,240)
ZCS2180	ZCS1713	25,000 (11,340)	Gold	1.00 - 1.25 (25 - 32)	ZSW6122	10000 (4,530)
ZCS2181	ZCS1714	31,000 (14,065)	Black	1.25 - 1.50 (32 - 38)	ZSW6122	10000 (4,530)
ZCS2182	ZCS1715	31,000 (14,065)	Red	1.50 - 1.75 (38 - 44)	ZSW6122	10000 (4,530)
ZCS2183*	ZCS1716†	43,000* 49,000† (19,510) (22,230)	Dark blue	1.75 - 2.25 (44 - 57)	ZSW6123	16,000 (7,257)

The above is intended as a rough guide. The recommended working load should be determined by the competent person(s) using the cable grip and/or Slingco swivel.

**SAFETY NOTE:** These swivels are designed for straight line pulling and will not support side loads as would be encountered traveling over a bull wheel. Swivel selection should be based on pulling line diameter, grip size, opening dimensions, pin sizes, working load, and sheave groove diameter. Swivels are not designed for general lifting.

## CONTROL AND GUIDANCE PRODUCTS

In addition to our ranges of pulling and support grips we also offer a number of products to assist with control and guidance. From a simple cable laying roller to our innovative Load Sensing Device, these accessory products assist pulling and support both overground and underground.

- Power cable support, sag correction, and prevention of cable twisting
- Feed tubes for easy cable insertion
- Access to active pull data in real time with the Slingco Load Sensing Device
- Underground cable stringing guidance

### ANTI ROTATIONAL DEVICE



The device prevents the cable from twisting as it travels over pulling blocks. Left uncontrolled, the optical cable's delicate glass fibres could be permanently damaged during installation.

- Stops cables from twisting as they pass over pulling blocks
- For use with fibre optic and OPGW cable
- Prevents irreparable damage to delicate fibre optics caused by cable twists during installation
- The ARD has weighted attachments that hang down while stringing, keeping the ARD vertical to stop cable rotation
- ARD attachments collapse in line, enabling them to travel easily over pulling blocks

Specification	
Slingco Part No.	ZAD3799
Overall Length	8839mm (29') approx.
Working load (@3:1 Safety Factor)	2268 kg (5,000 lbs)
Length of Attachments	2438mm (8') Approx.
Weight of Attachment	14 lbs each Approx.

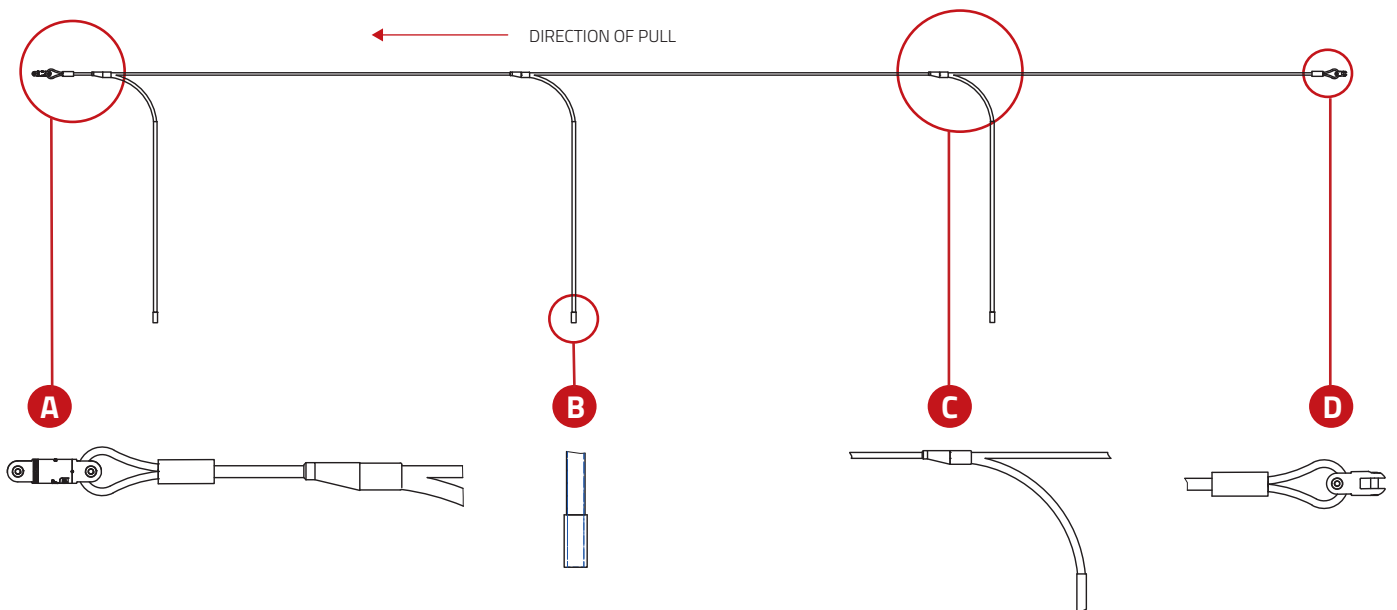

## LOAD SENSING DEVICE FOR TRANSMISSION APPLICATIONS



Operating within safe working loads is a critical part of OHL conductor pulling under tension - the Slingco Load Sensing Device (LSD) puts real-time pulling information at your fingertips via our unique wireless interface.

Uniquely, Slingco's Load Sensing Device (LSD) offers easy and convenient access to load pulling information in real time, giving you peace of mind when out in the field.

- See and record pulling load data in real time
- Analyse stored pull information to show that safe working loads have not been exceeded
- Use anywhere a specific load/tension requirement has been specified

**HOW IT WORKS**

First of all the LSD is attached to the OHL conductor. It responds automatically when the remote computer software is activated.

Then, with the receiver attached to laptop or tablet, the software's 'Live view' displays real-time data when the LSD is in an active pull.

Throughout the pull, the LSD continues to record the load and, using its in-built antenna, transmits information to the receiver via wireless signal with a range of 6000ft (line of sight).

**ACCESS STORED DATA**

In addition to displaying live data, the LSD also stores the information, allowing the contractor or utility to see and show whether loads were exceeded during pulls. This can also be useful if issues arise or to analyse where hang-ups happen.

**GOING UNDERGROUND WITH RECORDED DATA**

The LSD can also be used in underground applications. At present, calculations of expected loads can't account for things like debris in conduits, nor be sure that all turns are as documented. The LSD helps improve underground pull calculations by comparing what was designed to what actually happened. New pulls then become easier to calculate.

**OTHER USES**

There are numerous other applications for the LSD, for example when securing guy anchors or sagging in a line. In fact, it can be used anywhere a specific load/tension has been specified.



ACCURATELY VIEW AND RECORD  
LOAD PULLING DATA IN REAL TIME

PEACE OF MIND AT YOUR  
FINGERTIPS



- Maximum load limit: 20,000 lbf
- Range: 6,000ft (line of sight)
- Battery life: 48 hrs max.
- All critical event data is 'black box' secure
- Supplied in a customised, protective case rated at IP67
- System maintenance contracts available

## TRANSMISSION LINE STRINGING

Designed specifically for installing large diameter electrical transmission conductor, these units are available in sheave diameters to suit all needs – 22”, 28”, 36” and 42” – with models suitable for full-tension stringing or helicopter stringing.

Slingco pulleys are gravity die cast from high specification aluminium, providing the cast components with the perfect blend of strength, durability and value for money.

The pulleys are lined with a high performance polyurethane coating. This provides a resilient but supportive surface that minimises wear on the conductor. It also maintains peripheral support to minimise conductor distortion under tension loads and, in doing so, maximize the working life of the stringing pulleys.

Stringing pulleys feature high quality low-friction bearings to minimise rolling resistance and alleviate any potential deformation of the electrical conductor.

All cast component parts benefit from high-tolerance CNC machining and, where appropriate, heat-treatment, providing class leading strength and durability.

### HELICOPTER VERSION

This model, designed for stringing use in conjunction with helicopters, incorporates a spring-loaded gate at the side of the frame, facilitating one-way passage of the conductor into its operational position on the pulley.

### 7” UNIVERSAL PULLEY

The model is a lightweight but exceptionally rugged, reliable, and durable distribution stringing pulley. Used in conjunction with purpose-designed accessories, it has proven extremely popular with utility operators and their contractors for the exceptional versatility it offers in terms of installation applications and locations. Its low-friction bearings render high efficiency, which helps to maximize stringing distances while minimizing pulling tensions and reducing loads on stringing equipment.

Like the larger models in our range, the pulley is gravity die cast from A356-T6 aluminium to deliver the optimum combination of strength and durability.



**EACH PULLEY IS DESIGNED TO DELIVER MAXIMUM PERFORMANCE**

**PROVIDING STRENGTH, USABILITY AND LONGEVITY**



**UNFORTUNATELY, THIS PRODUCT IS NOT AVAILABLE IN THE USA**



	Pulley only kg (lbs)	Full frame kg (lbs)	Helicopter frame kg (lbs)
<b>PULLEY SIZE 22"</b>			
Part number	ZAB3322	ZAB3320	ZAB4012
SWL (lb)	3628.7 (8000)	3628.7 (8000)	3628.7 (8000)
<b>PULLEY SIZE 28"</b>			
Part number	ZAB3561	ZAB4001	ZAB4002
SWL (lb)	3628.7 (8000)	3628.7 (8000)	3628.7 (8000)
<b>PULLEY SIZE 36"</b>			
Part number	ZAB3803	ZAB3999	ZAB4000
SWL (lb)	6803.9 (15000)	6803.9 (15000)	6803.9 (15000)
<b>ALUMINIUM PULLEY 7"</b>			
Part number		ZAB4004	ZAB4344
SWL (lb)		1134 (2500)	1134 (2500)
<b>UL COATED PULLEY 7"</b>			
Part number		ZAB4005	ZAB4345
SWL (lb)		1134 (2500)	1134 (2500)
<b>PLASTIC PULLEY 7"</b>			
Part number		ZAB4006	ZAB4346
SWL (lb)		1134 (2500)	1134 (2500)

## PULLEY BUNDLE



Slingco Pulley Bundles are designed to facilitate the installation of multiple cables. Available in standard diameters of 28" (711mm) and 36" (914mm), though bespoke configurations can be produced via our Engineering Department, with fully customised bundles designed from scratch to suit your application.

- Structural aluminium frame to reduce overall weight
- Customised gate opening feature for ease of installation
- Symmetrical design ensures balance through the pull
- Sheaves are evenly spaced through the block
- Independently type tested to ensure compliance with the Slingco specifications

## BULL WHEEL



Lightweight and portable, the Slingco Bull Wheel can be assembled by one person. It can also be dismantled and passed through a 3ft x 3ft access opening in the top of a concrete vault.

Slingco has developed an 8ft wheel for stringing cables around 180° within underground vaults.

The rotating wheel allows operators to impose a bend of up to  $\varnothing 4$  inches on conductor wire inside an underground concrete 'vault'.

Supplied with a two point wall fixing, the wheel is mounted on an upright post that allows height adjustment from Approximately 1ft to 7ft from the ground. Interchangeable circumference sections provide further options depending on application needs.

Available in 6ft and 8ft diameter, the Slingco Bull Wheel can also be produced at different sizes to suit your application.

The 6ft and the 8ft wheels are designed to withstand an imposed load of 8,000lb (SWL) with a factor of safety (FOS) of 3.

## SWIVEL TESTER



Evaluates new swivels and checks the integrity of existing swivels during their operational life.

Unlike many tools used in electrical transmission work, it's difficult to see the wear and tear that occurs inside a line swivel. The ability to perform testing on a batch of swivels that have been used previously allows you to proof load them prior to use.

- Simulates working load operational conditions
- Tests swivels up to 15,000 kg load
- Accurate to +/- 1%
- Simple to operate

## CONNECTORS: 90°, ROPE TO ROPE, ROPE TO SWIVEL

Use to connect rope, swivels and other objects. With high strength pins and smooth rollers you can safely connect rope without fear of fraying or damage. Use the convenient 90° connectors to link wire and other non-rope items. Connectors have high strength hex pins. The Rope to Rope connector has two rollers to protect rope from becoming frayed.

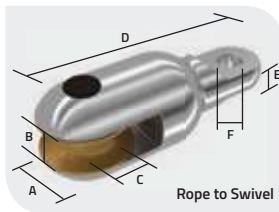
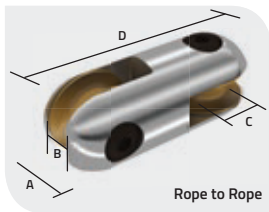
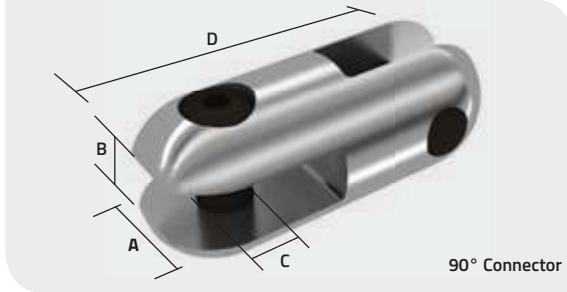

### 90° Connector

Slingco part no.	Safe working load lb (kg)	A in (mm)	B in (mm)	C in (mm)	D in (mm)	Weight lb (kg)
ZSW6554	2,500 (1,134)	7/8 (22)	3/8 (9.6)	5/16 (8)	2 1/8 (54.0)	0.17 (0.08)
ZSW6555	5,000 (2,240)	1 1/4 (31.8)	17/32 (13.5)	13/32 (10)	2 7/8 (73.0)	0.46 (0.21)
ZSW6556	9,000 (4,030)	1 1/2 (38.1)	19/32 (15)	1/2 (12.5)	3 3/8 (86)	0.73 (0.33)
ZSW6557	15,000 (6,800)	2 (50.8)	25/32 (20)	11/16 (18.0)	4 9/16 (116)	2.00 (0.91)

### Rope to Rope Connector

Slingco part no.	Safe working load lb (kg)	Max rope dia. in (mm)	A in (mm)	B in (mm)	C in (mm)	D in (mm)	Weight lb (kg)
ZSW6558	15,000 (6,800)	7/8 (22.2)	2 (50.8)	15/16 (24)	11/16 (18)	5 1/2 (140)	2.70 (1.23)

### Rope to Swivel Connector

Slingco part no.	Safe working load lb (kg)	Max rope dia. in (mm)	A in (mm)	B in (mm)	C in (mm)	D in (mm)	E in (mm)	F in (mm)	Weight lb (kg)
ZSW6559	7,000 (3,170)	7/8 (22.2)	2 (50.8)	15/16 (24)	11/16 (18)	5 5/16 (135)	1/2 (12.7)	17/32 (13.5)	2.70 (1.23)
ZSW6560	15,000 (6,800)	7/8 (22.2)	2 (50.8)	15/16 (24)	11/16 (18)	5 3/8 (137)	21/32 (16.7)	3/8 (18)	2.00 (0.91)

Safe working load based upon 3:1 factor of safety.

## CABLE LAYING ROLLER



They are of steel construction with zinc plating for general purpose cable installation work in trenches. They are suitable for power, telecoms and utility installations, and can bridge existing cables in trenches or ducts.

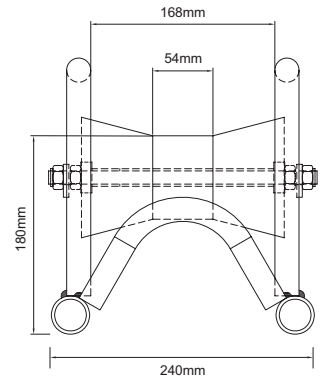

Slingco part no.	Base footprint in (mm)	Height to the top of the roller in (mm)	Handle height in (mm)
ZGP2395	12 x 9 1/2 (305 x 240)	7 1/8 (180)	10 (255)

## FEED TUBE



Due to the tight construction of the cable grip, we recommend using the Slingco Feed Tube when inserting cable or rope into the A Type Cable grips. For ease of use, our feed tubes are colour-coded to match the A Type Cable grip.

Slingco part no.	Tube to fit rope diameter in (mm)	Feed tube length in (mm)	Matches Slingco Cable Grip part no.	Cable grip colour
FTU1890	0.25 - 0.65 (6 - 16)	28 (713)	ZCS1799	Black
FTU1891	0.50 - 0.90 (13 - 23)	40 (1,018)	ZCS1800	Dark green
FTU1892	0.75 - 1.10 (19 - 28)	52 (1,324)	ZCS1801	Red
FTU1893	1.00 - 1.50 (25 - 38)	67 (1,706)	ZCS1802	Dark blue
FTU1894	1.25 - 1.70 (32 - 43)	83 (2,113)	ZCS1803	Yellow
FTU1895	1.50 - 2.10 (38 - 53)	96 (2,444)	ZCS1804	Aluminium

## CABLE SUPPORT PRODUCTS

We produce support grips for a range of applications, including vertical and horizontal support of cables/pipes and specialist applications such as wind turbines and conduit risers.

- Precise, hand-woven construction
- Specifications to suit all requirements
- Choice of one or two supporting 'eyes'
- Lace up and rod closing options

### WIND TURBINE SUPPORT GRIP - HEAVY DUTY THIMBLE OFFSET EYE



Slingco has developed a range of cable grips tailored for the renewable energy sector for use in:

- Cable installation – on-shore and off-shore
- Cable support inside wind turbines
- Cable management

For wind turbines, special features have been adapted to allow for minimal contact with the actual cable while still allowing excellent working loads and cable support.

The Slingco Wind Turbine Support Grip is manufactured from 316 Stainless Steel and provides cable support and control inside the wind turbine. It features rounded copper ferrules and offers reduced cable contact for high vibration environments. Custom grips can be adapted to meet any requirement.

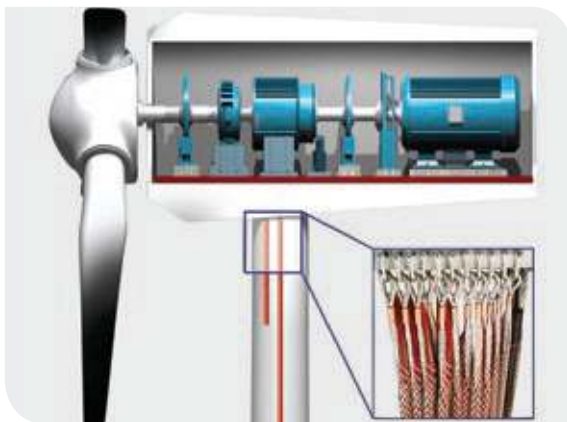

Slingco Part No	Range		Lattice Length		Approx. Break Load	
	in	mm	in	mm	lb	kg
ZCS2844	0.31 - 0.40	8 - 10	25	635	1,485	670
ZCS2845	0.40 - 0.60	10 - 15	26	660	2,295	1,040
ZCS2846	0.60 - 0.80	15 - 20	28	711	2,900	1,315
ZCS2847	0.80 - 0.99	20 - 25	29	736	4,550	2,080
ZCS2848	1.0 - 1.19	25 - 30	29	736	5,450	2,475
ZCS2849	1.20 - 1.58	30 - 40	31	787	7,800	3,575
ZCS2850	1.58 - 1.98	40 - 50	39	990	10,750	4,890
ZCS2851	1.98 - 2.37	50 - 60	39	990	10,750	4,890
ZCS2852	2.38 - 2.77	60 - 70	47	1194	14,000	6,420
ZCS2853	2.77 - 3.55	70 - 90	47	1194	14,000	6,420
ZCS2854	3.55 - 4.33	90 - 110	47	1194	18,000	8,165

### EXTENDED THIMBLE EYE HEAVY DUTY DOUBLE WEAVE STAINLESS STEEL CABLE GRIP



Slingco Part No	Range		Lattice Length		Eye Extension Length		Approx. Break Load	
	in	mm	in	mm	in	mm	lb	kg
ZCS2870	0.39 - 0.60	10 - 15	20	500	20	350	2,295	1,040
ZCS2871	0.60 - 0.80	15 - 20	20	500	20	350	2,903	1,315
ZCS2872	0.80 - 0.99	20 - 25	20	500	20	350	4,590	2,082
ZCS2873	1.0 - 1.19	25 - 30	20	500	20	350	5,468	2,480
ZCS2874	1.20 - 1.58	30 - 40	20	500	20	350	7,898	3,582

# CABLE SUPPORT GRIPS

## SINGLE EYE CLOSED MESH CABLE SUPPORT GRIP

Slingco closed mesh support grip in 304 Stainless Steel. Closed mesh for when end of cable is available.



Slingco Part No	Range		Lattice Length		Approx. Break Load	
	in	mm	in	mm	lb	kg
ZCS1893	0.50 - 0.63	12 - 16	9.7	247	567	255
ZCS1894	0.63 - 0.75	16 - 19	9.7	247	890	400
ZCS1895	0.75 - 1.00	19 - 25	13	331	1,040	470
ZCS1896	1.00 - 1.25	25 - 31	13.5	344	1,700	770
ZCS1897	1.25 - 1.50	31 - 38	15	382	1,700	770
ZCS1898	1.50 - 1.75	38 - 44	16.5	420	1,700	770
ZCS1899	1.75 - 2.00	44 - 50	20	509	2,300	1,040
ZCS1900	2.00 - 2.50	50 - 63	21	535	3,400	1,540
ZCS1901	2.50 - 3.00	63 - 76	24	611	3,400	1,540
ZCS1902	3.00 - 3.50	76 - 89	26	662	5,000	2,265
ZCS1903	3.50 - 4.00	89 - 102	29	738	5,000	2,265
ZCS5032	3.50 - 4.50	89 - 114	46	1,168	5,000	2,265

## SINGLE EYE SPLIT MESH LACE CLOSING CABLE SUPPORT GRIP

In 304 stainless steel. Split mesh is for when end of cable is not available.



Slingco Part No	Range		Lattice Length		Approx. Break Load	
	in	mm	in	mm	lb	kg
ZCS1904	0.50 - 0.63	12 - 16	9.7	247	567	255
ZCS1905	0.63 - 0.75	16 - 19	9.7	247	890	400
ZCS1906	0.75 - 1.00	19 - 25	13	331	1,040	470
ZCS1907	1.00 - 1.25	25 - 31	13.5	344	1,700	770
ZCS1908	1.25 - 1.50	31 - 38	15	382	1,700	770
ZCS1909	1.50 - 1.75	38 - 44	16.5	420	1,700	770
ZCS1910	1.75 - 2.00	44 - 50	20	509	2,300	1,040
ZCS1911	2.00 - 2.50	50 - 63	21	535	3,400	1,540
ZCS1912	2.50 - 3.00	63 - 76	24	611	3,400	1,540
ZCS1913	3.00 - 3.50	76 - 89	26	662	5,000	2,265
ZCS1914	3.50 - 4.00	89 - 102	29	738	5,000	2,265

## SINGLE EYE SPLIT MESH ROD CLOSING CABLE SUPPORT GRIP

Similar to the lace up grip, in 304 Stainless Steel, but in this design it is closed by inserting a metal rod down the length of the grip. For when end of cable is not available.



Slingco Part No	Range		Lattice Length		Approx. Break Load	
	in	mm	in	mm	lb	kg
ZCS2362	0.50 - 0.63	12 - 16	9.7	247	567	255
ZCS2363	0.63 - 0.75	16 - 19	9.7	247	890	400
ZCS2162	0.75 - 1.00	19 - 25	13	331	1,040	470
ZCS2163	1.00 - 1.25	25 - 31	13.5	344	1,700	770
ZCS2164	1.25 - 1.50	31 - 38	15	382	1,700	770
ZCS2165	1.50 - 1.75	38 - 44	16.5	420	1,700	770
ZCS2166	1.75 - 2.00	44 - 50	20	509	2,300	1,040
ZCS2167	2.00 - 2.50	50 - 63	21	535	3,400	1,540
ZCS2168	2.50 - 3.00	63 - 76	24	611	3,400	1,540
ZCS2169	3.00 - 3.50	76 - 89	26	662	5,000	2,265
ZCS2372	3.50 - 4.00	89 - 102	29	738	5,000	2,265



## DOUBLE EYE CLOSED MESH CABLE SUPPORT GRIP

Double eye closed mesh support grip in 304 stainless steel. Two eyes for two connect/support points. Closed mesh for when end of cable is available.



Slingco Part No	Range		Lattice Length		Approx. Break Load	
	in	mm	in	mm	lb	kg
ZCS2038	0.50 - 0.63	12 - 16	9.7	247	512	230
ZCS2039	0.63 - 0.75	16 - 19	9.7	247	740	335
ZCS2040	0.75 - 1.00	19 - 25	13	331	1,000	450
ZCS2041	1.00 - 1.25	25 - 31	15	344	1,540	695
ZCS2042	1.25 - 1.50	31 - 38	16.5	382	1,540	695
ZCS2043	1.50 - 1.75	38 - 44	20	420	2,010	910
ZCS2044	1.75 - 2.00	44 - 50	21	509	3,230	1,465
ZCS2045	2.00 - 2.50	50 - 63	24	535	3,230	1,465
ZCS2046	2.50 - 3.00	63 - 76	26	611	4,000	1,815
ZCS2047	3.00 - 3.50	76 - 89	29	662	4,000	1,815
ZCS2048	3.50 - 4.00	89 - 102	29	738	4,001	1,815
ZCS6404	4.00 - 4.50	102 - 114	30	762	4,000	1,815
ZCS6405	4.50 - 5.00	114 - 127	30	762	4,000	1,815
ZCS6406	5.00 - 5.50	127 - 140	30	762	4,000	1,815

## DOUBLE EYE SPLIT MESH LACE CLOSING CABLE SUPPORT GRIP

Double eye split mesh lace closing, in 304 Stainless Steel, for secure attachment and support where the cable end is not accessible.



Slingco Part No	Range		Lattice Length		Approx. Break Load	
	in	mm	in	mm	lb	kg
ZCS2998	0.50 - 0.63	12 - 16	10	254	530	240
ZCS2999	0.63 - 0.75	16 - 19	10	254	790	360
ZCS3000	0.75 - 1.00	19 - 25	13	330	1,020	460
ZCS3001	1.00 - 1.25	25 - 31	14	355	1,610	730
ZCS3002	1.25 - 1.50	31 - 38	15	381	1,610	730
ZCS3003	1.50 - 1.75	38 - 44	17	432	1,610	730
ZCS3004	1.75 - 2.00	44 - 50	19	482	2,150	975
ZCS3005	2.00 - 2.50	50 - 63	21	533	3,260	1,480
ZCS3006	2.50 - 3.00	63 - 76	23	584	3,260	1,480
ZCS3007	3.00 - 3.50	76 - 89	25	635	4,900	2,222
ZCS3008	3.50 - 4.00	89 - 102	27	685	4,900	2,222

## DOUBLE EYE SPLIT MESH ROD CLOSING CABLE SUPPORT GRIP

Double eye split mesh rod closing, in 304 Stainless Steel, for secure attachment and support where the cable end is not accessible.



Slingco Part No	Range		Lattice Length		Approx. Break Load	
	in	mm	in	mm	lb	kg
ZCS3009	0.50 - 0.63	12 - 16	8.5	216	790	355
ZCS3010	0.63 - 0.75	16 - 19	8.5	216	790	355
ZCS3011	0.75 - 1.00	19 - 25	10.5	266	1,020	460
ZCS3012	1.00 - 1.25	25 - 31	12.5	317	1,610	730
ZCS3013	1.25 - 1.50	31 - 38	14.5	368	1,610	730
ZCS3014	1.50 - 1.75	38 - 44	15.5	394	1,610	730
ZCS3015	1.75 - 2.00	44 - 50	16.5	419	2,150	975
ZCS3016	2.00 - 2.50	50 - 63	19.5	495	3,260	1,475
ZCS3017	2.50 - 3.00	63 - 76	21.5	546	3,260	1,475
ZCS3018	3.00 - 3.50	76 - 89	23.5	597	5,750	2,600
ZCS3019	3.50 - 4.00	89 - 102	25.5	648	5,750	2,600

# CABLE SUPPORT GRIPS

## OFFSET EYE CLOSED MESH CABLE SUPPORT GRIP

The offset eye grip is designed to support the cable weight as it hangs vertically or horizontally. Closed mesh for when end of cable is available.



Slingco Part No	Range		Lattice Length		Approx. Break Load	
	in	mm	in	mm	lb	kg
ZCS1915	0.50 - 0.63	12 - 16	9.7	247	512	230
ZCS1916	0.63 - 0.75	16 - 19	9.7	247	740	335
ZCS1917	0.75 - 1.00	19 - 25	13	331	1,000	450
ZCS1918	1.00 - 1.25	25 - 31	13.5	344	1,540	695
ZCS1919	1.25 - 1.50	31 - 38	15	382	1,540	695
ZCS1920	1.50 - 1.75	38 - 44	16.5	420	1,540	910
ZCS1921	1.75 - 2.00	44 - 50	20	509	2,010	1,465
ZCS1922	2.00 - 2.50	50 - 63	21	535	3,230	1,465
ZCS1923	2.50 - 3.00	63 - 76	24	611	3,230	1,815
ZCS1924	3.00 - 3.50	76 - 89	26	662	4,000	1,815
ZCS1925	3.50 - 4.00	89 - 102	29	738	4,000	1,815
ZCS6408	4.00 - 4.50	102 - 114	28	711	4,000	1,815
ZCS6409	4.50 - 5.00	114 - 127	28	711	4,000	1,815
ZCS6410	5.00 - 5.50	127 - 140	28	711	4,000	1,815

## OFFSET EYE SPLIT MESH LACE CLOSING CABLE SUPPORT GRIP

This grip, in 304 Stainless Steel, is ideal for several support points along the same cable when the cable ends are not accessible.



Slingco Part No	Range		Lattice Length		Approx. Break Load	
	in	mm	in	mm	lb	kg
ZCS1926	0.50 - 0.63	12 - 16	10	254	500	225
ZCS1927	0.63 - 0.75	16 - 19	10	254	750	340
ZCS1928	0.75 - 1.00	19 - 25	13	330	950	430
ZCS1929	1.00 - 1.25	25 - 31	14	355	1,500	680
ZCS1930	1.25 - 1.50	31 - 38	15	381	1,500	680
ZCS1931	1.50 - 1.75	38 - 44	17	432	1,500	680
ZCS1932	1.75 - 2.00	44 - 50	19	482	2,000	905
ZCS1933	2.00 - 2.50	50 - 63	21	533	2,150	975
ZCS1934	2.50 - 3.00	63 - 76	23	584	2,150	975
ZCS1935	3.00 - 3.50	76 - 89	25	635	3,800	1,720
ZCS1936	3.50 - 4.00	89 - 102	27	685	3,800	1,720

## OFFSET EYE SPLIT MESH ROD CLOSING CABLE SUPPORT GRIP

Ideal for several support points along the same cable when the cable ends are not accessible. Made from 304 Stainless Steel.



Slingco Part No	Range		Lattice Length		Approx. Break Load	
	in	mm	in	mm	lb	kg
ZCS3031	0.50 - 0.63	12 - 16	7	178	500	225
ZCS3032	0.63 - 0.75	16 - 19	9	229	750	340
ZCS3033	0.75 - 1.00	19 - 25	10	254	950	430
ZCS3034	1.00 - 1.25	25 - 31	12	305	1,500	680
ZCS3035	1.25 - 1.50	31 - 38	14	359	1,500	680
ZCS3036	1.50 - 1.75	38 - 44	15	381	1,500	680
ZCS3037	1.75 - 2.00	44 - 50	16	406	2,000	905
ZCS3038	2.00 - 2.50	50 - 63	19	483	3,100	975
ZCS3039	2.50 - 3.00	63 - 76	20	508	3,100	975
ZCS3040	3.00 - 3.50	76 - 89	21	533	4,300	1,720
ZCS3041	3.50 - 4.00	89 - 102	21	533	4,900	1,720

**UNIVERSAL EYE CLOSED MESH CABLE SUPPORT GRIP**

Fitted with an adjustable eye for easy and secure attachment, where the end of the cable can be inserted in to the support grip. Made from 304 Stainless Steel.



Slingco Part No	Range		Lattice Length		Approx. Break Load	
	in	mm	in	mm	lb	kg
ZCS2664	0.50 - 0.63	12 - 16	10	254	530	240
ZCS2665	0.63 - .0.75	16 - 19	10	254	790	360
ZCS2666	0.75 - 1.00	19 - 25	13	330	1,020	460
ZCS2667	1.00 - 1.25	25 - 31	14	355	1,610	730
ZCS2324	1.25 - 1.50	31 - 38	15	381	1,610	730
ZCS2668	1.50 - 1.75	38 - 44	17	432	1,610	730
ZCS2669	1.75 - 2.00	44 - 50	19	483	2,150	975
ZCS2670	2.00 - 2.50	50 - 63	21	533	3,260	1,480
ZCS2671	2.50 - 3.00	63 - 76	23	584	3,260	1,480

**UNIVERSAL EYE SPLIT MESH LACE CLOSING CABLE SUPPORT GRIP**

Fitted with an adjustable eye for easy and secure attachment, where the end of the cable is not accessible. Made from 304 Stainless Steel.



Slingco Part No	Range		Lattice Length		Approx. Break Load	
	in	mm	in	mm	lb	kg
ZCS2672	0.50 - 0.63	12 - 16	10	254	530	240
ZCS2673	0.63 - .0.75	16 - 19	10	254	790	360
ZCS2674	0.75 - 1.00	19 - 25	13	330	1,020	460
ZCS2675	1.00 - 1.25	25 - 31	14	355	1,610	730
ZCS2676	1.25 - 1.50	31 - 38	15	381	1,610	730
ZCS2677	1.50 - 1.75	38 - 44	17	432	1,610	730
ZCS2678	1.75 - 2.00	44 - 50	19	483	2,150	975
ZCS2679	2.00 - 2.50	50 - 63	21	533	3,260	1,480
ZCS2680	2.50 - 3.00	63 - 76	23	584	3,280	1,480
ZCS2681	3.00 - 3.50	76 - 89	25	635	4,900	2,222
ZCS2682	3.50 - 4.00	89 - 102	27	686	4,900	2,222

**UNIVERSAL EYE SPLIT MESH ROD CLOSING CABLE SUPPORT GRIP**

Fitted with an adjustable eye for easy and secure attachment, where the end of the cable is not accessible. Made from 304 Stainless Steel.



Slingco Part No	Range		Lattice Length		Approx. Break Load	
	in	mm	in	mm	lbs	kg
ZCS2683	0.50 - 0.63	12 - 16	8.5	216	530	240
ZCS2684	0.63 - .0.75	16 - 19	8.5	216	790	360
ZCS2685	0.75 - 1.00	19 - 25	10.5	267	1,020	460
ZCS2686	1.00 - 1.25	25 - 31	12.5	317	1,610	730
ZCS2687	1.25 - 1.50	31 - 38	14.5	368	1,610	730
ZCS2688	1.50 - 1.75	38 - 44	15.5	394	1,610	730

**CAN'T FIND THE SPECIFICATION YOU NEED?**

Call or email for full ranges plus custom manufacture options

**01706 855558**

sales@slingco.com

# CABLE SUPPORT GRIPS

## CONDUIT RISER CABLE GRIP - STAINLESS STEEL



A single weave grip, with a support ring, designed for the support of electrical cabling in standard rigid conduit.

Slingco comparison reference numbers and Approximate breaking strengths (lbs)

Conduit size inches	Cable sizes diameter inches																
	0.50-0.63	0.63-0.75	0.75-1.00	1.00-1.25	1.25-1.50	1.50-1.75	1.75-2.00	2.0-2.5	2.0-3.0	2.5-3.0	3.5-4.0	3.0-3.5	3.5-4.5	3.5-4.0	4.0-4.5	4.5-5.0	4.5-5.0
	Length inches																
	8	9	11	12	12	14	15	17	17	18	18	20	20	21	21	27	27
0.75	ZCS2690 530																
1	ZCS2691 490	ZCS2694 790															
1.25	ZCS2692 450	ZCS2695 740	ZCS2698 1,030														
1.5		ZCS2696 690	ZCS2699 970	ZCS2701 1,610													
2	ZCS2693 370	ZCS2697 640	ZCS2700 920	ZCS2702 1,520	ZCS2704 1,610												
2.5					ZCS2705 1,510	ZCS2707 1,610	ZCS2708 2,150										
3				ZCS2703 1,340	ZCS2706 1,400	ZCS2709 1,490	ZCS2710 1,990	ZCS2711 3,260									
3.5								ZCS2714 2,970		ZCS2716 3,260							
4							ZCS2712 1,670	ZCS2713 2,680		ZCS2715 2,890		ZCS2717 4,080					
5									ZCS5645* 2,150	ZCS2719 2,150	ZCS5646* 3,130	ZCS2721 2,860		ZCS2723 3,130			
6												ZCS2722 2,240	ZCS5647 2,240	ZCS2724 2,240	ZCS4755 2,240	ZCS3259 4,995	ZCS4284 4,995

## HOOKED EYE CONDUIT SUPPORT CABLE SUPPORT GRIP

Heavy duty stainless steel grip for outdoor riser pole applications.



Slingco Part No	Range		Lattice Weave	Lattice Length		Approx. Break Load	
	in	mm		in	mm	lb	kg
ZCS5430	2.25 - 2.75	57 - 70	Double	21	533	2,000	910
ZCS5268	3.25 - 3.75	82 - 95	Double	21	533	6,500	2,902
ZCS5062	3.50 - 4.25	89 - 108	Double	21	533	6,500	2,902
ZCS4301	4.0 - 4.50	102 - 114	Double	21	533	6,000	2,678

**STAINLESS STEEL CONNECTOR/BOX GRIP**

Dual Weave – these grips are designed with a ring to support electric cabling from termination point to reduce strain on the connections. 304 stainless steel.

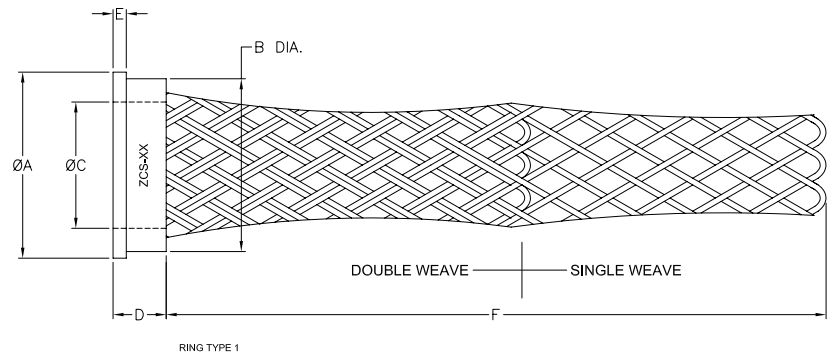

Slingco part no.	Cable dia min inches (mm)	Cable dia max inches (mm)	Ø A inches (mm)	B inches (mm)	Ø C inches (mm)	D inches (mm)	E inches (mm)	F inches (mm)	Approx. breaking strength lb (kg)
ZCS2208	0.2 (5.1)	0.25 (6.4)	1.25 (31.8)	1.12 (28.4)	0.31 (7.9)	0.281 (7.1)	0.125 (3.2)	3 (76)	500 (225)
ZCS2209	0.31 (7.9)	0.375 (9.5)	1.25 (31.8)	1.12 (28.4)	0.437 (11.1)	0.281 (7.1)	0.125 (3.2)	4 (102)	750 (340)
ZCS2210	0.41 (10.4)	0.5 (12.7)	1.25 (31.8)	1.12 (28.4)	0.562 (14.3)	0.281 (7.1)	0.125 (3.2)	5 (127)	750 (340)
ZCS2211	0.5 (12.7)	0.625 (15.9)	1.25 (31.8)	1.12 (28.4)	0.687 (17.4)	0.281 (7.1)	0.125 (3.2)	6 (152)	1,200 (540)
ZCS2212	0.61 (15.5)	0.75 (19.1)	1.25 (31.8)	1.12 (28.4)	0.812 (20.6)	0.281 (7.1)	0.125 (3.2)	7 (178)	1,200 (540)
ZCS2213	0.71 (18.0)	0.875 (22.2)	1.25 (31.8)	1.12 (28.4)	0.937 (23.8)	0.281 (7.1)	0.125 (3.2)	7½ (178)	1,000 (450)
ZCS2214	0.77 (19.6)	0.937 (23.8)	1.25 (31.8)	1.12 (28.4)	0.948 (24.1)	0.219 (5.6)	-	8 (203)	800 (360)
ZCS2215	0.31 (7.9)	0.375 (9.5)	1.75 (44.5)	1.62 (41.1)	0.437 (11.1)	0.281 (7.1)	0.125 (3.2)	4 (102)	500 (225)
ZCS2216	0.41 (10.4)	0.5 (12.7)	1.75 (44.5)	1.62 (41.1)	0.562 (14.3)	0.281 (7.1)	0.125 (3.2)	5 (127)	750 (340)
ZCS2217	0.5 (12.7)	0.625 (15.9)	1.75 (44.5)	1.62 (41.1)	0.687 (17.4)	0.281 (7.1)	0.125 (3.2)	6 (152)	1,000 (450)
ZCS2218	0.61 (15.5)	0.75 (19.1)	1.75 (44.5)	1.62 (41.1)	0.812 (20.6)	0.281 (7.1)	0.125 (3.2)	7 (178)	1,000 (450)
ZCS2219	0.71 (18.0)	0.875 (22.2)	1.75 (44.5)	1.62 (41.1)	0.937 (23.8)	0.281 (7.1)	0.125 (3.2)	7½ (190)	1,000 (450)
ZCS2220	0.82 (20.8)	1 (25.4)	1.75 (44.5)	1.62 (41.1)	1.062 (27.0)	0.281 (7.1)	0.125 (3.2)	8½ (215)	1,000 (450)
ZCS2221	0.915 (23.2)	1.125 (28.6)	1.75 (44.5)	1.62 (41.1)	1.187 (30.1)	0.281 (7.1)	0.125 (3.2)	9 (229)	1,500 (680)
ZCS2222	1.02(25.9)	1.25 (31.8)	1.75 (44.5)	1.62 (41.1)	1.312 (33.3)	0.281 (7.1)	0.125 (3.2)	10 (254)	1,000 (450)
ZCS2223	1.18 (30.0)	1.437 (36.5)	1.75 (44.5)	1.62 (41.1)	1.448 (36.8)	0.219 (5.6)	-	10½ (265)	500 (225)
ZCS2224	0.5 (12.7)	0.625 (15.9)	2.25 (57.2)	2.12 (53.8)	0.687 (17.4)	0.281 (7.1)	0.125 (3.2)	6 (152)	1,000 (450)
ZCS2225	0.71 (18.0)	0.875 (22.2)	2.25 (57.2)	2.12 (53.8)	0.937 (23.8)	0.281 (7.1)	0.125 (3.2)	7½ (178)	1,000 (450)
ZCS2226	0.915 (23.2)	1.125 (28.6)	2.25 (57.2)	2.12 (53.8)	1.187 (30.1)	0.281 (7.1)	0.125 (3.2)	9 (229)	1,500 (680)
ZCS2227	1.02 (25.9)	1.25 (31.8)	2.25 (57.2)	2.12 (53.8)	1.312 (33.3)	0.281 (7.1)	0.125 (3.2)	10 (254)	1,800 (815)
ZCS2228	1.22 (31.0)	1.5 (38.1)	2.25 (57.2)	2.12 (53.8)	1.562 (39.7)	0.281 (7.1)	0.125 (3.2)	11 (279)	1,800 (815)
ZCS2229	1.43 (36.3)	1.75 (44.5)	2.25 (57.2)	2.12 (53.8)	1.812 (46.0)	0.281 (7.1)	0.125 (3.2)	13 (330)	700 (315)
ZCS2230	1.18 (30.0)	1.937 (49.2)	2.25 (57.2)	2.12 (53.8)	1.948 (49.5)	0.219 (5.6)	-	14½ (365)	350 (155)
ZCS2231	0.82 (20.8)	1 (25.4)	2.75 (69.9)	2.62 (66.5)	1.062 (27.0)	0.281 (7.1)	0.125 (3.2)	8½ (215)	1,000 (450)
ZCS2232	1.02 (25.9)	1.25 (31.8)	2.75 (69.9)	2.62 (66.5)	1.312 (33.3)	0.281 (7.1)	0.125 (3.2)	10 (254)	1,500 (680)
ZCS2233	1.22 (31.0)	1.5 (38.1)	2.75 (69.9)	2.62 (66.5)	1.562 (39.7)	0.281 (7.1)	0.125 (3.2)	11 (279)	1,500 (680)
ZCS2234	1.43 (36.3)	1.75 (44.5)	2.75 (69.9)	2.62 (66.5)	1.812 (46.0)	0.281 (7.1)	0.125 (3.2)	13 (330)	1,800 (815)
ZCS2235	1.64 (41.7)	2 (50.8)	2.75 (69.9)	2.62 (66.5)	2.062 (52.4)	0.281 (7.1)	0.125 (3.2)	15 (381)	1,800 (815)
ZCS2236	1.84 (46.7)	2.25 (57.2)	2.75 (69.9)	2.62 (66.5)	2.312 (58.7)	0.281 (7.1)	0.125 (3.2)	16 (406)	1,500 (680)
ZCS2237	2.062 (52.4)	2.469 (62.7)	2.75 (69.9)	2.62 (66.5)	2.489 (63.2)	0.219 (5.6)	-	17½ (444)	1,500 (680)
ZCS2238	1.375 (34.9)	1.75 (44.5)	3.25 (82.6)	3.12 (79.2)	1.812 (46.0)	0.281 (7.1)	0.125 (3.2)	13 (330)	2,000 (905)
ZCS2239	1.75 (44.5)	2 (50.8)	3.25 (82.6)	3.12 (79.2)	2.062 (52.4)	0.281 (7.1)	0.125 (3.2)	15 (381)	2,000 (905)
ZCS2240	1.84 (46.7)	2.25 (57.2)	3.25 (82.6)	3.12 (79.2)	2.312 (58.7)	0.281 (7.1)	0.125 (3.2)	16 (406)	2,000 (905)
ZCS2241	2.125 (54.0)	2.5 (63.5)	3.25 (82.6)	3.12 (79.2)	2.562 (65.1)	0.281 (7.1)	0.125 (3.2)	17½ (444)	2,000 (905)
ZCS2242	2.5 (63.5)	2.875 (73.0)	3.25 (82.6)	3.12 (79.2)	2.918 (74.1)	0.219 (5.6)	-	19 (483)	2,000 (905)

**CAN'T FIND THE SPECIFICATION YOU NEED?**

Call or email for full ranges plus custom manufacture options

**01706 855558**

sales@slingco.com

## CABLE PROTECTION & CEMENTING PRODUCTS

Complementing our cable pulling and support products, we also produce a growing range of specialized cable protection products, as used by the offshore oil and gas industries. All products are engineered to highest quality to ensure that they deliver the levels of safety and performance required in the most demanding applications.

- Innovative, streamlined cable protectors
- Bow spring and rigid centralisers
- Designed and engineered to highest standards
- Specialist supplier to offshore for 40+ years

- Safe, quick and efficient conveying and securing of downhole cables into well-bores
- Suitable for the protection of any size ESP cables, control lines, umbilicals and encapsulated bundles in well-bores
- Suitable for round or flat cables
- Streamlined design helps prevent hang-ups downhole
- Eliminates compression-induced damage to downhole cables
- Slip and rotation resistant design
- Each Cable Protector assembly incorporates an eight point friction pad gripping system to accommodate a wide variety of API tubes
- Corrosion-resistant for long working life
- Designed to enable re-use subject to safety checks

### STANDARD CABLE PROTECTORS



The Slingco Cable Protector has been purpose-designed for use on the wide range of cables, lines and umbilicals that have to be conveyed in and out of well-bores. Its innovative, streamlined form minimises the risk of downhole hang-ups to ensure maximum operational productivity. Each protector features an eight-point friction pad gripping system that provides a secure, reliable grip to enable the safe, quick and effective conveying and securing of ESP cables, control lines, umbilicals and encapsulated bundles.

### CENTRALISING CABLE PROTECTORS



This versatile 'hybrid' product is designed to fulfil the dual role of cable protection and centralisation, ensuring both can be achieved as quickly and efficiently as possible. As with the other cable protectors in our range, the Centralising Cable Protector is available in standard and specialized configurations.

## MID-JOINT CABLE PROTECTORS



The Mid-Joint Cable Protector is installed between joints of down-hole tubing strings, and is often used in conjunction with other cable protectors to further secure and protect cables or lines from damage.

## BANDED CABLE PROTECTORS



These lightweight, stamped steel protective cable guards offer a compact, low-cost alternative to our standard Cable Protectors. Designed for use in shallow wells with little to no deviation, the protectors are situated across the coupling and attached to the tubing string with steel bands.

Part No.	Description	Tube Ø	Cable type	Cable size
ZCP3592	Cable Protector - 2 3/8 R6	2 3/8	Round	Ø6mm
ZCP3877	Cable Protector - 2 3/8 R6-8	2 3/8	Round	Ø6-8mm
ZCP3878	Cable Protector - 2 3/8 F11/34	2 3/8	Flat	11mm Square
ZCP3601	Cable Protector - 2 3/8 R32-34	2 3/8	Round	Ø6mm
ZCP3593	Cable Protector - 2 7/8 R6	2 7/8	Round	Ø6mm
ZCP3879	Cable Protector - 2 7/8 R6-8	2 7/8	Round	Ø6-8mm
ZCP3600	Cable Protector - 2 7/8 R6 N	2 7/8	Round	Ø6mm
ZCP3880	Cable Protector - 2 7/8 F11/34	2 7/8	Flat	11mm Square
ZCP3602	Cable Protector - 2 7/8 F16-19/56	2 7/8	Flat	16-19 Square
ZCP3603	Cable Protector - 2 7/8 F16-19/70	2 7/8	Flat	16-19 Square
ZCP3604	Cable Protector - 2 7/8 F11-16/56	2 7/8	Flat	11-16 Square
ZCP3605	Cable Protector - 2 7/8 R30-33	2 7/8	Round	Ø30-33mm
ZCP3606	Cable Protector - 2 7/8 R34-37	2 7/8	Round	Ø34-37mm
ZCP3594	Cable Protector - 3 1/2 R6	3 1/2	Round	Ø6mm
ZCP3881	Cable Protector - 3 1/2 R6-8	3 1/2	Round	Ø6-8mm
ZCPY065	Cable Protector - 3 1/2 F11/34	3 1/2	Flat	11mm Square
ZCP3607	Cable Protector - 3 1/2 F16-19/60	3 1/2	Flat	16-19 Square
ZCP3974	Cable Protector - 3 1/2 F16-19/70	3 1/2	Flat	16-19 Square
ZCP3977	Cable Protector - 3 1/2 F11-16/60	3 1/2	Flat	11-16 Square
ZCP3980	Cable Protector - 3 1/2 F19-23/60	3 1/2	Flat	19-23 Square
ZCP3983	Cable Protector - 3 1/2 R30-33	3 1/2	Round	Ø30-33mm
ZCP3986	Cable Protector - 3 1/2 R34-37	3 1/2	Round	Ø34-37mm
ZCP3989	Cable Protector - 3 1/2 R38-42	3 1/2	Round	Ø38-42mm
ZCP3596	Cable Protector - 4 1/2 R6	4 1/2	Round	Ø6mm
ZCP3882	Cable Protector - 4 1/2 R6-8	4 1/2	Round	Ø6-8mm
ZCP3883	Cable Protector - 4 1/2 F11/34	4 1/2	Flat	11mm Square
ZCP4015	Cable Protector - 4 1/2 F16-19/60	4 1/2	Flat	16-19 Square
ZCP4016	Cable Protector - 4 1/2 F11-16/56	4 1/2	Flat	11-16 Square
ZCP4017	Cable Protector - 4 1/2 F19-23/60	4 1/2	Flat	19-23 Square
ZCP4018	Cable Protector - 4 1/2 R34-37	4 1/2	Round	Ø34-37mm
ZCP4019	Cable Protector - 4 1/2 R38-42	4 1/2	Round	Ø38-42mm
ZCP3598	Cable Protector - 5 1/2 R6	5 1/2	Round	Ø6mm
ZCP3884	Cable Protector - 5 1/2 R6-8	5 1/2	Round	Ø6-8mm
ZCP3885	Cable Protector - 5 1/2 F11/34	5 1/2	Flat	11mm Square
ZCP4020	Cable Protector - 5 1/2 F16-19/70 Dual	5 1/2	Flat	16-19 Square
ZCP4021	Cable Protector - 5 1/2 F11-16/56	5 1/2	Flat	11-16 Square
ZCP4022	Cable Protector - 5 1/2 R34-37	5 1/2	Round	Ø34-37mm
ZCP3599	Cable Protector - 7 R6	7	Round	Ø6mm
ZCP3886	Cable Protector - 7 R6-8	7	Round	Ø6-8mm
ZCP3887	Cable Protector - 7 F11/34	7	Flat	11mm Square

**CAN'T FIND THE SPECIFICATION YOU NEED?**

Call or email for full ranges plus custom manufacture options

**01706 855558**

sales@slingco.com

# CENTRALISERS

## BOW SPRING CENTRALISERS

Specially designed for vertical wells where low principal forces and high restoring forces are required, this one-piece design simplifies installation onto casings. The Bow Spring Centraliser is available in multiple sizes and blade configurations.

### Standard Bow Spring Centraliser



### High Performance Bow Spring Centraliser



Slingco part no.	Specification
ZCW4481	4.50" x OD 5.875"
ZCW4482	4.50" x OD 6.00"
ZCW4483	4.50" x OD 8.50"
ZCW4484	5.50" x OD 8.50"
ZCW4485	5.50" x OD 9.50"
ZCW4486	7.00" x OD 9.50"
ZCW4487	7.00" x OD 10.50"
ZCW4488	9.625" x OD 12.50"
ZCW4489	9.625" x OD 14.50"
ZCW4490	10.00" x OD 14.50"
ZCW4491	10.00" x OD 15.50"
ZCW4492	13.375" x OD 18.50"
ZCW4493	13.625" x OD 18.50"
ZCW4494	16.00" x OD 21.00"
ZCW4495	20.00" x OD 26.00"

**DESIGNED TO DELIVER RELIABLE CENTRALISING AND SPACING OF PIPING WITHIN LARGER DIAMETER PIPES**

**AVAILABLE IN BOW SPRING AND RIGID OPTIONS**

## RIGID CENTRALISERS

Designed to ensure concentricity and standoff in deviated and horizontal wells, this one-piece Centraliser minimises differential sticking. As with other Centralisers in our range the Rigid Centraliser is available in multiple sizes and blade configurations.

### One Piece Rigid Centraliser

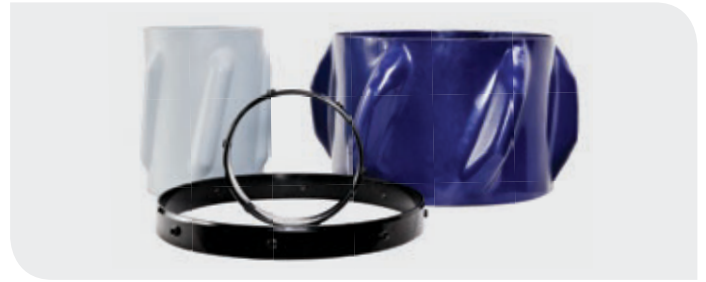

### Welded Rigid Centraliser



Slingco part no.	Specification	OD	Height	Blade Type	Blade Quantity
ZCW4496	2.875" x 6.125"	5.8125"	5"	Straight	4
ZCW4497	3.5" x 6.125"	5.8125"	5"	Straight	4
ZCW4498	3.5" x 8.5"	8.25"	8"	Straight	4
ZCW4499	4.5" x 6"	5.75"	10"	Spiral	4
ZCW4561	4.5" x 5.875"	5.625"	10"	Spiral	4
ZCW4562	4.5" x 8.5"	8.25"	10"	Straight	4
ZCW4563	5" x 6"	5.75"	10"	Spiral	4
ZCW4564	5.5" x 8.5"	8.25"	10"	Spiral	4
ZCW4565	6.625" x 8.5"	8.25"	10"	Spiral	4
ZCW4566	7" x 8.5"	8.25"	6.5"	Straight	5
ZCW4567	7" x 8.5"	8.25"	7"	Straight	5
ZCW4568	7" x 8.5"	8.25"	10"	Spiral	5
ZCW4568	7" x 8.375"	8.125"	10"	Spiral	5
ZCW4569	7" x 10.625"	10.375"	10"	Spiral	5
ZCW4570	7" x 12.25"	10.625"	10"	Spiral	5
ZCW4571	7" x 12.25"	12"	10"	Spiral	5
ZCW4572	7" x 8.5"	8.25"	7"	Straight	4
ZCW4573	9.625" x 12.25"	11.875"	6.5"	Straight	5
ZCW4574	9.625" x 12.25"	11.875"	6.5"	Spiral	5
ZCW4575	9.625" x 12.25"	12"	10"	Spiral	5
ZCW4576	9.625" x 12.25"	12"	6.75"	Spiral	5
ZCW4577	11.75" x 13.5"	13.25"	10"	Spiral	6
ZCW4578	13.375" x 16"	15.5"	10"	Spiral	6
ZCW4579	13.375" x 16"	15.5"	10"	Straight	6
ZCW4580	13.375" x 16"	15.75"	10"	Spiral	6
ZCW4581	13.375" x 17.5"	17"	10"	Spiral	6
ZCW4582	13.375" x 17.5"	17"	10"	Straight	6
ZCW4583	13.375" x 17.5"	17.25"	10"	Spiral	6
ZCW4584	13.625" x 17.5"	16"	10"	Spiral	6
ZCW4585	18.625" x 27"	26"	10"	Straight	6



## CABLE PULLING GRIPS AND CABLE SUPPORT GRIPS

### ASSESSMENT OF SUITABILITY

There are many factors that must be taken into account when assessing the suitability of a cable grip for a proposed application and trying to calculate a safe working load. These include:

- Size of cable grip in relation to size/ shape of gripped object(s)
- Stability of object(s) when gripped
- Grip surface of object(s)
- Resistive force of object(s)
- Anticipated path of movement, including possible obstructions
- Approximate breaking strength of the cable grip
- Condition of cable grip
- Suitability and compatibility of any attachments used
- Environment / operating conditions
- Persons at risk

If you have any questions regarding suitability for any particular application please call the distributor who supplied the cable grip or our in-house Technical Department.

*Please note:* Slingco cable grips must be double steel banded securely before being pulled.

### LATTICE DIMENSIONS

Lattice dimensions shown are as fitted to a nominal diameter of cable and prior 'free length' may be slightly longer than stated.

### APPROXIMATE BREAK LOAD

This is the calculated average based on actual testing done by Slingco. Approximate break loads are quoted as a guide only.

### SAFE WORKING LOAD

Application load is normally calculated to be reduced by at least a factor of 5x the Approximate break load. Due to the wide variety of application parameters, the end user must apply a sensible safety factor to suit the safety requirements for the conditions of use.

The Safe Working Load (SWL) of a Slingco cable grip will depend on the Factor of Safety (FOS) applied to the Minimum Breaking Load.

### FACTOR OF SAFETY (FOS)

Where the operational risk is considered to be normal, it is recommended that a FOS of 5 be applied, for a high risk operation a FOS of at least 10 should be considered. It is impossible to catalogue or guarantee a safety factor that will apply for all applications.

Approximate Break Loads stated on any certification, the recommended Factors of Safety, and any implied or stated fitness for purpose, are all only applicable when the cable grip is as new and unused.

A 20% variance in break loads must be allowed for when selecting a cable grip; a suitable swivel must be used if there is 'twist' in the cable.

Torsional stress must be dealt with when using grips for line pulls and wire splices. When twisting forces are present use a swivel that rotates under load to release torsional stress.

## Cable Grip Safety Information

- Ensure that the cable grip mesh fits conductor correctly
  - Ensure that the conductor fits up to the mid-point of the protective shoulder
  - Clamp the ends of the cable grip when attaching the conductor. We recommend between 1¼" and 2¼" from the end of the cable grips
- SECURE CLAMPING MUST BE USED ON SLINGCO CABLE GRIPS**
- Never modify or attempt to repair any grip
  - Ensure proper maintenance of the cable grip. If in doubt call 888-685-9478
  - Check the condition of the cable grip, and that it is the correct size for the intended application - do not exceed the rated capacity
  - Grips that are worn, bent or otherwise damaged should not be used
  - Grips are only to be used for temporary installations
  - Pulling devices should only be attached via the pulling eye
  - Cable grips must only be fitted and used by trained competent person(s)



**SLINGCO CABLE GRIPS MUST NOT BE USED TO THEIR APPROXIMATE BREAKING STRENGTH. A SENSIBLE SAFETY FACTOR MUST ALWAYS BE USED. IF IN DOUBT CONTACT THE MANUFACTURER OR THE DISTRIBUTOR THAT SUPPLIED THE GRIP!**

**If you have any questions regarding suitability for any particular application please call 888-685-9478**

### TYPICAL CONFIGURATIONS

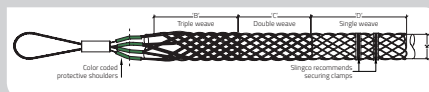
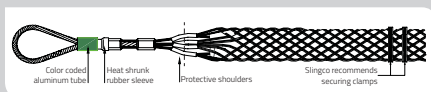

# IMPORTANT TECHNICAL INFORMATION

## SINGLE AND DOUBLE EYE CABLE GRIP INSTRUCTIONS

**PLEASE NOTE:** The condition of the cable grip should always be checked prior to use. The correct size of grip should always be used for the intended application. The rated capacity of the grip should never be exceeded. Grips that are worn, bent or otherwise damaged should not be used.



1 Select the correct grip for the diameter of the conductor.



2 Prior to use, the lattice at the end of the grip needs to be widened. This can be easily achieved by pressing the end of the grip against a hard surface, which causes the lattice to expand.



3 The grip should then be placed over the end of the conductor...



4 ...and pushed over the conductor.



5 The grip then needs to be pushed along so that all the lattice is in contact with the conductor.



6 Once the cable grip is in place on the conductor, two clamps should be fitted to the end of the grip (as shown). We recommend between 1 ¼" (30mm) and 2 ¼" (55mm) away from the end of the cable grip.



7 Tape should then be wound around the end of the cable grip furthest away from the eye ends.



8 This will prevent the cable grip from snagging when in use.

## LACE UP CABLE GRIP INSTRUCTIONS

**PLEASE NOTE:** The images shown here use double weave cable grips. When lacing single weave cable grips please use single wire lace; use double-laced for double weave cable grips; and use triple-laced for triple weave cable grips.



1 Start the lacing from the 'eye' end or anchoring end of the cable grip.



2 Thread the lace through the first two loops of the split and pull through until the laces are centered at this point.



3 Don't pull the lace too tight at this stage. Leave a space between adjoining loops roughly equal to the width of one diamond of the mesh.



4 Continue down the length of the cable grip. Try to maintain equal tension and equal spacing throughout as this leads to a more stable and equal grip.



5 As you continue down the length, pull the open sides of the grip as wide apart as required.



6 Try to achieve an even and neat lace-up as this assists with the strength of the grip when pulling.



7 Finally, tie the ends of the lace once or twice round the end of the cable grip twisting the ends together securely. Excess lace can be cut off.



8 Add any additional support as required – banding is recommended. The Slingco cable grip is now ready to use.

TRANSMISSION  
& DISTRIBUTION,  
INDUSTRIAL,  
OIL & GAS,  
AEROSPACE,  
RIGGING, MINING  
& CONSTRUCTION

**SLINGCO  
DELIVERS**

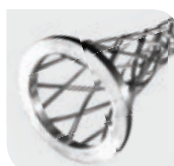

v14\_UK

**Slingco Limited**  
Station Road, Facit, Whitworth,  
Lancashire, OL12 8LJ, England  
Tel: +44 [0]1706 855558  
Fax: +44 [0]1706 855559  
sales@slingco.com

**Slingco America, Inc.**  
130 Celtic Blvd, Tyrone,  
Georgia, 30290, USA  
TOLL FREE: 888 685 9478  
Fax: 888 728 4047  
sales@cablegrip.com



FOR ANY ENQUIRIES CALL TODAY ON  
**+44 [0]1706 855558**

[www.slingco.com](http://www.slingco.com)