

Mechanical In-Line Splice
with Moisture/Contaminant
Block for Medium/High
Voltage Applications

MECHANICAL CONNECTORS

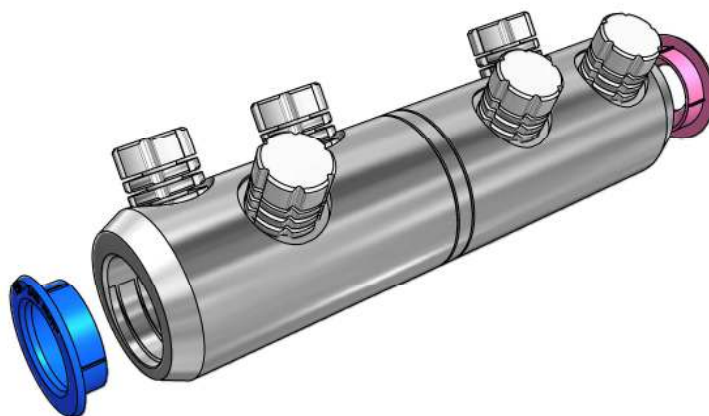







'EUMF' Connectors



Principle Application:

Straight jointing of circular stranded aluminium or copper conductors for all cable voltages up to and including 42kV.

Range:

Connector Reference	Internal Bore (mm ²)	Cable Range (mm ²)						Cable Centralising Rings(s)	
								Colour	Range (mm ²)
		Stranded Circular (mm ²)	Solid Circular (mm ²)	Solid Sector 3 core (mm ²)	Solid Sector 4 core (mm ²)	Stranded Sector	Compacted Circular		
EUMF0	13	16-95	16-95	50	50-70	35-75	16-95	White x 2 Green x 2	16-25 35-50
EUMF1	16	35-150	35-150	25-95	25-95	50-120	35-150	Orange x 2 Purple x 2	35-50 70-95
EUMF2	21	50-240	50-240	50-150	50-185	50-240	50-240	Yellow x 2 Red x 2	50-95 120-150
EUMF2.5	26	95-400	95-400	185-240	185-300	185-240	95-400	Pink x 2 Blue x 2	95-120 150-240
EUMF3	30	240-500	240-500	-300	-	240-300	240-500	Brown x 2	240-300
EUMF8	34	400-630	400-630	-	-	300-400	400-630	-	-
EUMF9	43	800-1000	800-1000	-	-	-	800-1000	-	-

The 'EUMF' range of mechanical connectors incorporate an integral moisture/contaminant block and utilise the MK2 universal range taking shear bolts.

The appropriate tooling is to be used at all times, typical examples shown below.

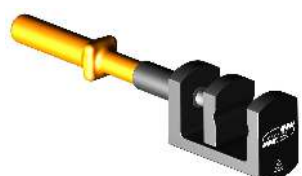

'JTS/22 BR'
Holding Tool



JTS/27 (M18)
JTS/32 (M12)
½"sq Driver



JTS/24 (M18)
JTS/31 (M12)
17 A/F Driver

Mechanical In-Line Splice
with Moisture/Contaminant
Block for Medium/High
Voltage Applications

'EUMF' Aluminium In-Line Splices

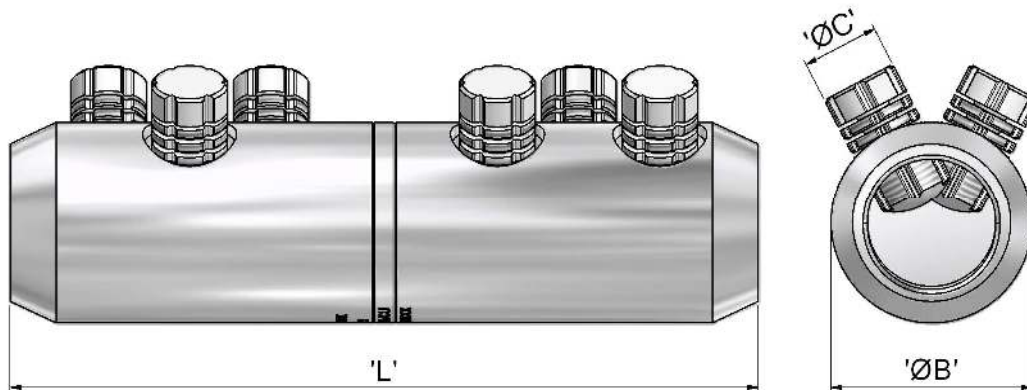

Connector Reference	Dimensions (mm)		
	'L'	'ØB'	'ØC'
EUMF0	60	25	M12 x 2
EUMF1	85	28	M12 x 4
EUMF2	125	34	M18 x 4
EUMF2.5	165	42	M18 x 6
EUMF3	175	47	M18 x 6
EUMF8	175	51	M18 x 6
EUMF9	189	63	M18 x 8

Material: Aluminium Alloy (Electro-Tinned)

Test Specification: BS EN 61238-Class A

Test Report No: TTR/345

Fitting instructions:

1. Strip insulation from each core equal to the depth of the bore.
2. Wire brush the exposed conductor cores and wipe clean (optional).
3. Fit the appropriate sized cable centralising ring (if required).
* **NOTE:** Not required for LV cable cores.
4. Align and position the conductor cores in each of the bores ensuring that the core is fully inserted to the centre wall.
5. Fit the universal shear screws within the connector and torque tighten one turn at a time, using the correct tool, until the bolts have sheared.



THORNE &
DERRICK
INTERNATIONAL

Thorne & Derrick
+44 (0) 191 410 4292
www.powerandcables.com

2.22c