

APPLICATION

The T-OTK is a cold-shrinkable outdoor termination suited for polymeric insulated three-core cables. It will provide a necessary seal against moisture penetration and a perfect electrical field control.

DESIGN

Cold-shrinkable termination comprising:

1. Cable lugs (not included in the standard kit).
2. Water sealing mastic.
3. Silicone rubber tubes with sheds.
4. Silicone rubber tubes.
5. Stress control mastic.
6. Conductive EPDM ring.
7. Silicone rubber protection tubes.
8. Break-out.
9. Flexible tinned copper braid (for use with individual metal tape screened cables).

SPECIFICATIONS AND STANDARDS

The cold-shrinkable T-OTK termination meets the requirements of CENELEC HD 629.1.

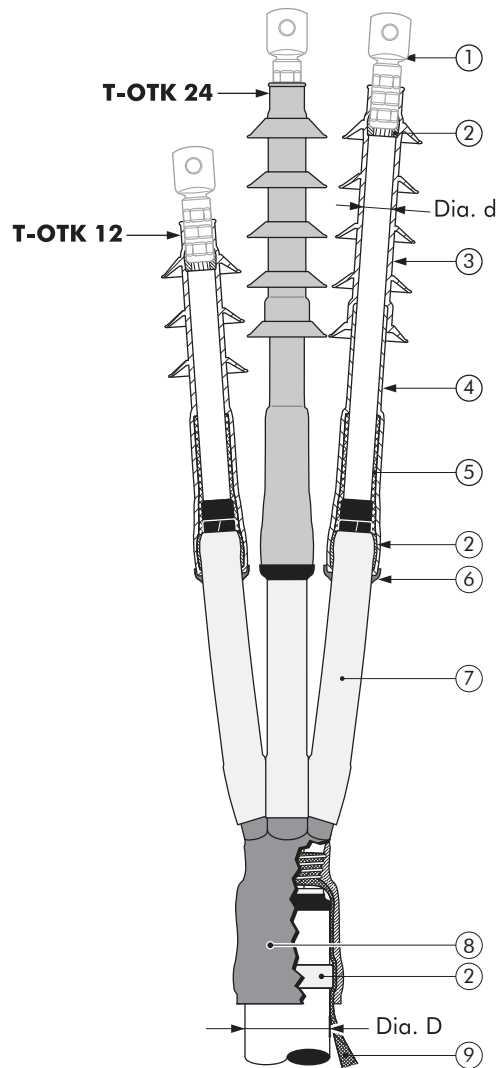

6/10 (12) kV
6.35/11 (12) kV
8.7/15 (17.5) kV
12/20 (24) kV
12.7/22 (24) kV

Up to 24 kV

| Termination type | Voltage U_m (kV) | Diameter over core insulation Dia. d (mm) | | Diameter over outer sheath Dia. D (mm) | | Conductor sizes (for information only) (mm ²) | |
|------------------|--------------------|--|-----|---|-----|---|-----|
| | | min | max | min | max | min | max |
| T-OTK 12-1 | 12 | 16 | 30 | 48 | 90 | 50 | 240 |
| T-OTK 12-2 | 12 | 26 | 42 | 68 | 110 | 240 | 400 |
| T-OTK 24-1 | 24 | 20 | 30 | 48 | 90 | 50 | 185 |
| T-OTK 24-2 | 24 | 26 | 42 | 68 | 110 | 150 | 240 |

05/2017

KIT CONTENTS

The complete cold-shrinkable T-OTK termination kit comprises the following components:

The kit also comprises a roll of adhesive tape, flexible copper braid and installation instructions.

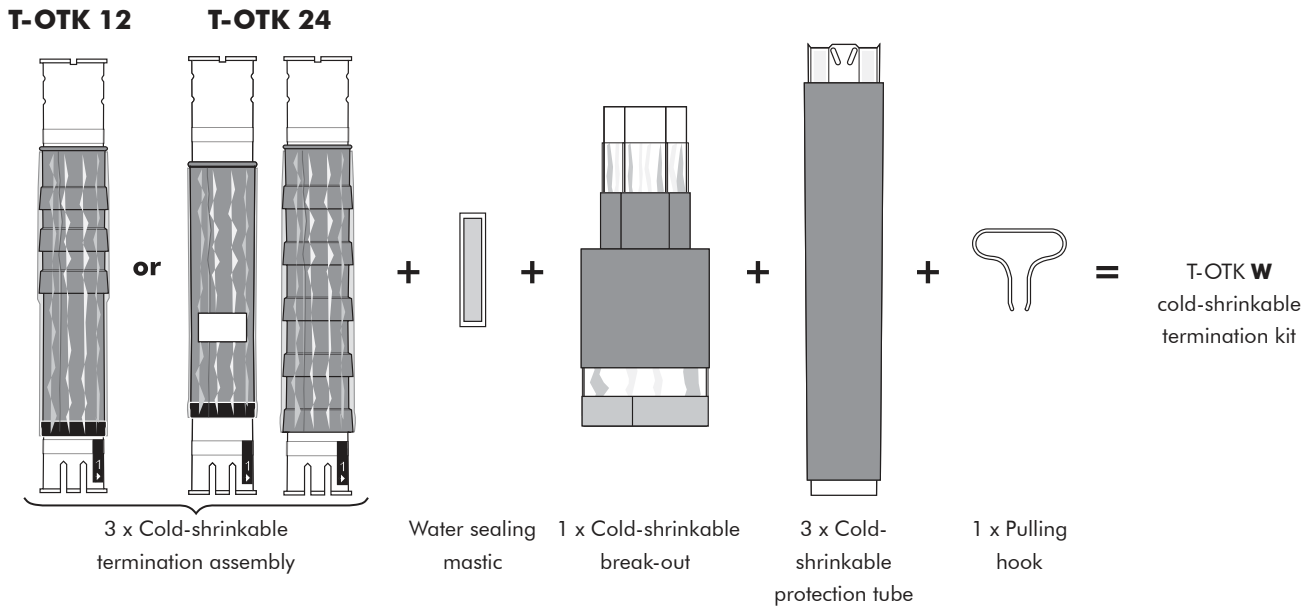

ORDERING INSTRUCTIONS

Select the part number corresponding to both the system voltage and the cable dimensions in mm.

| Ordering part number | Voltage U _m (kV) | Diameter over core insulation (mm) | | Diameter over outer sheath (mm) | |
|----------------------|-----------------------------|------------------------------------|-----|---------------------------------|-----|
| | | min | max | min | max |
| T-OTK 12-1 | 12 | 16 | 30 | 48 | 90 |
| T-OTK 12-2 | 12 | 26 | 42 | 68 | 110 |
| T-OTK 24-1 | 24 | 20 | 30 | 48 | 90 |
| T-OTK 24-2 | 24 | 26 | 42 | 68 | 110 |

EXAMPLE:

The cable is 12 kV, 3 x 150 mm² stranded aluminium, with a diameter of 72.0 mm over outer sheath and 23.5 mm over the core insulation. The cable has an individual copper tape screen. Order a T-OTK 12-1 termination kit.

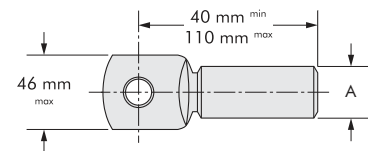

All commercialised European standard cable lugs can be used. Cable lugs should be within the dimensions specified.

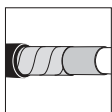

For use with copper tape screened cables. No further earthing device is necessary.

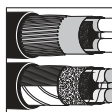

Different armour connections are available. Please contact our representative.



For use with other cable types. Please contact our representative.

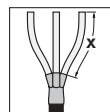

For tail lengths "X" between 650 and 850 mm.

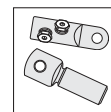

Can be supplied with all common types of cable lugs.

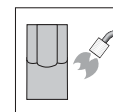

Also available with heat-shrinkable break-out