



Terminations & Accessories

Terminations XLPE / PILC 0.6-33kV	1-5
Coldshrink Terminations 7.2-33kV	6-7
Technical Data	8
Termination Kit Contents	9-12
Bushing Boots / Earth Kits	13
Cold Applied Bushing Boots	14
Bolt On Glands / Armour Earthing	15-17
Insulators and Brackets	18
Termination Observation Study	19-20
Triplex Terminations for 12kV Cables	21

Joints

Triplex 12kV Joints	21
Universal Heat Shrink/Resin Joint 7.2/12kV	22
Universal Heat Shrink Joint 7.2/12kV	23
3 Core Joints XLPE / PILC 17.5-33kV	24-26
Single Core Joints XLPE / PILC	27-28
Earthing / Cross Bonding on Single Cores	29
MV Live Pot End / Abandonment Kits	30
Cold Shrink Joints 7.2 -33kV	31
LV Joints for XLPE / PILC Cables	44-45
Zero Halogen / Fire Resistant Joints	46-47
Airfield Lighting and Traffic Control Joints	48
LV Live Pot End / Abandonment Kits	49

Heat Shrink Components

MV Busbar Tubing	32-34
Anti Track / Sheds / Tape	36
MV Anti Track And Conductive Breakouts	37
Heat Shrink Cable Entry Seals	50
Cable Repair / Busbar Tape	51
Breakout Boots and End Caps	52
Wraparound Repair Sleeves	53
Thin Wall Heat Shrink Sleeve	55
Thick / Medium Wall Heat Shrink Tube	56-57
Zero Halogen LSF Heat Shrink Tube	58

Connectors

MV Copper Compression Lugs / Ferrules	40
MV Aluminium Compression Lugs / Ferrules	41
MV Mechanical Shearbolt Lugs / Ferrules	42
LV Copper Compression Lugs / Ferrules	60
LV Mechanical Shearbolt Ferrules	60

Tapes / Tooling / Misc

MV Busbar Heat Shrink Tape	35
Anti Track Mastic Tape	36
Stress Control Mastic Tapes	38
Roll Springs / Earth Braids / Mesh	39
Cable Preparation Tools	43
LV Busbar Heat Shrink Tape / Nylon Glands	51
Connector Patch Tape	54
Black Melt Tape / Epr Tape / Zero Hal Tape	59
Gas Torch Kits / Crimp Tools / Cable Cutter	61
Termination Clearances Chart	62
Cable Conversion Chart	65





Shrink Polymer Systems

Cable Installation Materials – 24 volts to 36 kV

Unit E3, Crown Way, Crown Park Industrial Estate, Rushden, Northants, UK, NN10 6FD

Tel: +44 (0)1933 356758 Fax: +44 (0)1933 413821 Email: info@shrinkpolymersystems.co.uk

Skype: shrinkpolymersystems www.shrinkpolymersystems.co.uk

The Company

Shrink Polymer Systems was established in 1990 and are based in Northamptonshire in the UK. We also have a joint-venture company based in the Sultanate of Oman and have plans to expand further in the near future.

We specialise in the manufacture of heat shrink and cold shrink cable joints, terminations and cable accessories up to voltage class 33kV.

Whether by phone, email or by site visits, we are here to provide solutions to challenging problems as well as standard applications. Our experienced team have many decades of combined experience in this field.

Quality and Service

If you only want the lowest cost kits, there are others who can help you. If however, you seek:

- **reliable products that will last the life of the cable**
- **technical backup and service 24/7**
- **jointer training and fault analysis**
- **competitive prices and good deliveries**

Then you need to contact us and see why we are the partner of choice for many well known companies both here in the UK and overseas.

At SPS, quality is integral to what we offer and not just because we are registered to the latest ISO 9001:2008 standard.

Export

Our export market continues to increase, by closely working with appointed agents and electric utility companies.

We export to most parts of the world including Europe, The Middle / Far East and Africa. Our website features our customer list, see:

www.shrinkpolymersystems.co.uk

for more details.

We are always interested in working with experienced agents and are open to joint venture possibilities.

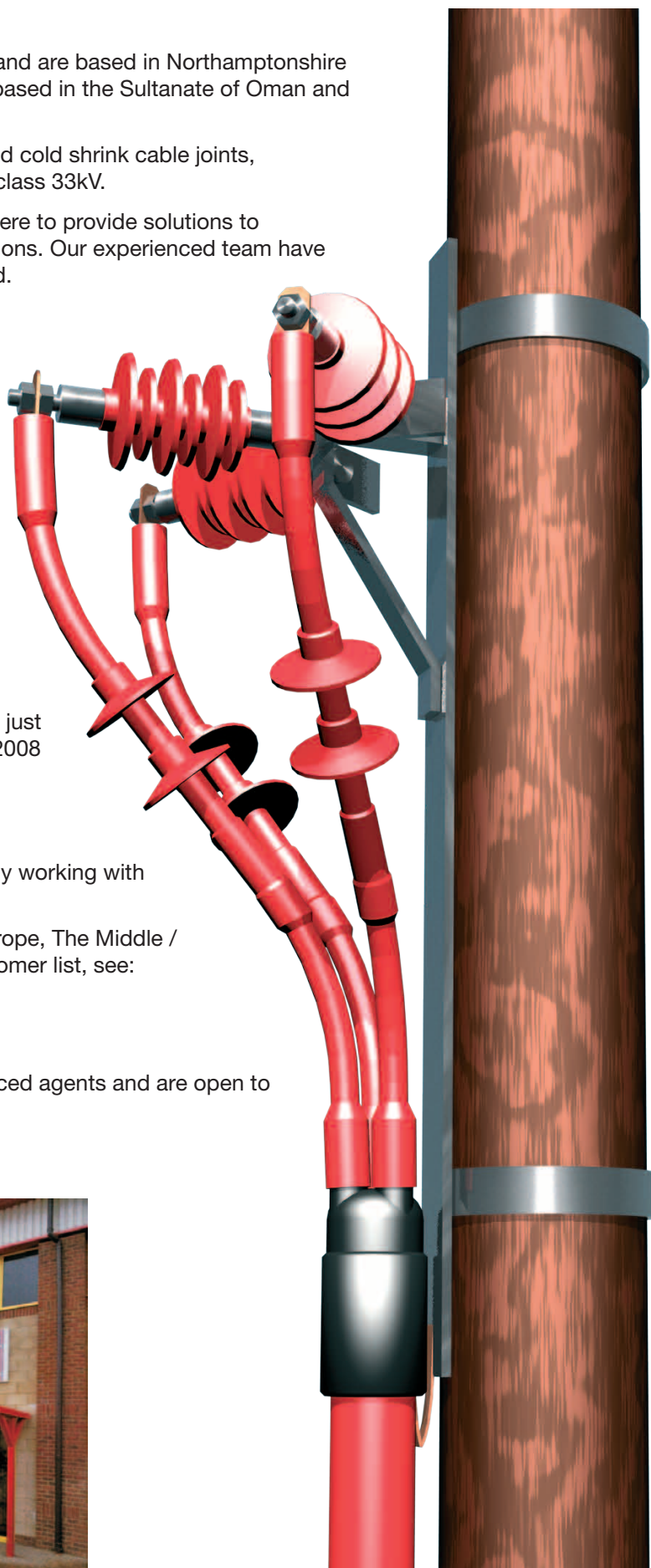



Heat Shrink Terminations 7.2 to 33kV

- Tested to international standards
- Competitive pricing
- Identical to heat shrink systems currently in use, therefore no jointer retraining required
- Thousands already installed worldwide
- Full supporting accessory range



Picture shows XLPE and PILC 12kV Joints and Terminations undergoing type testing to BS 7888 and Cenelec standard HD 628 S1 and HD 629.1 S1 ASTA Test Report Available

Single Core XLPE 7.2kV Terminations

Part Number Indoor	Cable Range	Part Number Outdoor
1TIS-7.2X-A	25-50mm ²	1TES-7.2X-A
1TIS-7.2X-B	70-185mm ²	1TES-7.2X-B
1TIS-7.2X-C	240-300mm ²	1TES-7.2X-C
1TIS-7.2X-D	400-500mm ²	1TES-7.2X-D
1TIS-7.2X-E	630-1000mm ²	1TES-7.2X-E

Three Core XLPE 7.2kV Terminations

Part Number Indoor	Cable Range	Part Number Outdoor
3TIS-7.2X-A	25-50mm ²	3TES-7.2X-A
3TIS-7.2X-B	70-120mm ²	3TES-7.2X-B
3TIS-7.2X-C	150-240mm ²	3TES-7.2X-C
3TIS-7.2X-D	300-500mm ²	3TES-7.2X-D



Single Core XLPE 12kV Terminations

Part Number Indoor	Cable Range	Part Number Outdoor
1TIS-12X-A	16-25mm ²	1TES-12X-A
1TIS-12X-B	35-95mm ²	1TES-12X-B
1TIS-12X-C	120-240mm ²	1TES-12X-C
1TIS-12X-D	300-500mm ²	1TES-12X-D
1TIS-12X-E	630-800mm ²	1TES-12X-E

Three Core XLPE 12kV Terminations

Part Number Indoor	Cable Range	Part Number Outdoor
3TIS-12X-A	16-25mm ²	3TES-12X-A
3TIS-12X-B	35-95mm ²	3TES-12X-B
3TIS-12X-C	120-240mm ²	3TES-12X-C
3TIS-12X-D	300-500mm ²	3TES-12X-D

Standard Tail Lengths

Single Core	Indoor	Outdoor
3.3kV	300	300
7.2kV	350	400
12kV	350	400
17.5kV	410	500
24kV	500	650
33kV	650	800
3 Core	Indoor	Outdoor
3.3kV	600	600
7.2kV	650	700
12kV	650	700
17.5kV	650	700
24kV	700	800
33kV	800	900

Alternative Tail lengths can be supplied. Example: If you require 3 Core 12kV Outdoor Termination for 95mm² cable with 1200mm Tail length, add letter L to code, which then becomes: 3TES-12X-BL



Heat Shrink Terminations 7.2 to 33kV

Single Core XLPE 17.5kV Terminations

Part Number Indoor	Cable Range	Part Number Outdoor
1TIS-17.5X-A	25-70mm ²	1TES-17.5X-A
1TIS-17.5X-B	95-185mm ²	1TES-17.5X-B
1TIS-17.5X-C	240-400mm ²	1TES-17.5X-C
1TIS-17.5X-D	500-630mm ²	1TES-17.5X-D



Three Core XLPE 17.5kV Terminations

Part Number Indoor	Cable Range	Part Number Outdoor
3TIS-17.5X-A	25-70mm ²	3TES-17.5X-A
3TIS-17.5X-B	95-185mm ²	3TES-17.5X-B
3TIS-17.5X-C	240-400mm ²	3TES-17.5X-C

Single Core XLPE 24kV Terminations

Part Number Indoor	Cable Range	Part Number Outdoor
1TIS-24X-A	25-35mm ²	1TES-24X-A
1TIS-24X-B	35-95mm ²	1TES-24X-B
1TIS-24X-C	120-185mm ²	1TES-24X-C
1TIS-24X-D	240-300mm ²	1TES-24X-D
1TIS-24X-E	400-630mm ²	1TES-24X-E

Three Core XLPE 24kV Terminations

Part Number Indoor	Cable Range	Part Number Outdoor
3TIS-24X-A	25-35mm ²	3TES-24X-A
3TIS-24X-B	50-95mm ²	3TES-24X-B
3TIS-24X-C	120-185mm ²	3TES-24X-C
3TIS-24X-D	240-300mm ²	3TES-24X-D



Single Core XLPE 33kV Terminations

Part Number Indoor	Cable Range	Part Number Outdoor
1TIS-36X-A	35-70mm ²	1TES-36X-A
1TIS-36X-B	95-185mm ²	1TES-36X-B
1TIS-36X-C	240-400mm ²	1TES-36X-C
1TIS-36X-D	500-630mm ²	1TES-36X-D

Three Core XLPE 33kV Terminations

Part Number Indoor	Cable Range	Part Number Outdoor
3TIS-36X-A	35-70mm ²	3TES-36X-A
3TIS-36X-B	95-185mm ²	3TES-36X-B
3TIS-36X-C	240-400mm ²	3TES-36X-C



Heat Shrink Terminations 7.2 to 33kV



Single Core PILC 17.5kV Terminations		
Part Number Indoor	Cable Range	Part Number Outdoor
1TIS-12P-A	50-95mm ²	1TES-12P-A
1TIS-12P-B	120-240mm ²	1TES-12P-B
1TIS-12P-C	300-400mm ²	1TES-12P-C
1TIS-12P-D	500-800mm ²	1TES-12P-D

Three Core PILC 17.5kV Terminations		
Part Number Indoor	Cable Range	Part Number Outdoor
3TIS-12P-A	25-50mm ²	3TES-12P-A
3TIS-12P-B	70-95mm ²	3TES-12P-B
3TIS-12P-C	120-185mm ²	3TES-12P-C
3TIS-12P-D	240-400mm ²	3TES-12P-D

Single Core PILC 24kV Terminations		
Part Number Indoor	Cable Range	Part Number Outdoor
1TIS-24P-A	25-50mm ²	1TES-24P-A
1TIS-24P-B	70-185mm ²	1TES-24P-B
1TIS-24P-C	240-300mm ²	1TES-24P-C
1TIS-24P-D	400-630mm ²	1TES-24P-D

Three Core PILC 24kV Terminations		
Part Number Indoor	Cable Range	Part Number Outdoor
3TIS-24P-A	25-50mm ²	3TES-24P-A
3TIS-24P-B	70-95mm ²	3TES-24P-B
3TIS-24P-C	120-185mm ²	3TES-24P-C
3TIS-24P-D	240-300mm ²	3TES-24P-D

Single Core PILC 33kV Terminations		
Part Number Indoor	Cable Range	Part Number Outdoor
1TIS-36P-A	50-95mm ²	1TES-36P-A
1TIS-36P-B	120-185mm ²	1TES-36P-B
1TIS-36P-C	240-400mm ²	1TES-36P-C
1TIS-36P-D	500-630mm ²	1TES-36P-D

Three Core PILC 33kV Terminations		
Part Number Indoor	Cable Range	Part Number Outdoor
3TIS-36P-A	35-70mm ²	3TES-36P-A
3TIS-36P-B	95-185mm ²	3TES-36P-B
3TIS-36P-C	240-400mm ²	3TES-36P-C





Heat Shrink Terminations for use on XLPE and Paper Cables 1.9/3.6kV

In conditions of high humidity, chemical and dust contamination, it is recommended that red anti-track materials are used for extra reliability and long term service.



Single Core PILC / XLPE Indoor / Outdoor Type		
Part Number	Cable Range	Tail Length
1TIS-3.6A	25-70mm ²	300mm
1TIS-3.6B	95-300mm ²	300mm
1TIS-3.6C	400-630mm ²	300mm

3 Core PILC / XLPE Indoor / Outdoor Type		
Part Number	Cable Range	Tail Length
3TIS-3.6A	25-70mm ²	600mm
3TIS-3.6B	95-185mm ²	600mm
3TIS-3.6C	240-400mm ²	600mm



Heat Shrink Terminations for LV PILC Cables 0.6/1kV

3/4 Core PILC Termination		
Part Number	Cable Range	Tail Length
SPS 4-35-600-3	4-35mm ²	600mm
SPS 4-35-1000-3	4-35mm ²	1000mm
SPS 50-150-600-3	50-150mm ²	600mm
SPS 50-150-1000-3	50-150mm ²	1000mm
SPS 185-300-600-3	185-300mm ²	600mm
SPS 185-300-1000-3	185-300mm ²	1000mm

Table above lists part number for 3 core kits, if 4 core, last digit should read - 4

Example: SPS 50-150-600-4

Note: Picture shows outdoor earthing components. If indoor type, the gland kit selected normally takes care of the earthing requirements.

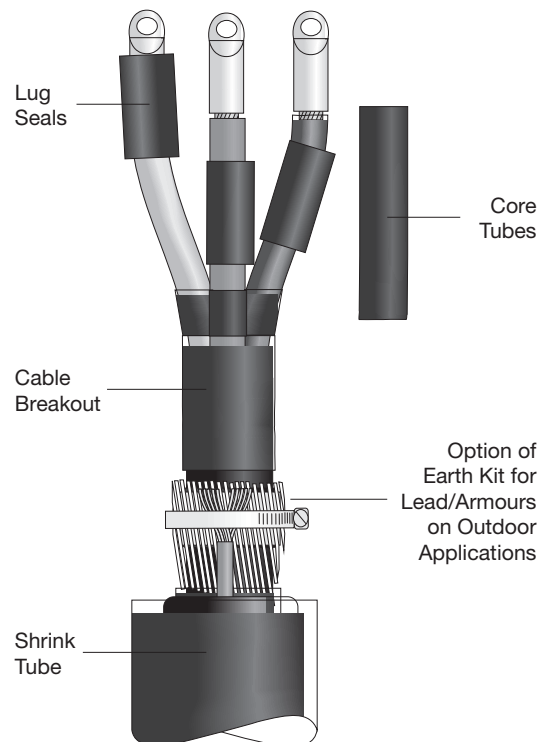



Heat Shrink Terminations XLPE/SWA/PVC Cables 0.6/1kV

2 Core Type	
Part Number	Cable Range
SPS 4-35-2X	4-35mm ²
SPS 35-150-2X	35-150mm ²
SPS 150-400-2X	150-400mm ²

3 Core Type	
Part Number	Cable Range
SPS 10-35-3X	10-35mm ²
SPS 50-95-3X	50-95mm ²
SPS 120-185-3X	120-185mm ²
SPS 185-300-3X	185-300mm ²

4 Core Type	
Part Number	Cable Range
SPS 10-35-4X	10-35mm ²
SPS 50-95-4X	50-95mm ²
SPS 120-185-4X	120-185mm ²
SPS 185-300-4X	185-300mm ²

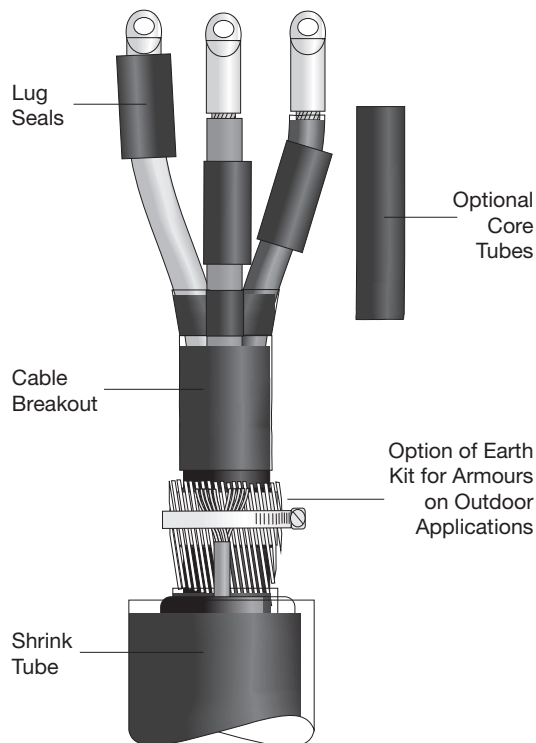

Note: Standard tail length if core tubes are required is 600mm. Terminations for single core cables will be lug seal only. Please specify if alternative length is required.

Earthing Accessories

If earthing of the armours is required, suffix E1=Indoor EO=Outdoor

Example: If a 4 core 185mm² XLPE/SWA/PVC termination with indoor earthing is required the part number would be: SPS 185-300-4XE1.

Bolt on earth glands are also available and are listed on pages 15 and 16.

Test Reports

Independent test reports are available upon request.



Cold Shrink Terminations 7.2 to 33kV

Shrink Polymer Systems offer a cold shrink system that is available for both indoor and outdoor applications for voltage range 7.2 to 33kV.

The main features of the range are as follows:

- **Easy to install with removable spiral system**
- **No gas torches or special tools needed**
- **Tested to International standards**
- **Manufactured from high grade silicone**

Cold shrink type termination products are designed to make the installation of medium voltage cable accessories as simple as possible.

Manufactured from liquid silicone rubber and mounted on a removable/collapsible “spiral type” carrier, components can be easily positioned and fitted in seconds without the need for heat and naked flames which normally involve gas torches and potentially dangerous propane gas bottle on site.

With termination boxes becoming ever more compact, cold shrink components that can be easily fitted, which provide an even wall thickness and constant radial pressure on the prepared cable will, it is envisaged, become the standard over the coming years.





Cold Shrink Terminations Product Selection Charts

Single Core										
Single Core (1)	Termination (T)	Indoor (I) Outdoor (E)	Cold Shrink (CS)	Voltage (kV)	Polymeric (X)	A	B	C	D	E
1	T	I or E	CS	7.2 / 12 /17.5	X	25-50	70-120	150-240	300-400	500-630
1	T	I or E	CS	24	X	25-50	70-120	150-240	300-400	500-630
1	T	I or E	CS	33	X	95-150	185-300	400	500-630	–

3 Core									
3 Core (3)	Termination (T)	Indoor (I) Outdoor (E)	Cold Shrink (CS)	Voltage (kV)	Polymeric (X)	A	B	C	D
3	T	I or E	CS	7.2 / 12 /17.5	X	25-50	70-120	150-240	300-400
3	T	I or E	CS	24	X	25-50	70-120	150-240	300-400
3	T	I or E	CS	33	X	95-150	185-300	400	–

Note: Single core kits contain 3 x single phases

Order Examples		
Termination	Cable Type / Size	Part Number
Indoor 15kV	Single core XLPE 95mm ²	1TICS-17.5X-B
Indoor 12kV	3 core XLPE 95mm ²	3TICS-12X-B
Outdoor 17.5kV	3 core XLPE 150mm ²	3TECS-17.5X-C
Outdoor 33kV	Single core XLPE 400mm ²	1TECS-36X-C

Please specify transformer / switchgear box length (Base plate to lug fixing point at time of ordering).

Note: Cold Shrink joints are also available, see page 31 for more details.



Technical Data

Heat Shrink Terminations / Joints 7.2 to 33kV

Summary of Test Voltages						
Test	Test Voltage	Rated Voltage U_0/U_m (kV)				
		3.8/6.6 (7.2)	6.35/11 (12)	8.7/15 (17.5)	12.7/22 (24)	19/33 (36)
Humidity and salt fog	$1.25 U_0$	5	8	11	16	24
Partial discharge	$1.73 U_0$	6.5	11	15	22	33
	$2 U_0$	7.5	12.5	17.5	25	38
Heating cycle voltage and AC voltage / 15 min and 500 hrs	$2.5U_0$	9.5	16	23	32	47.5
AC voltage / 1 min	$4U_0$	15	25.5	35	51	76
AC voltage / 5 min	$4.5U_0$	17	28.5	39	57	85.5
DC voltage / 15 min	$6U_0$	23	38	52	76	114
Impulse (peak)	–	60	95	95	125	194

Test Sequence and Requirements						
	Test	Test Clause of EN 61442	Test Sequence			Test Requirements
			A1	A2	A3	
1	DC voltage dry	5	X	X		15 min at $6U_0$ no breakdown or flashover
2	AC voltage dry	4	X	X		5 min at $4.5 U_0$ no breakdown or flashover
3	Partial discharge at ambient temperature	7	X			Max 10_pC at $1.73U_0$ ⁽⁴⁾
4	Impulse voltage at elevated temperature	6	X			10 impulses of each polarity, no breakdown or flashover
5	Heating cycle voltage in air	9	X			126 cycles at $2.5U_0$ no breakdown or flashover for terminations and 63 cycles in air and 63 cycles in water for Joints
6	Partial discharge at elevated and ambient temperature	7	X			Max 10_pC at $1.73U_0$ ⁽⁴⁾
7	Thermal short circuit (screen)	10		X		2 short circuits at 1_{sc} no breakdown
8	Thermal short circuit (conductor)	11		X		2 short circuits to raise conductor to 6_{sc} of the cable, no breakdown
9	Dynamic short circuit	12		X		1 short circuit at 1_d ⁽³⁾ no breakdown
10	Impulse voltage at ambient temperature	6	X	X		10 impulses of each polarity, no breakdown or flashover
11	AC voltage dry	4	X	X		15 min at $2.5U_0$ no breakdown or flashover
12	Humidity ⁽²⁾	13			X	300 hrs duration at $1.25U_0$ ⁽⁵⁾
13	Examination	-	X	X	X	For information only

Shrink Polymer Systems test and qualify our products to the criteria above as outlined in Cenelec standards HD 628 S1 and 629.1 S2:2006. This testing criteria also encompasses VDE 0278 and IEC 60502



Kit Contents – Single Core Heat Shrink Terminations for XLPE or Epr Cables 7.2 to 33kV

Indoor



Kit Contents	
Anti-Track Core Tubes	Qty 3
Stress Control Tubes	Qty 3
Yellow Stress Relief Tape for Screen Ends	Qty 3
Red Mastic Sealing Tape	Qty 1
De-Grease Tissues	Qty 3
Box, Label, Instructions	Qty 1

Optional Accessories
Earth Spring Kit For Cu Tape Screens
Bushing Protection Boots
Bolt On Heat Shrink Earth Gland
Stand Off Bracket / Insulators
Armour Earthing (Outdoor)
MV Water Blocked Lugs
MV Mechanical Shearbolt Lugs

Outdoor

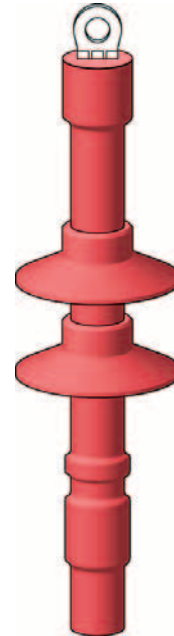

Kit Contents	
Anti-Track Core Tubes	Qty 3
Stress Control Tubes	Qty 3
Stress Relief Tape for Screen Ends	Qty 3
Red Mastic Sealing Tape	Qty 1
De-Grease Tissues	Qty 3
Rain Sheds	Qty *
Box, Label, Instructions	Qty 1

* See table below for number of sheds

Per Phase	Indoor	Outdoor
7.2kV	0	1
12kV	0	2
17.5kV	0	2
24kV	0	3
36kV	1	4



Kit Contents - Single Core Heat Shrink Terminations for PILC Cables 7.2 to 33kV

Indoor



Kit Contents	
Anti-Track Core Tubes	Qty 3
Oil Barrier Tubes	Qty 3
Stress Control Tubes	Qty 3
Yellow Stress Relief Tape for Screen Ends	Qty 3
Red Mastic Sealing Tape	Qty 1
De-Grease Tissues	Qty 3
Box, Label, Instructions	Qty 1

Optional Accessories
Bushing Protection Boots
Bolt On Heat Shrink Earth Gland
Stand Off Bracket/Insulators
Armour Earthing (Outdoor)
MV Water Blocked Lugs
MV Mechanical Shearbolt Lugs

Outdoor

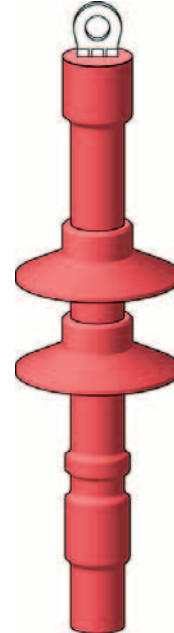

Kit Contents	
Anti-Track Core Tubes	Qty 3
Oil Barrier Tubes	Qty 3
Stress Control Tubes	Qty 3
Stress Relief Tape for Screen Ends	Qty 3
Red Mastic Sealing Tape	Qty 1
De-Grease Tissues	Qty 3
Rain Sheds	Qty *
Box, Label, Instructions	Qty 1

* See table for number of sheds

Per Phase	Indoor	Outdoor
7.2kV	0	1
12kV	0	2
17.5kV	0	2
24kV	0	3
36kV	1	4



Kit Contents – 3 Core Heat Shrink Terminations for XLPE or Epr Cables 7.2 to 33kV

Indoor

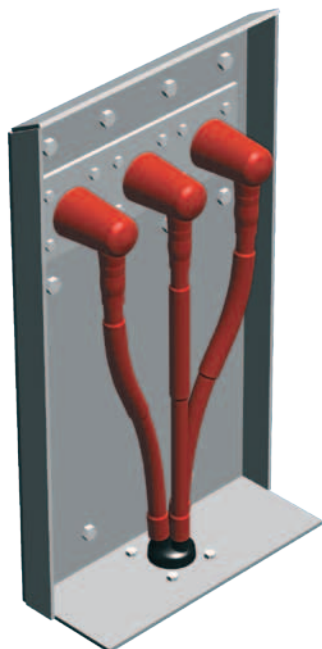

Kit Contents	
Anti-Track Core Tubes	Qty 3
Stress Control Tubes	Qty 3
Yellow Stress Relief Tape for Screen Ends	Qty 3
3 Core Breakout Boot	Qty 1
Red Mastic Sealing Tape	Qty 1
De-Grease Tissues	Qty 3
Box, Label, Instructions	Qty 1

Optional Accessories
Earth Spring Kit For Cu Tape Screens
Bushing Protection Boots
Bolt On Heat Shrink Earth Gland
Stand Off Bracket/Insulators
Armour Earthing (Outdoor)
MV Water Blocked Lugs
MV Mechanical Shearbolt Lugs

Outdoor

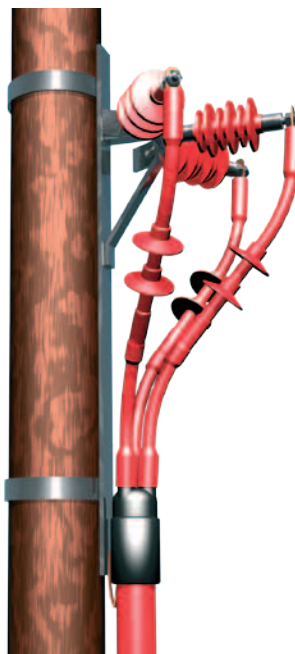

Kit Contents	
Anti-Track Core Tubes	Qty 3
Stress Control Tubes	Qty 3
Stress Relief Tape for Screen Ends	Qty 3
3 Core Breakout Boot	Qty 1
Red Mastic Sealing Tape	Qty 1
De-Grease Tissues	Qty 3
Rain Sheds	Qty *
Box, Label, Instructions	Qty 1

* See table below for number of sheds

Per Phase	Indoor	Outdoor
7.2kV	0	1
12kV	0	2
17.5kV	0	2
24kV	0	3
36kV	1	4



Kit Contents - 3 Core Heat Shrink Terminations for PILC or PICAS Cables 7.2 to 33kV

Indoor

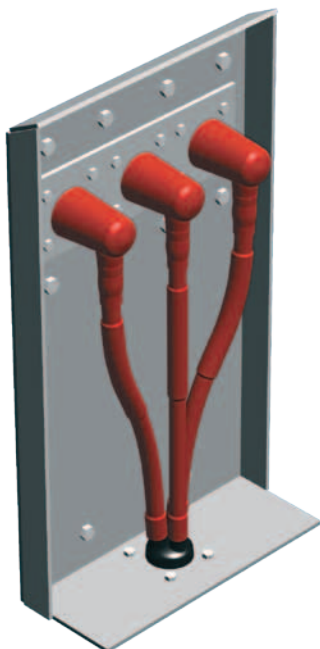

Kit Contents	
Anti-Track Core Tubes	Qty 3
Oil Barrier Clear Tubes	Qty 3
Stress Control Tubes	Qty 3
Yellow Stress Relief Tape (If Screened Cable)	Qty 3
Mastic Crutch Wedge	Qty 1
3 Core Conductive Boot	Qty 1
Mastic Sealing Tape Roll	Qty 1
Red Mastic Sealing Tape	Qty 1
De-Grease Tissues	Qty 3
Box, Label, Instructions	Qty 1

Optional Accessories
Bushing Protection Boots
Bolt On Heat Shrink Earth Gland
Stand Off Bracket/Insulators
Armour/Lead Earthing (Outdoor)
Mv Water Blocked Lugs
Mv Mechanical Shearbolt Lugs

Outdoor

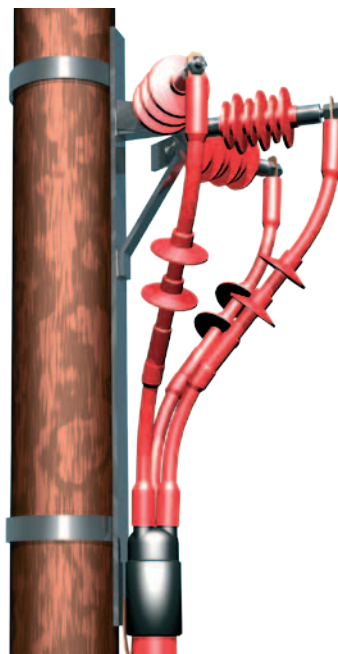

Kit Contents	
Anti-Track Core Tubes	Qty 3
Oil Barrier Clear Tubes	Qty 3
Stress Control Tubes	Qty 3
Yellow Stress Relief Tape (If Screened Cable)	Qty 3
Mastic Crutch Wedge	Qty 1
3 Core Conductive Boot	Qty 1
Mastic Sealing Tape Roll	Qty 1
Red Mastic Sealing Tape	Qty 1
De-Grease Tissues	Qty 3
Strain Relief Tri Shed	Qty 1
Rain Sheds	Qty *
Box, Label, Instructions	Qty 1

* See table below for number of sheds

Per Phase	Indoor	Outdoor
7.2kV	0	1
12kV	0	2
17.5kV	0	2
24kV	0	3
36kV	1	4



Heat Shrink Bushing Protection Boots 7.2 to 33kV

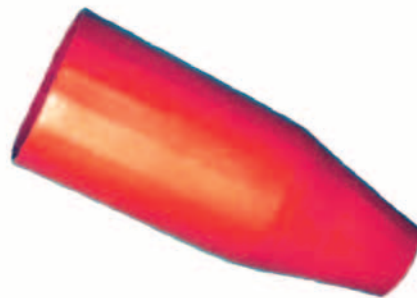
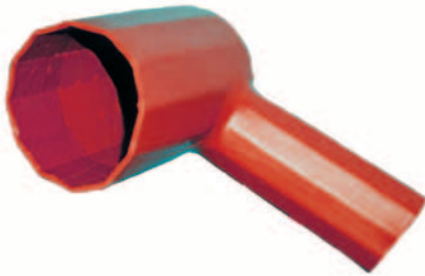

Part Number	Cable Range	Voltage
RABK 1-2	16-300mm ²	7.2-17.5kV
RABK 3	150-800mm ²	7.2-17.5kV
RABK 1-2 (24)	35-240mm ²	24kV
RABK 4	50-630mm ²	33kV

Part Number	Cable Range	Voltage
STBK 1-2	16-300mm ²	7.2-17.5kV
STBK 3	400-800mm ²	7.2-17.5kV
STBK 1-2 (24)	35-240mm ²	24kV
STBK 4	50-630mm ²	33kV

Solderless Earth Kits for Copper Tape Screens 7.2 to 33kV

Voltage					Part No
7.2kV	12kV	17.5kV	24kV	33kV	
Conductor Size (mm ²)					
25-50	25-50	25-50	–	–	SPS 204
70-95	70-95	70-95	35-70	–	SPS 205
120-240	120-240	120-240	95-185	50-70	SPS 206
300-630	300-630	300-630	240-500	95-300	SPS 207
–	800-1000	800-1000	630-800	400-630	SPS 208
–	–	–	–	800-1000	SPS 209

Each kit contains a set of three.

If 3 core system suffix part number (3c)

If 1 core system suffix part number (1c)

Example: 70-95mm² kit for 3 core 12kV cable would be SPS 205(3c)

Note: a moisture/solder block is incorporated in each braid for cable sizes not listed please contact Shrink Polymer Systems

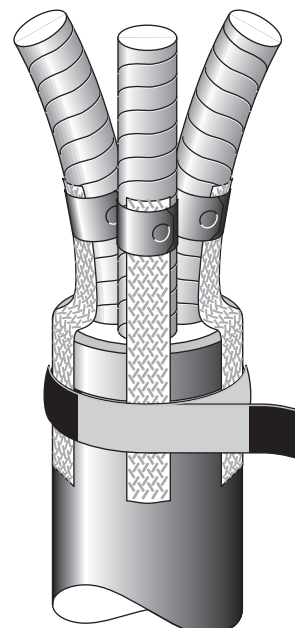



Medium Voltage Cold Applied Bushing Protection Boots 7.2 to 17.5kV

- One size for right angle and straight
- configuration 35-400mm² at 7.2-17.5kV
- Unique bushing adaptor provides superior moisture ingress protection
- Longer than existing designs in the market to allow for use with longer barrel lugs
- Fully tested with successful pass at 95kV impulse levels (test report available)

Shrink Polymer Systems now offer our own universal medium voltage cold applied bushing protection boot for switchgear and transformer connections.

Manufactured from high grade silicone with excellent non tracking and erosion resistance, the boot is very flexible and just one size covers right angle or straight connections for cable sizes 35-400mm². In addition to being longer than existing designs in the market which helps when being used with longer barrel lugs such as shearbolt connectors, the seals at both the bushing end and cable clamping end have been improved.



Part Number	Bushing Diameters
SPCAB 35-400SA	30-40mm
SPCAB 35-400	42-70mm

Unique Bushing Adaptor
Overlaps Boot to provide
an enhanced seal

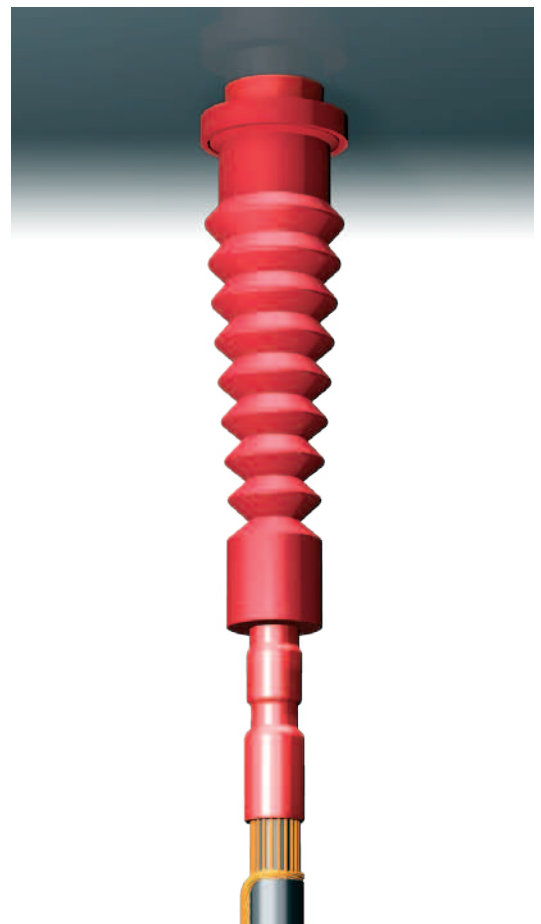
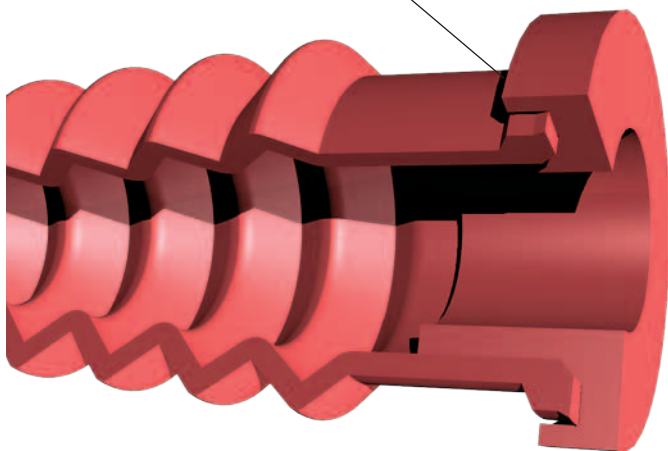



Bolt on Heat Shrink Earth Gland Kits 7.2 to 33kV

- Designed for use with a wide range of cable boxes
- Stud spacings to BS 2562
- Cast integral earth allows for use with medium voltage installations
- All cable types catered for
- Smaller gland has dual stud fixings size X and Y to BS 2562



Steel Glands for Three Core Cables						
Voltage					Part No	Cable Type
7.2kV	12kV	17.5kV	24kV	33kV		
Conductor Size (mm ²)						
16-150	16-95	16-95	35-50	–	SPS 180	XLPE
185-400	120-400	120-400	70-300	35-185	SPS 193	XLPE
16-70	16-70	16-70	16-70	–	SPS 318	PILC
95-150	95-150	95-150	95-150	–	SPS 319	PILC
185-300	185-300	185-300	185-300	50-240	SPS 320	PILC
25-185	25-185	25-185	–	–	SPS 452	PICAS
240-400	240-400	240-400	–	–	SPS 453	PICAS

Note: For Bolt on Glands for Triplex Cables, see Page 21



Aluminium Glands For Single Core Cables

For single core XLPE aluminium wire armoured cables and single core lead sheathed cables, the main bolt on gland body is manufactured from aluminium.

The kits listed below are generally supplied as a set of three. Additional components are similar to those within the kits shown on page 16.

Part No	Cable Range	Cable Type	Voltage
SPS 560	50-630mm ²	XLPE/AWA	7.2-36kV
SPS 561	150-1000mm ²	PILC	12kV



Bolt on Gland Components

Standard Gland Unit

The standard gland is the SPS 180 and SPS 193, they are intended for use on three core XLPE/SWA cable.

Kit Contents		
1	Steel Gland Body Qty 1	
2	Thick Wall Adhesive Lined Tube	Qty 1
3	Gland Body Fixing Pack	Qty 1
4	Armour Clamps	Qty 2
5	Cleaning Tissue	Qty 1
6	Installation Instruction Sheet	Qty 1



Earth Kit For PILC Cables

For paper insulated or XLPE cables with a lead sheath, an additional earth kit is included with the main gland kit listed above.

Additional Kit Contents		
1	Thick Wall Adhesive Lined Tube	Qty 1
2	Copper Earth Strap	Qty 1
3	Constant Force Roll Spring	Qty 1
4	Cleaning Tissue	Qty 1
5	Installation Instructions	Qty 1



Earth Kit For PICAS Cables

For paper insulated cables with a corrugated aluminium sheath, an additional earth kit is included with the main gland kit listed above.

Additional Kit Contents		
1	Thick wall adhesive lined tube	Qty 1
2	Copper earth strap	Qty 1
3	Perforated tinned copper strip	Qty 1
4	Armour clamps	Qty 2
5	Cleaning tissue	Qty 1
6	Installation instructions	Qty 1

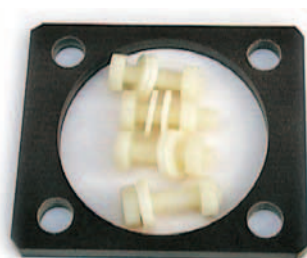

Insulating Plate

If Insulating Plate is required for CT applications or separate earthing, an additional kit is required which contains a pre-drilled Insulating plate complete with Insulated fixings see Part Number: SPS 464



Outdoor Armour Earth Kits for Single Core and 3 Core Cables 3.3 to 33kV

In installations where an earth gland is not fitted or on outdoor pole mounted installations, armour earthing kits can be supplied for all cable types up to 36kV.

Typical Kit Contents for XLPE Insulated Cables	
1	Armour support rings
2	Armour clamps
3	Insulated copper earth wire/braids
4	Mastic sealant tape
5	Adhesive lined heat shrink sealing tube
6	Cable cleaning tissues
7	Installation instructions

Typical Kit Contents for Paper Insulated Cables

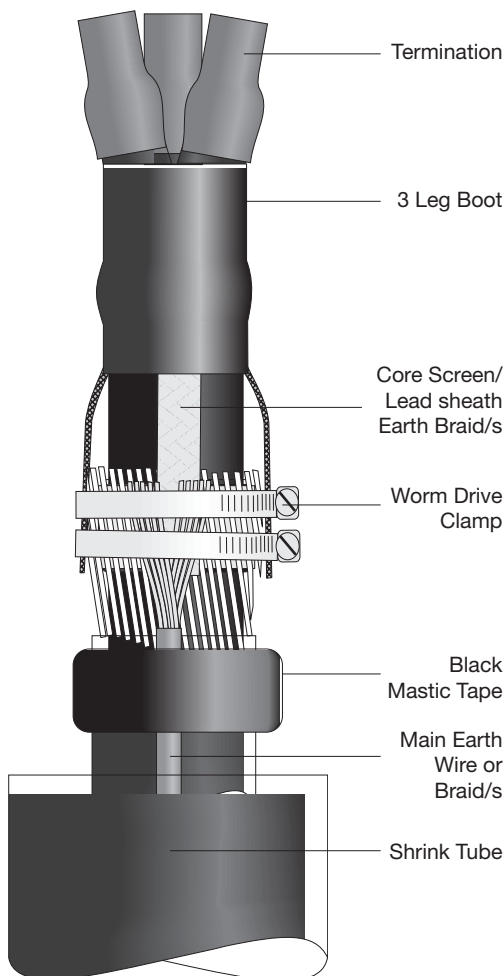

As above but with the addition of a copper earth strap and stainless steel roll spring/s for PILC or perforated tinned copper strip for PICAS cables.

Reference numbers are obtained by taking the termination part number and substituting TIS (termination, indoor, shrink) or TES (termination, outdoor, shrink) with OAE (outdoor armour earthing).

Examples:

1) If the cable is 3 core 12kV PILC 95mm² the kits required for indoor installations are as follows:

Termination kit	3TIS-12P-B
Armour earth kit	30AE-12P-B

The same armour earth kit would be used on outdoor installations.

2) If the cable is single core 33kV XLPE 400mm² the kits required for outdoor installations are as follows:

Termination kit	1TES-36X-C
Armour earth kit	10AE-36X-C

The same armour earth kit would be used on indoor installations.



Stand Off Brackets and Insulators

Where terminations are to be mounted on outdoor installations, Shrink Polymer Systems can offer a range of high quality stand off insulators for voltages up to 36kV.

The polymeric insulator consists of a fibreglass core covered with a weather resistant polymeric shedded sleeve. These insulators offer superior performance in polluted environments, are flame/arc resistant and UV stable. Where as porcelain type can be easily damaged, polymeric type insulators are less prone to damage by vandals.

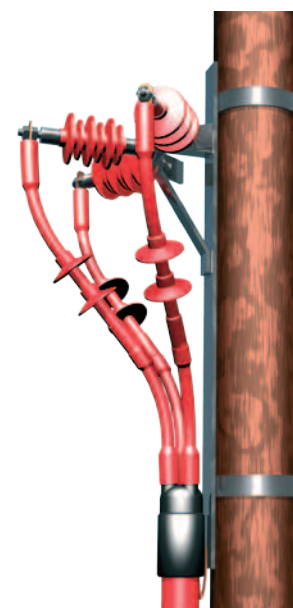

Tests on Composite Insulators	IEC 1109
Electrical Qualification	BS 383
Environmental Testing	IEC 1109 annex C
Creepage Distance Ratios	IEC 815
Thermal Endurance	IEC 60216
Metalwork Protective Coating	BS 729

12-17.5kV Type Parameters	
Rated Voltage	17.5kV
Impulse Voltage with stand	125kV
Wet Voltage with Stand	50kV
Creepage Distance	450mm
Weight Each	0.85kg
Cantilever Deflection at 1kn Load	18mm

Insulators	Part No: SPS 465
Bracket	Part No: SPS 316

33kV Type Parameters	
Rated Voltage	33kV
Impulse Voltage with stand	170kV
Wet Voltage with Stand	75kV
Creepage Distance	1050mm
Weight Each	2.5kg
Cantilever Deflection at 1Kn Load	25mm

Insulators	Part no: SPS 509
Bracket	Part no: SPS 317

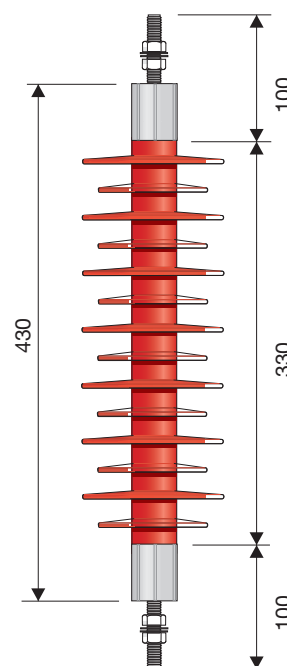
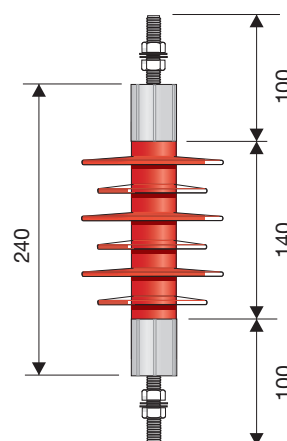



Medium Voltage Termination – Observations

Indoor 3 Core XLPE Termination Installed Using Alternative Improved Clearance Dimensions

Picture 1 shows the termination in varying stages of completion. Please note: The installation instruction provided with each kit details both the standard cable preparation details and the dimensions for the improved clearance option.

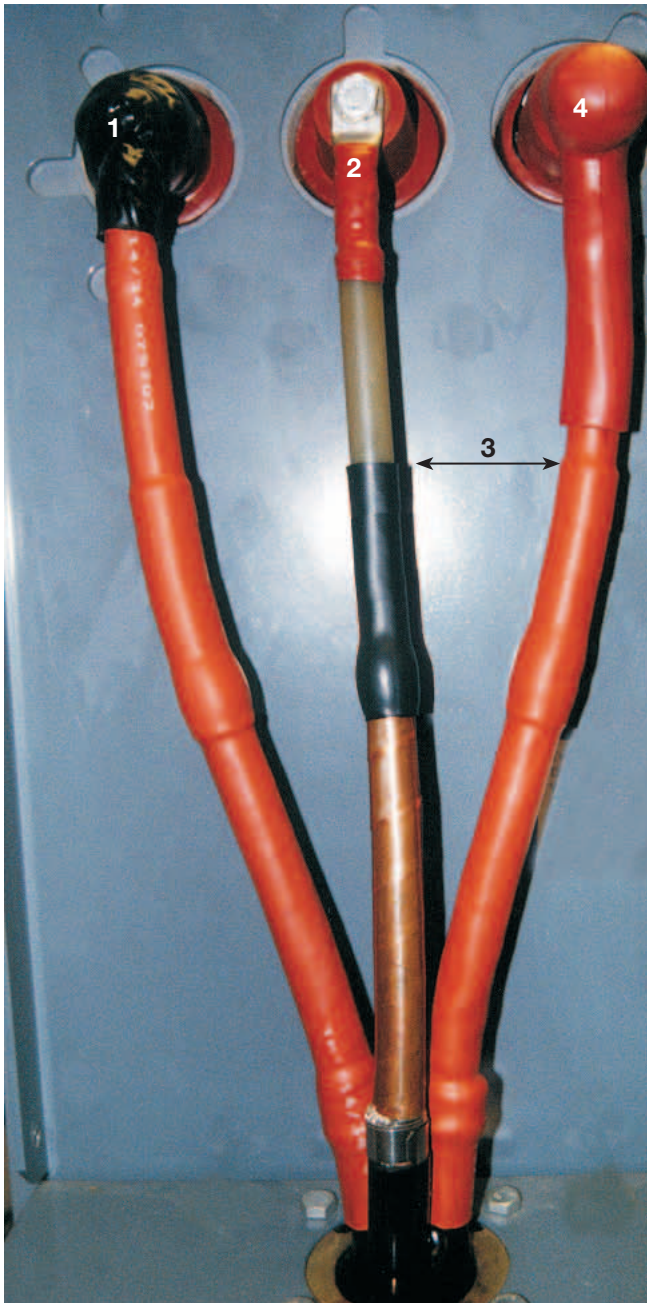

Picture 1

Observations

1. Shows the application of the mastic melt tape to the bushing and to the metalwork. This not only ensures an additional moisture seal but improves impulse voltage withstand levels from 75 to 95kV.
2. Shows the application of the red anti-track sealant tape over the lug barrel.
3. Shows the position of the stress control tube which in this example has been fitted in a higher position up the core with the following additional benefits:
 - a. Improved clearance dimensions between phases at the top of stress control tubes, which also gives the user the ability to core cross whilst still retaining the required clearances.
 - b. Not only does it save the installer time because less screen material is removed, it makes it far easier to use screen removal tools in between the cores.
 - c. It is easier to use a gas torch between the cores at a higher point, resulting in the increased likelihood that even shrinkage of both stress control and anti-track tube is achieved at the end of the screen point.
4. Shows the installation of the right angle bushing protection boot. A shorter skirt version is also available for short bushings.



Medium Voltage Termination – Observations

Indoor 3 Core PILC Termination Installed with Optional Improved Clearance/Core Crossing Kit

Picture 2 shows the termination in varying stages of completion. Please note: The improved clearance/core crossing kit is an optional item that can be ordered in addition to the standard termination.

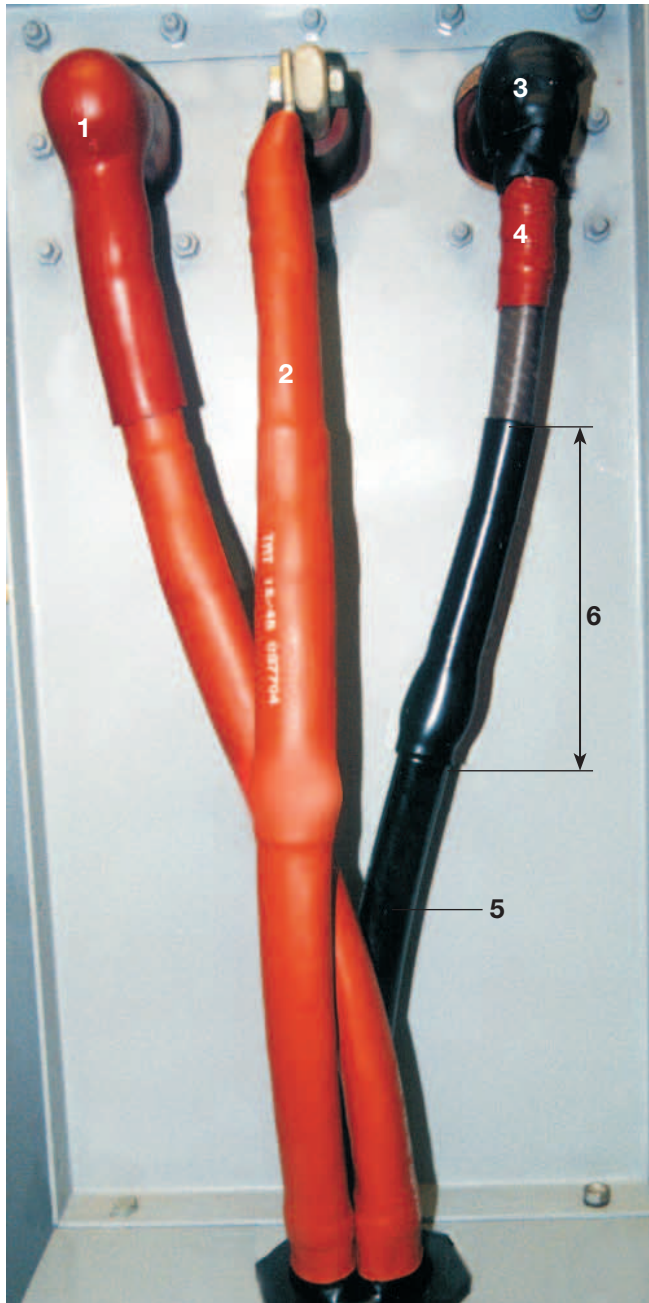

Picture 2

Observations

1. Shows the installation of a right angle bushing protection boot. A shorter skirt version is also available for where short bushings exist.
2. Shows the centre phase anti-track tube having been fitted. The tube is printed with both size and batch code.
3. Shows the application of the mastic melt tape to the bushing and to the metalwork. This not only ensures an additional moisture seal but improves impulse voltage withstand levels from 75 to 95kV.
4. Shows the application of the red anti-track sealant tape being applied to the lug barrel.
5. In order to improve phase to phase clearance dimensions under normal circumstances, or when a core cross is applied, conductive tubes are fitted to each core. This allows you to fit the stress control tubes at a higher position.
6. Shows the position of the stress control tube which in this case has been fitted in a higher position up the core with the following additional benefits:
 - a. Improved clearance dimensions between phases at the top of stress control tubes, which also gives the user the ability to core cross whilst still retaining the required clearances.
 - b. It is easier to use a gas torch between the cores at a higher point, resulting in the increased likelihood that even shrinkage of both stress control and anti-track tube is achieved at the end of screen point.



Terminations / Joints and Accessories for 11kV Triplex Cable

Triplex cable is essentially 3 x single core cables spun together in “triplex” formation. Used extensively by the UK electricity companies and medium voltage jointing contractors, it’s easier and quicker to install than either 3 core or separate single core cables.

Shrink Polymer Systems offer a range of products from stock to suit.



Terminations		
Part Number Indoor	Cable Range	Part Number Outdoor
1TIS-12TX-B	95-185mm ²	1TES-12TX-B
1TIS-12TX-C	300mm ²	1TES-12TX-C

For Bushing Protection Boots, see page 13 and 14

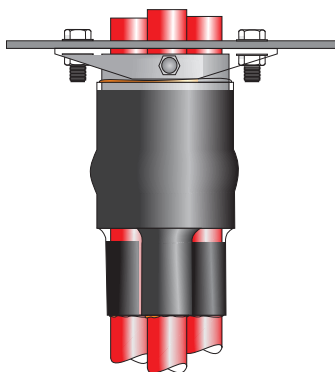

Bolt On Heat Shrink Glands	
Part Number	Cable Range
SPS 1197	95mm ²
SPS 1095	185-300mm ²

Heat Shrink Joints	
Part Number	Cable Range
SPJ 12TX-95-185-1	95-185mm ²
SPJ 12TX-185-300-1	185-300mm ²

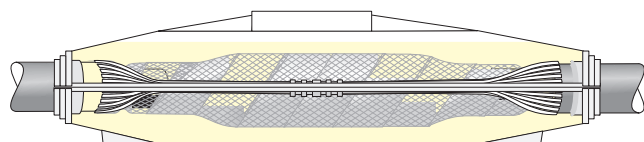

Heat Shrink / Resin Combination Joints	
Part Number	Cable Range
SPUJ 12TX-95-185-1	95-185mm ²
SPUJ 12TX-185-300-1	185-300mm ²

Notes: For cold applied or heat shrink bushing protection boots, see page 13 and 14. For shearbolt mechanical lugs and ferrules, see page 42. For cable preparation tools, see page 43. For trifurcating joints (3 core to 3 x single core, see page 23) Cold shrink versions of the above can also be supplied



Universal Heat Shrink / Resin Combination Joint for 7.2 to 12kV Cables

- Suits 3 core XLPE / PILC / PICAS cables or transition combinations complete with tapered range taking mechanical connectors, high impact shell and twin pack polyurethane resin
- Offers the superior insulation benefits of heat shrink combined with resin for environmental protection
- Tested to BS7888 and Cenelec HD 628 S1 and HD 629 S1

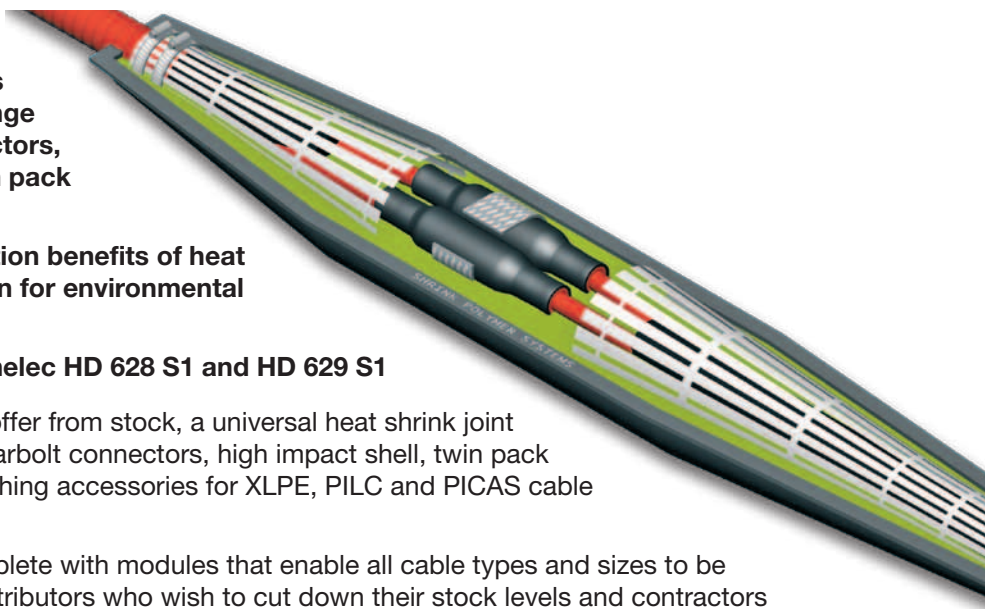

Shrink Polymer Systems now offer from stock, a universal heat shrink joint complete with mechanical shearbolt connectors, high impact shell, twin pack polyurethane resin and full earthing accessories for XLPE, PILC and PICAS cable combinations.

The standard joint comes complete with modules that enable all cable types and sizes to be catered for. This is ideal for distributors who wish to cut down their stock levels and contractors that cannot be sure of the exact cables they will encounter on site.

Where the cables are known, only the modules required can be supplied to further reduce cost. Mechanical connectors can be substituted for compression connectors if preferred.

Part Number	Conductor Size	Cable Types
SPUJ 12U 35-70-3	35-70mm ²	XLPE/PILC/PICAS
SPUJ 12U 95-185-3	95-185mm ²	XLPE/PILC/PICAS
SPUJ 12U 185-300-3	185-300mm ²	XLPE/PILC/PICAS
SPUJ 12X 35-70-3	35-70mm ²	XLPE
SPUJ 12X 95-185-3	95-185mm ²	XLPE
SPUJ 12X 185-300-3	185-300mm ²	XLPE
SPUJ 12PX 35-70-3	35-70mm ²	Transition
SPUJ 12PX 95-185-3	95-185mm ²	Transition
SPUJ 12PX 185-300-3	185-300mm ²	Transition
SPUJ 12P 35-70-3	35-70mm ²	PILC/PICAS
SPUJ 12P 95-185-3	95-185mm ²	PILC/PICAS
SPUJ 12P 185-300-3	185-300mm ²	PILC/PICAS



Non Centralised Type Connectors



SPS Joint has tapered Profile with Conductors Centralised

Notes: Items 1-3 are the universal type, items 4-12 have only the required modules. Trifurcating joints are available.

Example: 3c 95mm² PILC to 3 x Single Core 95mm² XLPE = SPUJ 12PX-95-185-3-TRIF

Universal Heat Shrink Range Taking Joint for 7.2 to 12kV Cables

- Suit 3 Core XLPE / PILC / PICAS Cables or transition complete with tapered range taking mechanical connectors
- Modular in design
- Can be installed vertically
- Trifurcating applications catered for
- Tested to BS7888 and Cenelec HD 628 S1 and HD 629 S1

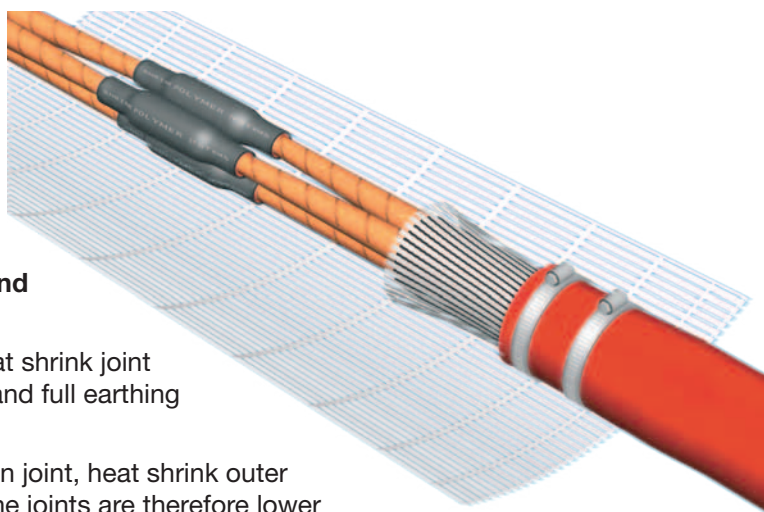

Shrink Polymer Systems now offer a universal heat shrink joint complete with mechanical shearbolt connectors and full earthing accessories for XLPE, PILC and PICAS cables.

Based on the uniset heatshrink / resin combination joint, heat shrink outer tubes are used instead of outer shell and resin. The joints are therefore lower in cost, quicker to install and can be installed on uneven planes including vertical installations.

Where the cables are known, only the modules required can be supplied to further reduce cost. Mechanical connectors can be substituted for compression connectors if preferred.

Part Number	Conductor Size	Cable Types
SPAJ 12U 35-70-3	35-70mm ²	XLPE/PILC/PICAS
SPAJ 12U 95-185-3	95-185mm ²	XLPE/PILC/PICAS
SPAJ 12U 185-300-3	185-300mm ²	XLPE/PILC/PICAS
SPAJ 12X 35-70-3	35-70mm ²	XLPE
SPAJ 12X 95-185-3	95-185mm ²	XLPE
SPAJ 12X 185-300-3	185-300mm ²	XLPE
SPAJ 12PX 35-70-3	35-70mm ²	Transition
SPAJ 12PX 95-185-3	95-185mm ²	Transition
SPAJ 12PX 185-300-3	185-300mm ²	Transition
SPAJ 12P 35-70-3	35-70mm ²	PILC/PICAS
SPAJ 12P 95-185-3	95-185mm ²	PILC/PICAS
SPAJ 12P 185-300-3	185-300mm ²	PILC/PICAS



Non Centralised Type Connectors



SPS Joint has tapered Profile with Conductors Centralised

Notes: Items 1-3 are the Universal type, items 4-12 have only the required modules. Trifurcating Joints are available.

Example: 3c 95mm² PILC to 3 x Single Core 95mm² XLPE = SPAJ 12PX-95-185-3-TRIF



3 Core XLPE Heat Shrink Joints 17.5 to 33kV

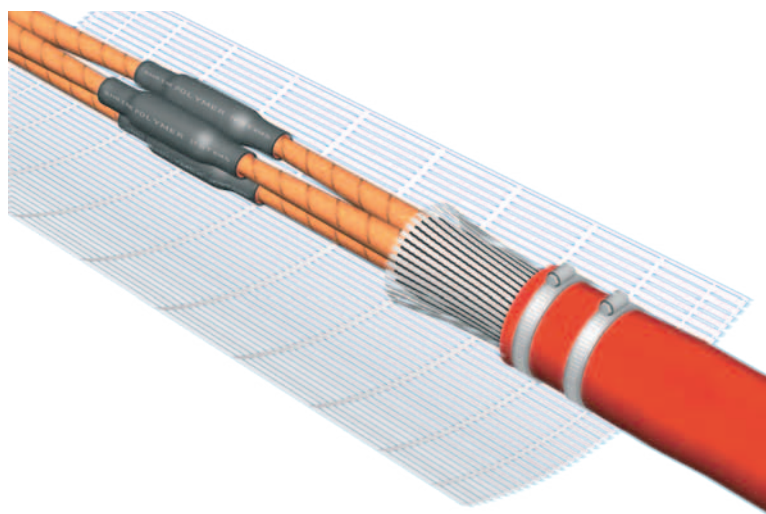

Three Core XLPE 17.5kV Joints

Part Number	Voltage	Cable Range
SPAJ 17.5X-16-35-3	17.5kV	16-35mm ²
SPAJ 17.5X-50-95-3	17.5kV	50-95mm ²
SPAJ 17.5X-120-185-3	17.5kV	120-185mm ²
SPAJ 17.5X-240-300-3	17.5kV	240-300mm ²

Three Core XLPE 24kV Joints

Part Number	Voltage	Cable Range
SPAJ 24X-16-35-3	24kV	16-35mm ²
SPAJ 24X-50-95-3	24kV	50-95mm ²
SPAJ 24X-120-185-3	24kV	120-185mm ²
SPAJ 24X-240-300-3	24kV	240-300mm ²

Three Core XLPE 33kV Joints

Part Number	Voltage	Cable Range
SPAJ 36X-35-95-3	33kV	35-95mm ²
SPAJ 36X-120-185-3	33kV	120-185mm ²
SPAJ 36X-240-300-3	33kV	240-300mm ²

Note: For trifurcating applications (3 core jointing to 3 x single core) add the letters “TRIF” in the part number.

Example: SPAJ 36X-120-185-3-TRIF



3 Core PILC Heat Shrink Joints 17.5 to 33kV

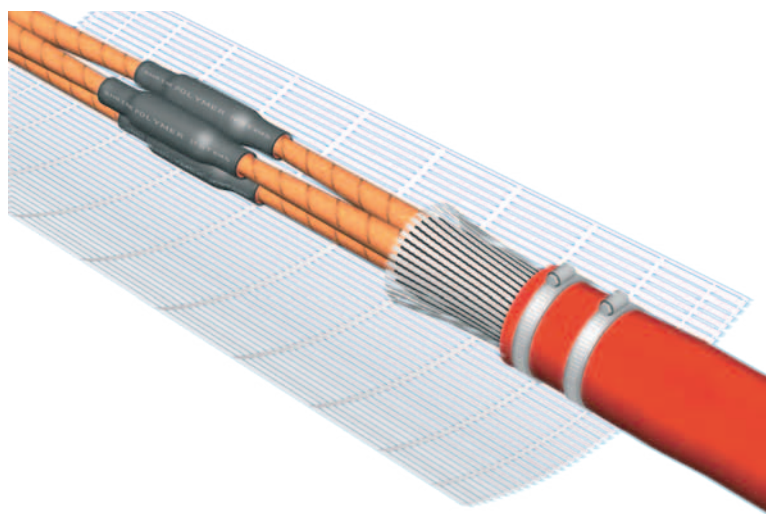

Three Core PILC 17.5kV Joints

Part Number	Voltage	Cable Range
SPAJ 17.5P-25-50-3	17.5kV	25-50mm ²
SPAJ 17.5P-70-95-3	17.5kV	70-95mm ²
SPAJ 17.5P-120-185-3	17.5kV	120-185mm ²
SPAJ 17.5P-240-400-3	17.5kV	240-400mm ²

Three Core PILC 24kV Joints

Part Number	Voltage	Cable Range
SPAJ 24P-25-35-3	24kV	25-35mm ²
SPAJ 24P-50-95-3	24kV	50-95mm ²
SPAJ 24P-120-185-3	24kV	120-185mm ²
SPAJ 24P-240-300-3	24kV	240-300mm ²

Three Core PILC 33kV Joints

Part Number	Voltage	Cable Range
SPAJ 36P-50-95-3	33kV	50-95mm ²
SPAJ 36P-120-185-3	33kV	120-185mm ²
SPAJ 36P-240-300-3	33kV	240-300mm ²

Note: For trifurcating applications (3 core jointing to 3 x single core) add the letters “TRIF” after part number.

Example: SPAJ 36P-120-185-3-TRIF



3 Core XLPE to PILC Transition Heat Shrink Joints 17.5 to 33kV

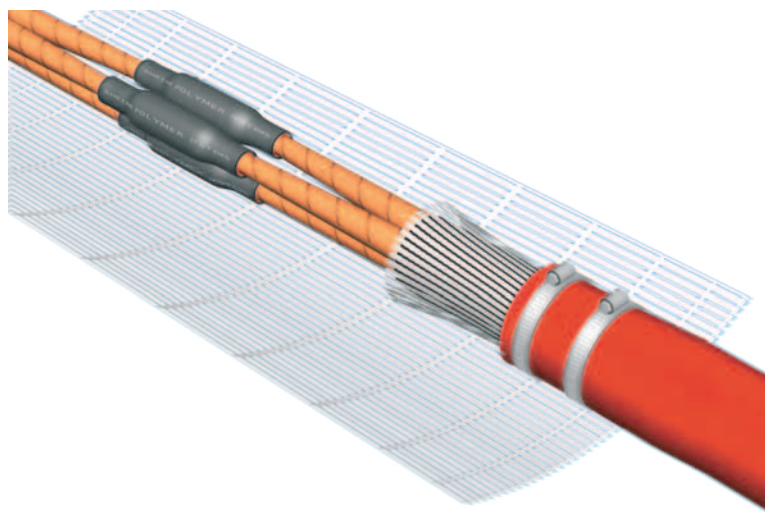

Three Core XLPE To PILC 17.5kV Joints

Part Number	Voltage	Cable Range
SPAJ 17.5PX-25-50-3	17.5kV	25-50mm ²
SPAJ 17.5PX-70-95-3	17.5kV	70-95mm ²
SPAJ 17.5PX-120-185-3	17.5kV	120-185mm ²
SPAJ 17.5PX-240-300-3	17.5kV	240-300mm ²

Three Core XLPE To PILC 24kV Joints

Part Number	Voltage	Cable Range
SPAJ 24PX-25-35-3	24kV	25-35mm ²
SPAJ 24PX-50-95-3	24kV	50-95mm ²
SPAJ 24PX-120-185-3	24kV	120-185mm ²
SPAJ 24PX-240-300-3	24kV	240-300mm ²

Three Core XLPE to PILC 33kV Joints

Part Number	Voltage	Cable Range
SPAJ 36PX-35-95-3	33kV	35-95mm ²
SPAJ 36PX-120-185-3	33kV	120-185mm ²
SPAJ 36PX-240-300-3	33kV	240-300mm ²

Note: For trifurcating applications (3 core jointing to 3 x single core) add the letters “TRIF” after part number.

Example: SPAJ 36PX-120-185-3-TRIF



Single Core Heat Shrink Joints 7.2 to 33kV

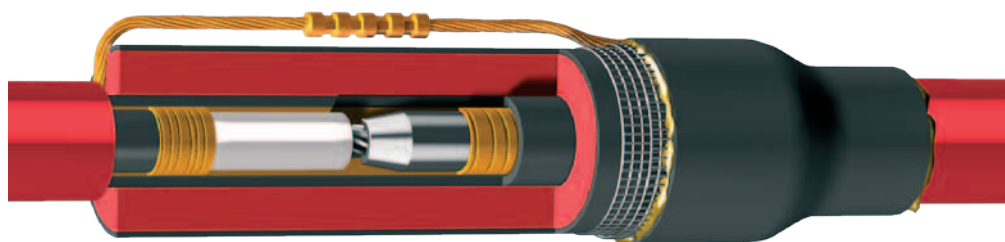

Single Core XLPE 7.2/12kV Joints

Part Number	Voltage	Cable Range
SPJ 12X-25-70-1	12kV	25-70mm ²
SPJ 12X-95-185-1	12kV	95-185mm ²
SPJ 12X-185-300-1	12kV	185-300mm ²
SPJ 12X-400-630-1	12kV	400-630mm ²
SPJ 12X-800-1	12kV	800mm ²

Single Core XLPE 17.5kV Joints

Part Number	Voltage	Cable Range
SPJ 17.5X-25-70-1	17.5kV	25-70mm ²
SPJ 17.5X-95-185-1	17.5kV	95-185mm ²
SPJ 17.5X-185-300-1	17.5kV	185-300mm ²
SPJ 17.5X-400-630-1	17.5kV	400-630mm ²
SPJ 17.5X-800-1	17.5kV	800mm ²

Single Core XLPE 24kV Joints

Part Number	Voltage	Cable Range
SPJ 24X-25-70-1	24kV	25-70mm ²
SPJ 24X-95-185-1	24kV	95-185mm ²
SPJ 24X-185-300-1	24kV	185-300mm ²
SPJ 24X-400-630-1	24kV	400-630mm ²
SPJ 24X-800-1	24kV	800mm ²

Single Core XLPE 33kV Joints

Part Number	Voltage	Cable Range
SPJ 36X-25-70-1	33kV	25-70mm ²
SPJ 36X-95-185-1	33kV	95-185mm ²
SPJ 36X-185-300-1	33kV	185-300mm ²
SPJ 36X-400-630-1	33kV	400-630mm ²

Notes: If cable is armoured (AWA), armour earth kit is supplied and part number becomes SPAJ. If long cable runs, cross bonding kits may be required, see page 29 for details.



Single Core Heat Shrink Joints 7.2 to 33kV

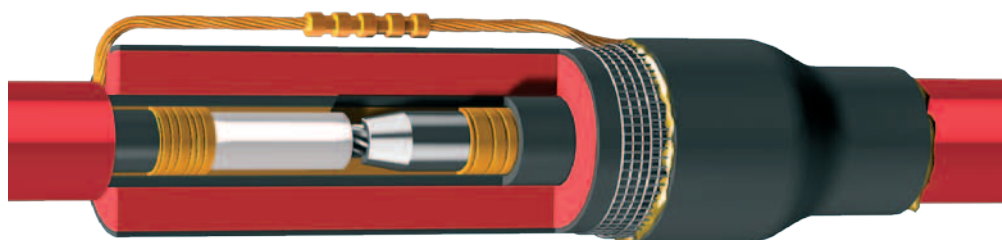

Single Core PILC 12kV Joints

Part Number	Voltage	Cable Range
SPJ 12P-50-95-1	12kV	50-95mm ²
SPJ 12P-120-185-1	12kV	120-185mm ²
SPJ 12P-240-400-1	12kV	240-400mm ²
SPJ 12P-500-630-1	12kV	500-630mm ²

Single Core PILC 33kV Joints

Part Number	Voltage	Cable Range
SPJ 36P-50-95-1	33kV	50-95mm ²
SPJ 36P-120-185-1	33kV	120-185mm ²
SPJ 36P-240-400-1	33kV	240-400mm ²
SPJ 36P-500-630-1	33kV	500-630mm ²

Single Core PILC to XLPE 12kV Joints

Part Number	Voltage	Cable Range
SPJ 12PX-50-95-1	12kV	50-95mm ²
SPJ 12PX-120-185-1	12kV	120-185mm ²
SPJ 12PX-240-400-1	12kV	240-400mm ²
SPJ 12PX-500-630-1	12kV	500-630mm ²

Single Core PILC to XLPE 33kV Joints

Part Number	Voltage	Cable Range
SPJ 36PX-50-95-1	33kV	50-95mm ²
SPJ 36PX-120-185-1	33kV	120-185mm ²
SPJ 36PX-240-400-1	33kV	240-400mm ²
SPJ 36PX-500-630-1	33kV	500-630mm ²

Notes: If cable is armoured (AWA), armour earth kit is supplied and part number becomes SPAJ. If long cable runs, cross bonding kits maybe required, see page 29 for details.



Earthing on Single Core Cables with Aluminium Wire Armours (AWA)

If single core aluminium wire armoured (AWA) cables are earthed only at one end, a voltage will appear at the other end. If both ends are earthed, circulating currents will be induced. How much will depend on a number of factors:

- Length of the cable run
- The current in the cable conductor and its frequency 50Hz or 60Hz
- The proximity of the other two cables, assuming a 3 phase system
- The mutual inductance per phase

The current can be calculated using the following method:

$$I_c = \left[\frac{V}{Z} \right] \text{ Amps}$$

Where
 I_c = Circulating current
 V = Induced voltage
 Z = Impedance of the sheath

On long cable runs potentially lethal over voltages can be induced and standard earthing methods do not provide adequate protection. A simple method to reduce or eliminate this effect is to divide the cable run into three equal sections and install cross bond kits. Kits are available from SPS.

Note: Installer would be well advised to obtain the parameters of the cable being installed from the cable manufacturer to enable values of induced voltage and current for a given situation.

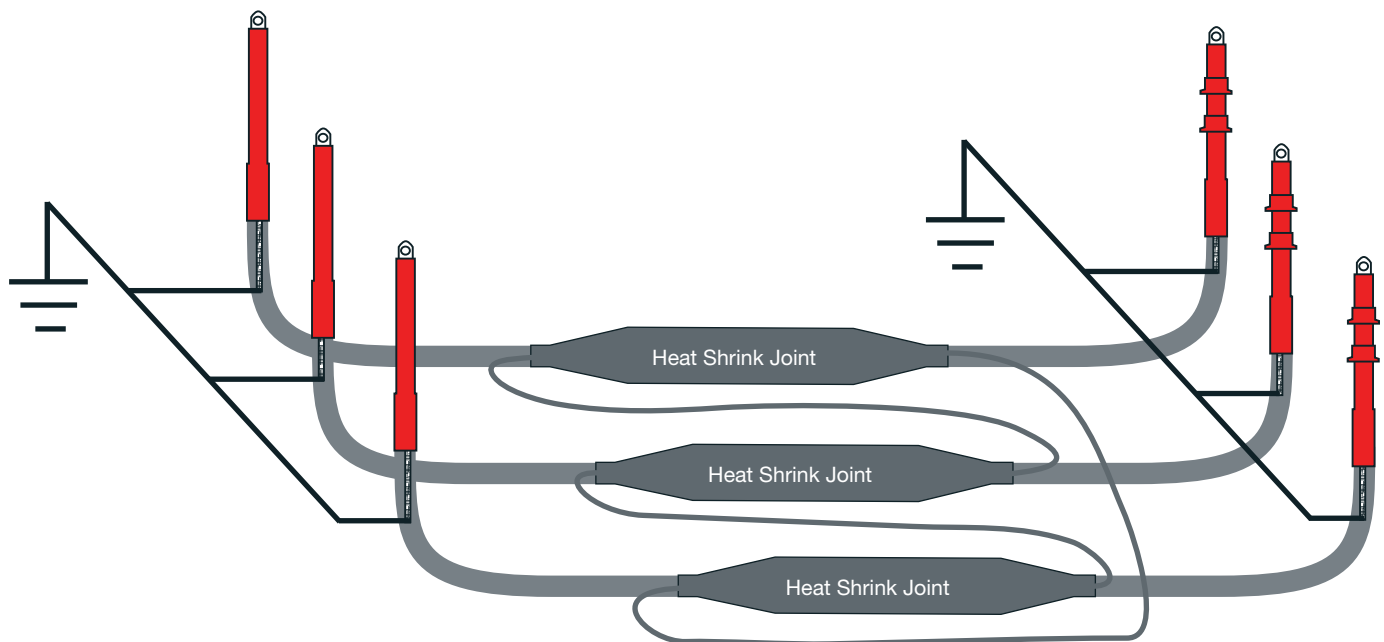

Typical Arrangement for Cross Bonding the Earth Straps to Alternate Phases



Live Pot End Kits to suit Single and 3 Core XLPE and Paper Cables 7.2-33kV Cables

Pot End Kits

Occasionally medium voltage cable circuits need to be installed and energised in the ground but not immediately used to connect to transformers or switchgear. This maybe done at a later stage when perhaps an extension to a building/factory is undertaken and the previously installed cable circuits, can then be utilised.

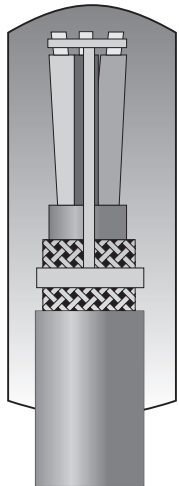
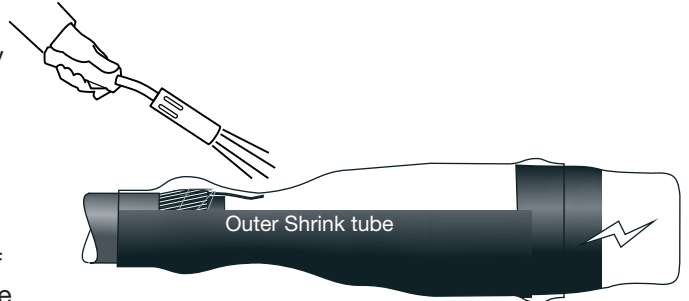

A live pot end kit is a reliable method of terminating a cable which will be left live. An extensive range of kits are available, see the selection chart below.

Abandonment Kits

If cables are left in the ground and must be sealed but not energised, abandonment kits can be supplied. From the outside they look similar to live pot end kits but internally, the phases are connected to earth so that if voltage is applied to the cables by mistake, an immediate earth fault occurs, tripping out the circuit breaker.

Pot End and Abandonment Kit Selection Chart

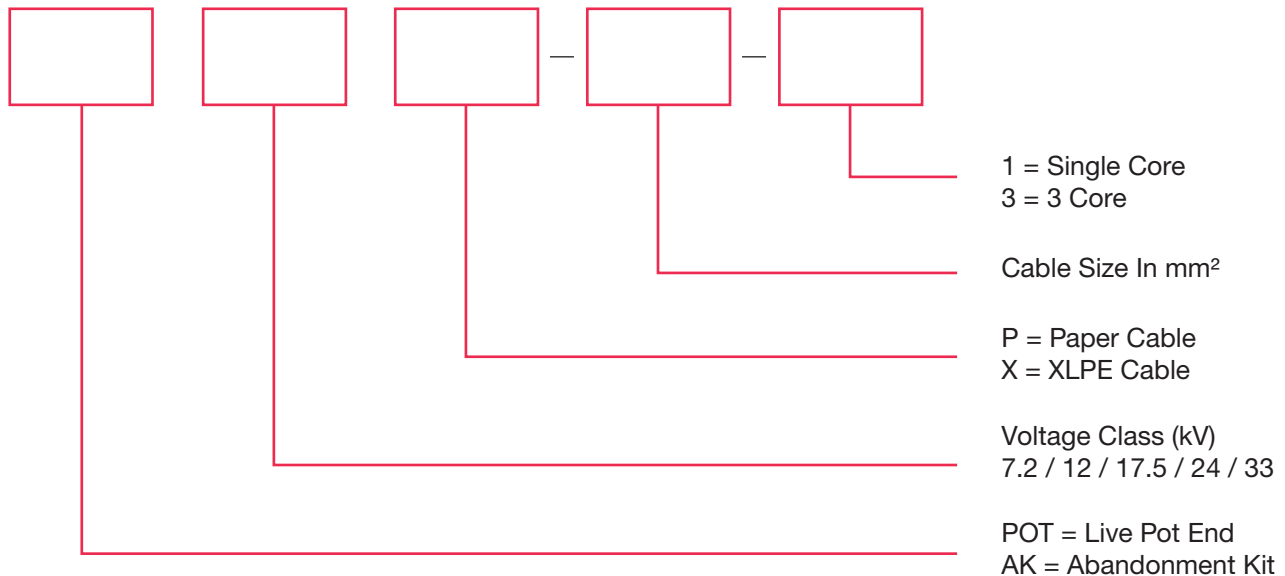

Example:

Cable = 3 Core 95mm² 33kV XLPE / SWA / PVC

Live Pot End Kit = POT 36X-95-3

Abandonment Kit = AK 36X-95-3



Cold Shrink Joints to suit Single and 3 Core XLPE and EPR 7.2-33kV Cables

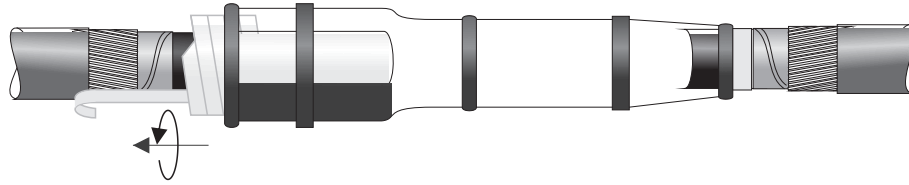

Where installations are sensitive to the application of a naked flame, or if a more simple joint system is required that is easier and quicker to install, cold shrink type joints can then offer benefits compared to heat shrink systems.

Shrink Polymer Systems can offer a wide range of high performance silicone cold shrink joints for XLPE / EPR medium voltage single and 3 core cables for voltage classes up to 33kV.

At the heart of the joint, is the one piece silicone body incorporating both stress control, insulating and conductive layers. After application of the earth screening, the user has the choice of utilising a shell and resin to provide the outer environmental protection, or if he prefers, combine the benefits of the easy to fit cold shrink joint body, along with a thick wall adhesive lined shrink tube, to provide outer protection. The latter allowing installations that can be completed in the horizontal and vertical planes as well as reducing the installation time/cost.

Fully tested to international standards, the range is extensive and the selection chart below can be used to determine the correct joint system.

Cold Shrink Joint Kit Selection Chart

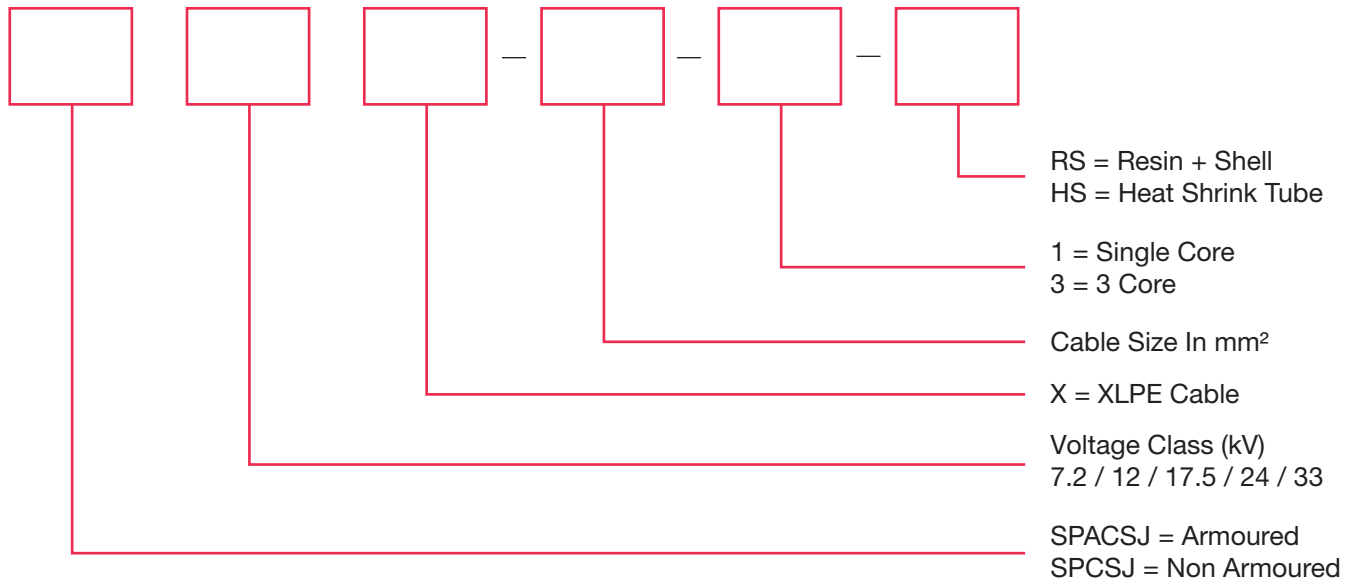

Example:

Cable = 3 Core 95mm² 33kV XLPE / SWA / PVC

Joint Kit With Heat Shrink Tube = SPACSJ 36X-95-3-HS

Notes: Single core joints are available with resin and shell or heat shrink tube for all voltage classes.
3 core joints available with resin and shell up to 12kV and thereafter with heat shrink tube.
If long cable runs, cross bonding kits maybe required, see page 29 for details

Medium Voltage Busbar Tube

- Substantially improves clearance dimensions within installations
- Highly flexible for use on straight or angled bars
- Available on spools for reduced waste

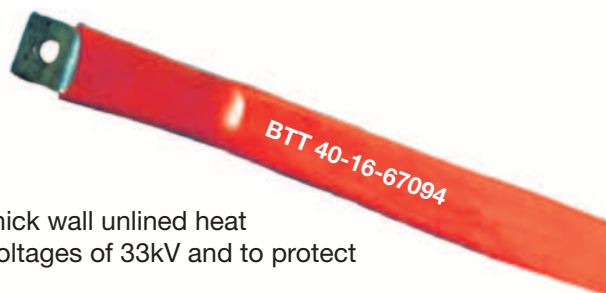

Shrink Polymer Systems BMT and BTT are red medium and thick wall unlined heat shrinkable tubes designed to insulate busbar systems up to voltages of 33kV and to protect against flashover.

The insulation value of both medium wall (BMT) and thick wall (BTT) allows substantial reductions in Ph-Ph and Ph-E clearances compared with air insulated systems.

Busbar Tube Size Selection

For guidance only, the user should always determine the optimum size. The maximum wall thickness ('T') shown, is only achieved as a result of full recovery in air. The actual wall thickness will vary depending on the size of the busbar profile.

Exp Dia	Rec Dia	'T'	W = Laid Flat Width 'W' (mm)	Rectangular Busbar 'X' = (a+b) mm	'D'
		Max Recovered Wall Thickness 'T' (mm)			Round Busbar Dia 'D' (mm)
Medium Wall Busbar Tube Spool Size 15mtr					
Exp/ Rec	Rec 'T' (mm)	Exp 'W' (mm)	'X' Range (mm)	'D' Range (mm)	
BMT 30/12	2.0	47	35-22	25-14	
BMT 35/14	2.0	55	38-25	28-16	
BMT 40/16	2.0	63	42-28	32-18	
BMT 50/20	2.0	78	60-35	40-22	
BMT 65/25	2.0	102	85-44	55-27	
BMT 75/30	2.0	117	94-52	60-32	
BMT 100/40	2.0	157	125-70	80-42	
Thick Wall Busbar Tube Spool Size 15mtr					
Exp/ Rec	Rec 'T' (mm)	Exp 'W' (mm)	'X' Range (mm)	'D' Range (mm)	
BTT 30/12	2.3	47	30-22	25-14	
BTT 40/16	2.5	63	42-28	32-18	
BTT 50/20	2.5	78	60-35	40-23	
BTT 65/25	2.5	102	85-44	55-28	
BTT 75/30	2.6	117	94-52	60-33	
BTT 85/35	2.6	133	105-60	70-38	
BTT 100/40	2.8	157	120-70	80-44	
BTT 120/50	3.0	188	140-85	100-55	
BTT 150/60	3.5	235	160-100	120-65	



Typical Clearances of Busbars with BMT and BTT

The following table indicates possible clearance reductions as a result of using BMT or BTT to insulate busbars compared with un-insulated bars in air.

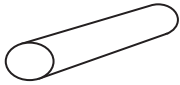
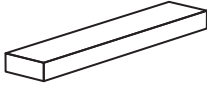
Rated Voltage (kV)	BMT Medium Wall Busbar Tube		BMT Medium Wall Busbar Tube		Un-Insulated Busbars
	Ph-E (mm)	Ph-Ph (mm)	Ph-E (mm)	Ph-Ph (mm)	IEC 71-2 Ph-E In Air (mm)
	Round Profile 		Rectangular Profile 		Un-Insulated Busbars
12	60	50	70	60	120
17.5	80	65	100	80	160
24	120	90	145	110	220
36	200	145	280	190	320

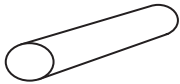
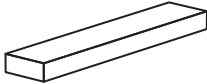
Rated Voltage (kV)	BTT Thick Wall Busbar Tube		BTT Thick Wall Busbar Tube		Un-Insulated Busbars
	Ph-E (mm)	Ph-Ph (mm)	Ph-E (mm)	Ph-Ph (mm)	IEC 71-2 Ph-E In Air (mm)
	Round Profile 		Rectangular Profile 		Un-Insulated Busbars
12	40	30	45	35	120
17.5	60	45	65	55	160
24	90	60	100	70	220
36	160	100	190	140	320

BMT and BTT Technical Data	Performance	Test Method
Continuous Operating Temperature	-40 to +125°C	IEC 216
Shrink Temperature	110°C	IEC 216
Cold Bend -40°C for 4hrs	No Damage	ASTM D2671
Flammability (Oxygen Index)	>25	ASTM 4589
Tensile Strength	>11.8 Mpa	ASTM D638
Tensile Strength After Aging 120°C 168hrs	>10MPa	ASTM D2671
Elongation at Break	> 700%	ASTM D638
Elongation at Break After Aging 120°C 168hrs	> 500%	ASTM D2671
Water Absorbition 23°C 14 days	< 0.5%	ISO 32
Copper Corrosion 120°C 168hrs	No Corrosion	ASTM D2671
Dielectric Strength	> 20kV/m m	IEC 243
Dielectric Constant	max 3.0	IEC 250
Volume Resistivity	1x10 ¹³ Ohms /cm	IEC 93
Mould Resistance	No Growth	ASTM G21-D638
Heat Dissipation	Current Rating Not Effected by Tubing	

Criteria Influencing Electrical Performance

1. Insulation wall thickness
2. Available Ph-Ph and Ph-Earth clearance
3. Busbar chamber geometric configuration
4. Busbar profile



Medium Voltage Busbar Tube

- Substantially improves clearance dimensions within switchgear installations
- Flexible for use on straight or angled bars
- Available on spools to reduce waste

Shrink Polymer Systems BTMC and BTMI are medium and thick wall black unlined heat shrink tubes designed to insulate 12kV busbar systems and to protect against flashover.

The insulation value of both medium wall (BTMC) and thick wall (BTMI) enable substantial reductions in Ph-Ph and Ph-E clearances compared with air insulated systems.

Table 1 is for guidance only, the user should always determine the optimum size. The maximum wall thickness ('T') shown, is only achieved as a result of full recovery in air. The actual wall thickness will vary depending on the size of the busbar profile.

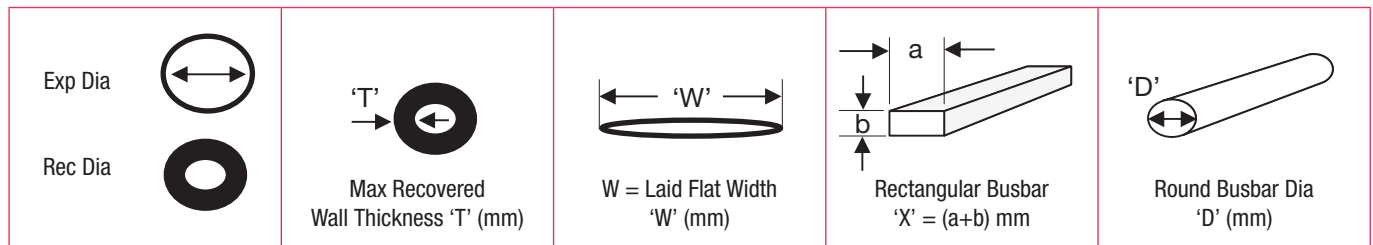

Medium Wall Busbar Tube Spool Size 30mtr

Exp/ Rec	Rec 'T' (mm)	Exp 'W' (mm)	'X' Range (mm)	'D' Range (mm)
BTMC 22/6	2.2	39	35-20	20-10
BTMC 33/8	2.5	53	50-25	30-12
BTMC 40/12	2.5	63	60-30	35-14
BTMC 55/16	2.7	85	80-35	50-20
BTMC 75/22	3.0	110	100-40	65-27
BTMC 95/25	3.0	141	130-60	85-32
BTMC 115/34	3.0	192	180-75	98-42
BTMC 160/50	3.0	267	250-90	148-65

Thick Wall Busbar Tube Spool Size 30mtr

Exp/ Rec	Rec 'T' (mm)	Exp 'W' (mm)	'X' Range (mm)	'D' Range (mm)
BTMI 22/6	2.7	31	25-15	15-8
BTMI 33/8	3.2	47	42-20	26-10
BTMI 45/12	4.1	63	60-30	35-14
BTMI 55/16	4.1	83	80-32	48-18
BTMI 75/22	4.1	110	100-38	65-27
BTMI 95/30	4.3	146	130-60	86-32
BTMI 130/36	4.3	192	180-75	117-42



Anti-Track Busbar Insulation Tape

- Reduces busbar clearance dimensions
- Protects against accidental flash over
- Adhesive coated
- Easy to apply
- Ideal for tee sections on busbar installations

Shrink Polymer Systems product type SPBT is a cross linked polyolefin anti-track busbar insulation tape designed for use in medium voltage busbar insulation applications.

Available in three widths and coated with an anti-track sealant, it is ideal for use in restricted access areas and an ideal partner to our range of medium and thick wall heat shrinkable busbar insulation tubings types BMT and BTT.

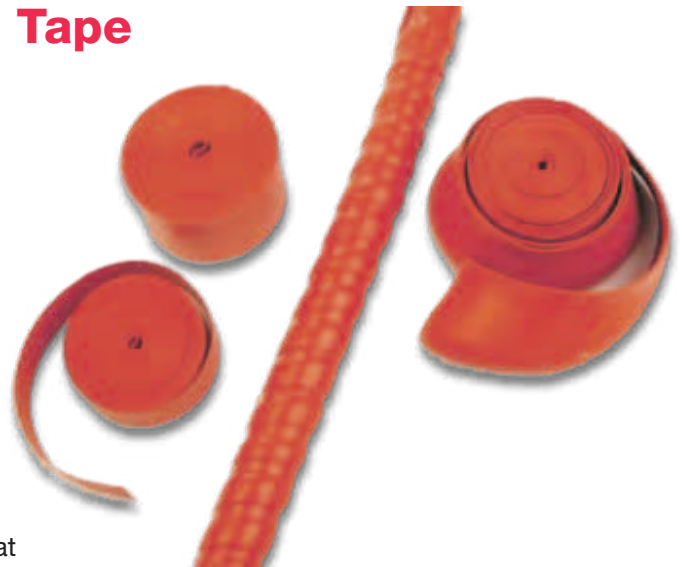

Part Number	Width	Roll Length
SPBT 25	25mm	10mtr
SPBT 50	50mm	10mtr
SPBT 100	100mm	10mtr

Physical Properties

Tensile Strength	ASTM D2671	> 11.8 Mpa
Elongation	ASTM D2671	> 550%
Heat Shock (4hrs at 225°C)	ASTM D2671	No cracking or flowing
Low Temperature Flexibility 4hrs at -40°C	ASTM D2671	No cracking
Flammability	ASTM D2671	Pass

Electrical Properties

Dielectric Strength	IEC 243	20kV/mm
Surface Resistance	ASTM D257	510 x 10 ⁹ ohm
Volume Resistivity	IEC 93	> 10 to power of 13 ohm.cm
Dielectric Constant	IEC 250	< 3.5
Tracking Tests	ANSI C37.20	Non-tracking
Weathering	ASTM G53	Non tracking after 3 hrs

Adhesive Properties

Adhesive softening point	ASTM E-281	100°C
Low Temp Flexibility	STM C12	-25°C
Tracking Tests	ANSI C37.20. ASTM D2303	Non-Tracking



Medium Voltage Termination Components

Anti-Track Heat Shrink Tubing

Shrink Polymer Systems type AT anti-track tube is used primarily for insulation on medium voltage power cable termination systems up to 36kV.

Available in seven different sizes with shrink ratios of 3 to 1, all cable sizes are catered for in each voltage class.

Additionally AT anti-track is self extinguishing and is inherently LSF, therefore it can be used where fire sensitive installations are required.



Part Number	Expanded Dia (mm)	Recovered Dia (mm)	Wall Thickness (mm)	Reel Size
AT 30/10	30	10	2.80	15mtr
AT 35/12	35	12	2.80	15mtr
AT 45/18	45	18	3.00	15mtr
AT 54/24	54	24	3.00	15mtr
AT 60/29	60	29	3.00	15mtr
AT 76/38	76	38	3.00	15mtr
AT 100/49	100	49	3.00	15mtr



Anti-Track Mastic Sealant Tape

Shrink Polymer Systems A100 product is a red mastic melt tape sealant with anti-track properties. It is mainly used for sealing purposes within medium voltage terminations but can easily be utilised as an additional seal in other low and medium voltage applications.

A100 is 25mm wide, 0.8mm thick and comes as standard in 300mm lengths although other lengths are available.

Anti-Track Rain Sheds

Rain sheds are used to increase the creepage length on medium voltage terminations. Four sizes are generally available.

Part Number	D (mm)	Dia (d) Exp (mm)	Dia (d) Rec (mm)	C (mm)
ARS 35/12	95	35	12	18
ARS 60/20	120	60	20	21
ARS 75/30	140	75	30	25
ARS 120/45	200	120	45	35

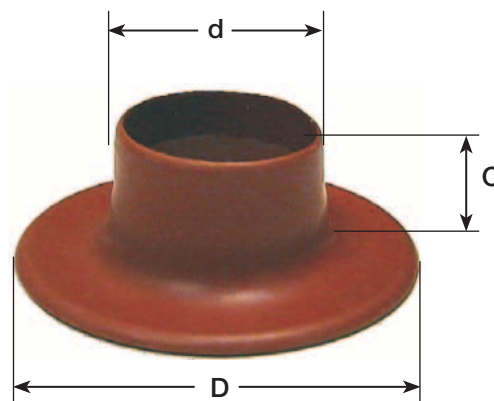

Medium Voltage Termination and Joint Components

Medium Voltage Breakout Boots

Shrink Polymer Systems offer two different types of heat shrink medium voltage breakout boot. One is produced from anti-track material making it suitable for polymeric terminations up to 33kV.

The other is manufactured from a semi-conductive compound and is suitable for both polymeric and paper insulated terminations up to 33kV.

Where a cable incorporates additional cores, eg extra signal or fibre optic cores please advise as specials can be accommodated.

Semi-Conductive						
Part Number	Legs	Type	Skirt Dia. (mm)		Leg Dia. (mm)	
			Exp	Rec	Exp	Rec
SCB 60/24	3	SEMI-CON	60	24	25	8
SCB 80/38	3	SEMI-CON	80	38	35	11
SCB 110/50	3	SEMI-CON	110	50	46	18
SCB 125/57	3	SEMI-CON	125	57	55	20

A more detailed specification is available upon request.

Anti-Track						
Part Number	Legs	Type	Skirt Dia. (mm)		Leg Dia. (mm)	
			Exp	Rec	Exp	Rec
ATB 60/24	3	ANTI-TRACK	60	24	25	8
ATB 80/38	3	ANTI-TRACK	80	38	35	11
ATB 110/50	3	ANTI-TRACK	110	50	46	18
ATB 125/57	3	ANTI-TRACK	125	57	55	20

A more detailed specification is available upon request.



**Semi Conductive
Breakout Boot**



**Anti-Track
Breakout Boot**



Medium Voltage Termination and Joint Components

TS 31785Y HV Stress Control Tape

Shrink Polymer Systems TS 31785Y is a high permittivity yellow butyl stress relief tape that is used within heat shrinkable joint and termination systems up to voltages of 33kV.

The tape is ideally suited to both paper and polymeric insulated cables and is used over the connector area and at end of screen points.

TS 31785Y used in conjunction with heat shrink tubing has a flow/void filling characteristic and adheres well to most surfaces.

As standard TS 31785Y is supplied in widths of 25mm x 10mtr rolls. Other lengths are available upon request.

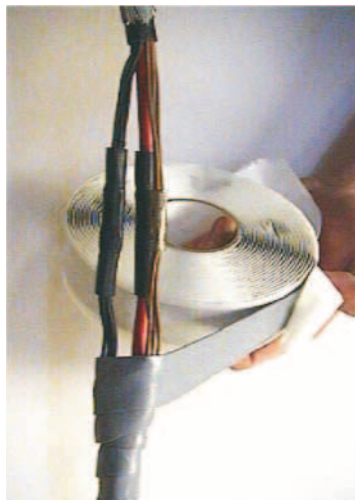

4SC HV Stress Control Tape

Shrink Polymer Systems 4SC HV stress tape is a special cross linked grey butyl tape suitable for continuous operation between -40 to +130°C.

The sealant is a soft, tacky, pliable material with the ability to ‘wet out’ to a wide variety of rubbers, plastics and metals.

4SC HV can be used as a filler to smooth out sharp or sudden transitions or configurations in high voltage stress areas within electric cables. The tape will also provide a moisture proof seal when used with heatshrink tubing.

4SC HV is 25mm in width, 3mm thick and available on 7.6 mtr (25ft) rolls or in strips cut to length.

Black Melt Void Filling Tape

Shrink Polymer Systems tape type 212D is a black mastic tape that is used within joint kits to provide an effective internal moisture seal. When heat is applied to the joint, the tape melts and flows within, filling any voids. The tape is also used within a number of submersible heat shrink joint kits supplied to various offshore oil companies.

212D is generally supplied as follows:

Length	300mm
Width	50mm
Thickness	2mm

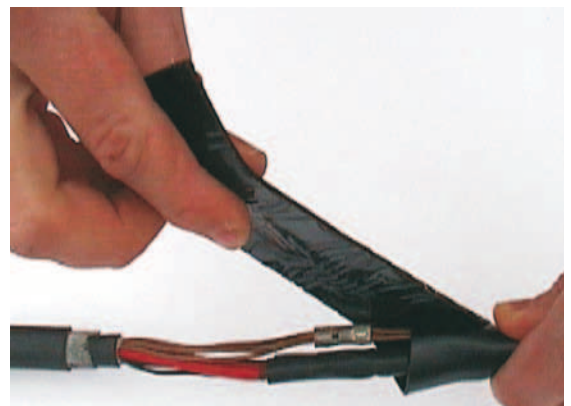



Stainless Steel Roll Springs

Roll springs provide a reliable method of solderless earthing in low and medium voltage heat shrink joint and termination systems.

The springs listed below are all standard stock items. We are happy to quote you for any alternative if full details are provided.

Part Number (mm)	Inner Dia (mm)	Width	Length (mm)	Application Range (mm)
CF1	7.39	9.50	200	9-12
CF2	9.22	12.70	250	12-16
CF3	15.5	15.90	216	16-23
CF4	18.47	15.90	400	22-30
CF5	22.17	19.00	400	28-38
CF6	25.91	25.40	711	36-42
CF7	35.05	25.40	610	42-56
CF8	44.00	20.00	935	54-80



Earthing Components

A wide range of copper earth straps/socks are available from stock and can be cut to the required length. Solder blocks can be applied and braids can be insulated with heat shrink sleeving if desired.

Part Number	Description	Unit of Measure
FLT B 7.5	Flat Tinned Copper Earth Strap 7.5mm ² CSA	mtr
FLT B 16	Flat Tinned Copper Earth Strap 16mm ² CSA	mtr
FLT B 25	Flat Tinned Copper Earth Strap 25mm ² CSA	mtr
TCB 12.5	Tubular Tinned Copper Earth Sock 7.5mm ² CSA	mtr
TCB 25	Tubular Copper Earth Sock 25mm ID BY 16mm ² CSA	mtr
TCB 50	Tubular Copper Earth Sock 50mm ID BY 25mm ² CSA	mtr
KM 50	Tinned Copper Screening Bandage 50mm Width	5mtr





2A

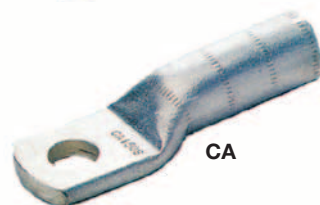

CA



MT

MV Copper Crimp Lugs and Ferrules

- Suitable for use up to 19/33kV
- The absence of an inspection hole makes both type 2A and CA suitable for outdoor use
- Type 2A has extended lug barrel for heavy duty use
- Good cost savings on the 2A range
- Compatible with the majority of tooling on the market today

Series CA-M, 2A-M terminal lugs and MT ferrules are designed for use for applications up to 33kV.

They are manufactured from high purity copper tube, annealed and tin plated.

A full range of tooling is available upon request and confirmation can be provided as to the compatibility of using existing tooling by calling Shrink Polymer Systems.

Conductor Size (mm ²)	Part Number CA Range	Part Number 2A Range	Part Number Ferrule	Part Number Ferrule (Blocked)
16	–	2A3-M –	–	–
25	CA 25-M –	2A5-M –	MT 25TD	MT 25GC
35	CA 40S-M –	2A7-M –	MT 40S-TD	MT 40S-GC
50	CA 50S-M –	2A10-M –	MT 50S-TD	MT 50S-GC
70	CA 70S-M –	2A14-M –	MT 70S-TD	MT 70S-GC
95	CA 95S-M –	2A19-M –	MT 95S-TD	MT 95S-GC
120	CA 150R-M –	2A24-M –	MT 150R-TD	MT 150R-GC
150	CA 150S-M –	2A30-M –	MT 150S-TD	MT 150S-GC
185	CA 200R-M –	2A37-M –	MT 200R-TD	MT 200R-GC
240	CA 315R-M –	2A48-M –	MT 315R-TD	MT 315R-GC
300	CA 315S-M –	2A60-M –	MT 315S-TD	MT 315S-TD
400	2A80-M –	2A80-M –	MT 400-TD	MT 400-GC
500	2A100-M –	2A100-M –	MT 500-TD	MT 500-GC
630	2A120-M –	2A120-M –	MT 630-TD	MT 630-GC
800	2A160-M –	2A160-M –	–	–
1000	2A200-M –	2A200-M –	–	–

Specify stud fixing on lugs i.e. 95mm² type 2A lug M10 stud would be part number 2A19-M10



MV Aluminium Crimp Lugs and Ferrules

- Suitable for use up to 33kV
- The absence of an inspection hole makes both AA and CAA lugs suitable for outdoor use
- Compatible with the majority of tooling on the market today

Series AA aluminium lugs, CAA bi-metal crimp lugs and MTMA ferrules are designed for use up to 33kV.

They are manufactured from high purity aluminium of a purity greater than 99.5%. The barrels are capped and filled with grease to avoid oxidation of the aluminium.

A full range of tooling is available upon request and confirmation can be provided as to the compatibility of using existing tooling by calling Shrink Polymer Systems.

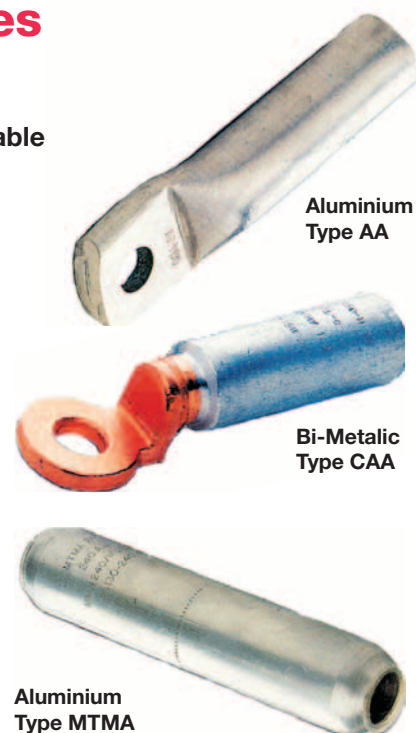

Conductor Size (mm ²)	Part Number AA Range	Part Number CAA Range	Part Number Ferrule	Part Number Ferrule (Blocked)
16	AA 16-M	CAA 16-M	MTMA 16-1	MTMA 16-GC
25	AA 25-M	CAA 25-M	MTMA 25-1	MTMA 25-GC
35	AA 35-M	CAA 35-M	MTMA 35-1	MTMA 35-GC
50	AA 50-M	CAA 50-M	MTMA 50-1	MTMA 50-GC
70	AA 70-M	CAA 70-M	MTMA 70-1	MTMA 70-GC
95	AA 95-M	CAA 95-M	MTMA 95-1	MTMA 95-GC
120	AA 120-M	CAA 120-M	MTMA 120-1	MTMA 120-GC
150	AA 150-M	CAA 150-M	MTMA 150-1	MTMA 150-GC
185	AA 185-M	CAA 185-M	MTMA 185-1	MTMA 185-GC
240	AA 240-M	CAA 240-M	MTMA 240-1	MTMA 240-GC
300	AA 300-M	CAA 300-M	MTMA 300-1	MTMA 300-GC
400	–	–	MTMA 400-1	MTMA 400-GC
500	–	–	MTMA 500-1	MTMA 500-GC
630	–	–	–	–

Specify stud fixing on lugs i.e. 95mm² type CAA lug M12 stud would be part number CAA95-M12



MV Mechanical Shearbolt Terminal Lugs and Ferrules









- Range finding and suitable for copper and aluminium conductors
- Tapered enabling centralised conductors making them suitable for use up to 19/33kV
- No special tooling required or calibration

Shrink Polymer Systems offers a range of high quality mechanical shearbolt lugs and ferrules for use on medium voltage cables to 33kV.

Multiple shear head bolts with defined torque guarantees, ensure the necessary contact pressure and tensile strength of the connectors. The range has successfully passed tests to IEC 1238-1 and have been tested with our own medium voltage joints to BS 7888 and Cenelec 628 S1 and 629.1 S1.



Size	Usage of Concentric Sleeves for Conductor Types DIN VDE 0295							
	Sleeve	 (comp.)			 90°	 120°	 90°	 120°
1	blue	25-35	25	25-35				
	yellow	50-70	35-50	50-70	35	35	50	
	–	95	70	95	50-95(r)	50-70(*)	70-95(*)	50-95(r)
2	blue	50-70	50	50-70			50	
	yellow	95-120	70-95	95-120	50-70	50-70	70-95	50-70
	–	150	120	150	95-150(r)	95(*)-120(r)	120-150(r)	95-150(r)
3	blue	70-95	70	70-95	70		70	70
	yellow	120	95	120		70	95	
	red	150-185	120-150	150-185	95-120	95	120-150	95-120
	–	240	185	240	150-185(*)	120-185(r)	185-240(r)	150-185(*)
4	blue	120		120				
	yellow	150-185	120-150	150-185	120		120-150	120
	red	240	185	240	150	120	185	150
	–	300	240-300	300	185-300(r)	150-240(r)	240	185-240
5	blue	95		95				
	yellow	120-185	95-150	120-185	95-120	95	95-150	95-120
	red	240-300	185-240	240-300	150-185	120-150	185	150-185
	–	400	300-400	400	240-300	185-300(r)	240	240
6	blue	300		300				
	yellow	400	300	400				
	red	500	400	500	300			
	–	630	500-630	630	400	300-400(*)		

Key: (comp.) = compacted conductor (r) = rounded conductor (*) = slight rounding of conductor, e.g. with flat nose pliers

To select Terminal Lug, use code: MVML, add size 1-6, then state stud size

Example: Conductor size = 185mm² circular stranded and you require M12 stud = MVML 3-M12

To select Through Connector, use code: MVMC, add size

Example: Conductor size = 240mm² sector stranded = MVMC 5



MV Cable Preparation Tools

One of the main factors in termination and joint failure is the poor removal of the semi-conductive screen on polymeric cables. Easy strip screens are quite straightforward and can be removed utilising the methods featured on our website in conjunction with the TT 2532 tool below.

However, with bonded screens, Shrink Polymer Systems can offer a wide variety of tools from several different manufacturers to assist in this essential task. However, we prefer to offer the limited range below because in our opinion, they work well, are good quality and are reasonably priced.

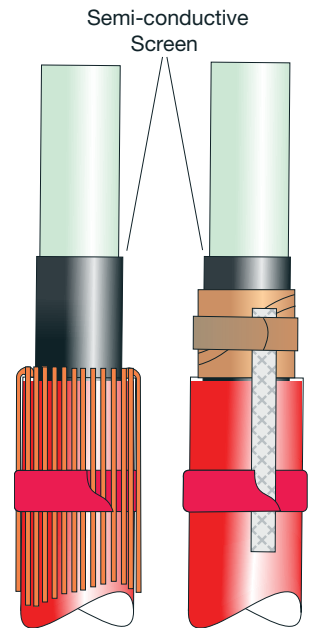

The TT 2532 scoring tools are intended for use with polymeric cables that have 'strippable' semi-conductive screen layers.

These tools have pre-set blades, ensuring no damage can be caused to the underlying primary insulation.

Part Number	Blade Depth
TT 2532-1	0.4mm
TT 2532-2	0.6mm

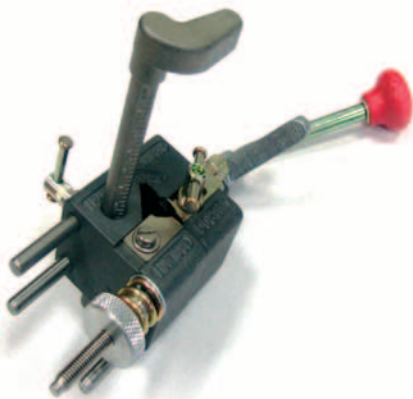

The BRM RD1 is a tool designed to remove the core insulation from polymeric cables.

The tool is fully adjustable and removes the insulation with a spiral cut protecting the conductors from accidental damage.

Part Number	Cable O/D
BRM-RD1	14-40

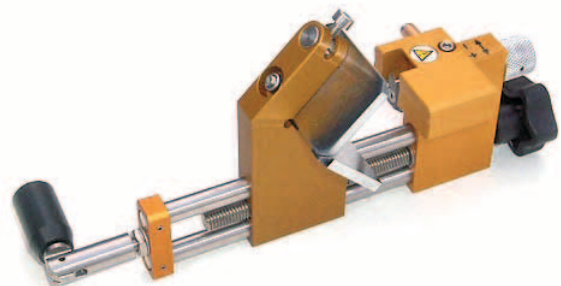

The GB-P20 is intended for use with the removal of bonded type semi-conductive screen layers.

The tool is fully adjustable and shaves the screen layer off in a spiral pattern with minimum damage to the primary insulation below.

Part Number	Cable O/D	Spare Blade
GB-P20	10-50	GB-P20-S6



Heat Shrink Joints to Suit Low Voltage Cables Type XLPE/SWA/PVC 0.6/3.3kV



- Meets the jointing requirements of BS6910 part 1, test report available
- Unlimited shelf life
- Slim profile, can be mounted vertically
- Allows for immediate backfill
- Zero halogen, fire resistant and non armoured types are also available

Shrink Polymer Systems heat shrink joint kits are intended for use with PVC and XLPE non screened cables for voltages up to 3.3kV.

The system comprises of adhesive lined connector insulation tubes, heavy duty armour cage (copper mesh on the smallest joints), armour support rings, armour clamps and an outer thick wall adhesive lined heat shrink tube.

Single core joints contain a heavy duty aluminium cage if the cable has aluminium wire armours.

Many thousands of our joints are installed worldwide including critical locations such as Ministry of Defence, Department of Transport, petro chemical sites and Network Rail / London Underground installations.

Heat Shrink Joints To Suit Single Core XLPE/AWA/PVC

Part Number	Cable Range	Voltage
SPA 50-95-1	50-95mm ²	0.6/3.3kV
SPA 120-185-1	120-185mm ²	0.6/3.3kV
SPA 240-300-1	240-300mm ²	0.6/3.3kV
SPA 400-630-1	400-630mm ²	0.6/3.3kV

Heat Shrink Joints to Suit XLPE/SWA/PVC

Part Number	Cable Range	Voltage
SPA 1.5-2.5 –	1.5-2.5mm ²	600/1000V
SPA 4-6 –	4-6mm ²	600/1000V
SPA 10-16 –	10-16mm ²	600/1000V
SPA 25-50 –	25-50mm ²	0.6/3.3kV
SPA 70-95 –	70-95mm ²	0.6/3.3kV
SPA 120-185 –	120-185mm ²	0.6/3.3kV
SPA 240-300 –	240-300mm ²	0.6/3.3kV

Note: To denote number of cores, add number to end of reference.

Example: 12 core 2.5mm² = SPA 1.5-2.5-12

For non armoured cables, delete the letter A, for shipwiring cables, add letters SW after SPA, for hydrocarbon resistant joints add letters HC after SPA



Heat Shrink Joints to Suit Low Voltage Cables Type PILC/SWA/PVC 0.6/3.3kV

- Meets the jointing requirements of BS6910 part 1, test report available
- Unlimited shelf life
- Slim profile, can be mounted vertically
- Allows for immediate backfill
- Zero halogen, fire resistant and non armoured types are also available



A range of joints are also available for jointing both PILC to XLPE transition and PILC to PILC cables.

These joints offer the same benefits and comprise of similar components to those in the polymeric range, with the addition of breakout boots, core tubes and earthing for the lead sheath on paper cables.

Heat Shrink Joints 3 Core PILC to PILC

Part Number	Cable Range	Voltage
SPAP 16-35-3	16-35mm ²	600/1000V
SPAP 50-95-3	50-95mm ²	600/1000V
SPAP 120-150-3	120-150mm ²	600/1000V

Heat Shrink Joints 4 Core PILC to PILC

Part Number	Cable Range	Voltage
SPAP 16-35-4	16 -35mm ²	600/1000V
SPAP 50-95-4	50 -95mm ²	600/1000V
SPAP 120-150-4	120 -150mm ²	600/1000V
SPAP 185-300-4	185 -300mm ²	600/1000V

Heat Shrink Transition Joints 4 Core PILC to XLPE

Part Number	Cable Range	Voltage
SPAPX 16-35-4	16 -35mm ²	600/1000V
SPAPX 50-95-4	50 -95mm ²	600/1000V
SPAPX 120-185-4	120 -185mm ²	600/1000V
SPAPX 185-300-4	185 -300mm ²	600/1000V

Low Voltage Zero Halogen Cable Joints for limited Fire Hazard Cables



- Fire tested and compliant with London Underground standards 2-0100-002 or the fire safety of materials and E4156 for the cable standard
- Slim profile and unlimited shelf life complete with range taking mechanical shearbolt connectors if required
- Full range of joints available for all cable types including power and multicore cables

Shrink Polymer Systems offer a comprehensive range of heat shrink joints suitable for both single and multicore low smoke fume zero halogen cables.

Developed for London Underground for use within the tunnels and above surface, the system incorporates flame retardant, non halogen polyolefin heat shrink tubing with a meltable inner liner that itself has excellent flame retardant properties with reduced acid gas emission and smoke generation.

The system incorporates a flexible outer fire barrier tube that provides a high degree of fire resistance. For installations outside of the tunnels, this can be omitted.



For ease of use, the range can be supplied with range finding mechanical shearbolt connectors. Slim in profile, the joints can be installed in horizontal and vertical planes and have an unlimited shelf life.

Joints to Suit Single or 2/3/4 Core XLPE / EPR Cables

Part Number	Cable Range	Voltage
SPA NHF 1.5-2.5 –	1.5-2.5mm ²	600/1000V
SPA NHF 4-6 –	4-6mm ²	600/1000V
SPA NHF 10-16 –	10-16mm ²	600/1000V
SPA NHF 25-50 –	25-50mm ²	600/1000V
SPA NHF 70-95 –	70-95mm ²	600/1000V
SPA NHF 120-185 –	120-185mm ²	600/1000V
SPA NHF 240-300 –	240-300mm ²	600/1000V
SPA NHF 400-630 –	400-630mm ²	600/1000V
SPA NHF 800-1000 –	800-1000mm ²	600/1000V

Notes:

1. For non armoured joints, omit letter (A) from the part number
2. Add last digit to part number to indicate number of cores



Joints to Suit Multicore / Multipair XLPE / EPR Cables

Part Number	Cable Range	Voltage
SPA NHF 1.5-2.5-5	5 core 1.5-2.5mm ²	600/1000V
SPA NHF 1.5-2.5-7	7 core 1.5-2.5mm ²	600/1000V
SPA NHF 1.5-2.5-12	12 core 1.5-2.5mm ²	600/1000V
SPA NHF 1.5-2.5-19	19 core 1.5-2.5mm ²	600/1000V
SPA NHF 1.5-2.5-27	27 core 1.5-2.5mm ²	600/1000V
SPA NHF 1.5-2.5-37	37 core 1.5-2.5mm ²	600/1000V
SPA NHF 1.5-2.5-48	48 core 1.5-2.5mm ²	600/1000V
SPA NHF 1.5-2.5-61	61 core 1.5-2.5mm ²	600/1000V

Notes:

1. For non armoured joints, omit letter (A) from the part number
2. Add letter "PR" to end of part number to indicate multipair cables
3. If cable size is 0.5-1.5mm², insert 0.5-1.5mm after SPA NHF then number of cores

Low Voltage Zero Halogen Cable Joints for Fire Resistant Cables



- Designed for use where low smoke fume and fire resistance is essential
- Designed and tested in leading UK fire testing laboratory, in accordance with the procedures specified in IEC 60331-21:1999
- Test report available
- Joints available for all types of LV and MV cables

Fire resistant cables are usually installed where vital electrical circuits are required to continue operating in the event of a fire. Shrink Polymer Systems can provide joint kits to suit these cable types for both single and multicore configurations.

In addition to utilising LSF/Zero halogen heat shrink tubes and fire barrier tubes, the joints also incorporate mica tape over each of the cores.

Mica tape is a slit silica tape constructed from 96% pure SiO₂ silica fiber, coated one side with a pressure sensitive adhesive backing that facilitates installation. The adhesive decomposes at high temperatures, leaving a perfectly taped core

Suitable for use at 1800°F (982°C), and able to withstand short term exposure up to 3000°F (1650°C), mica tape when combined with our proven zero halogen joint range, enables the joint to work in these extreme conditions.





Airfield Lighting Heat Shrink Joint Kits

- A full range of heat shrink joint kits for all airfield ground lighting cables
- Approved for use on Defence Estates RAF Bases within the UK and all major BAA civilian airports
- Thousands of joints installed worldwide on both military and civil airfields



Part Number	Cable Type	Connector Type
SPS 1003	New Primary 6mm ² Joint	Non Insulated
SPS 1003U	Primary 6mm ² to Itself or 8AWG	Non Insulated
SPS 036	Secondary 2 Core 2.5-6mm ²	Insulated
SPS 1004	Primary Armoured 6mm ² to Non Armoured 6mm ²	Non Insulated
SPS 1005	Primary CU Braided 6mm ² Armoured	Non Insulated
SPS 1005	Primary Brass Tape 6mm ² Armoured	Non Insulated
SPS 1014	Primary 5kV Non Screened 6mm ² Cable	Non Insulated
SPS 1015	Primary 5kV Screened 6mm ² Cable	Non Insulated

Traffic Control Cable Heat Shrink Joint Kits

- A comprehensive range of heat shrink joints traffic, motorway and communication cables
- Approved by Department of Transport and Traffic Control Systems Unit London
- Incorporates our unique black melt tape for superior internal moisture sealing

Part Number	To Suit Cable Type
SPS 013	Loop to Armoured Feeder (1 Pair)
SPS 021	Loop to Armoured Feeder (2 Pair)
SPS 022	Loop to Armoured Feeder (3 Pair)
SPS 023	Loop to Armoured Feeder (4 Pair)
SPS 012	Loop to Non Armoured (1 Pair) Twin Flex
SPS 018	4-8 Multicore SWA
SPS 019	12, 16-20 Multicore SWA
SPS 020	Feeder to Feeder 1-2 PAIR SWA
SPS 017	Loop to Loop (10 PER PACK)
SPS 031	3, 4 Pair to 2, 3, 4 Pair With 1 Pair Off
SPS 047	7-8 Core Temporary Traffic Light Cable (Lux Type)
SPS 148	2 Pair Telephone (Motorway)
SPS 035	20-30 Pair Telecom (Motorway)
SPS 162	30 Pair Uninterrupt (Motorway)
SPS 167	Split Concentric 10mm ² (Motorway)
SPS 168	Split Concentric 25mm ² (Motorway)





Low Voltage Live Pot End Kits

Standard heat shrink end caps are often used to seal cable ends. However where cables are live, heat shrink live pot end kits should be used. Each core is separately sealed using small end caps and a screen bandage is applied to re-instate earth fault protection. Finally a thick wall outer heat shrink cap is applied marked with a live flash symbol.

Kits are available for XLPE and PILC cables although any cable type can be catered for if details are given.



The table below shows only the popular 4 core kits, for 2 or 3 core kits the codes should be changed by substituting the figure 4 shown after the cable range to either 2 or 3.

Example: For a 3 core XLPE kit 35mm², the correct code should be POT 4-35-3X

Part Number PILC Cable	Cable Range (mm ²)	Part Number XLPE Cable
POT 4-10-4PB	4 Core 4-10	POT 4-10-4X
POT 16-35-4PB	4 Core 16-35	POT 16-35-4X
POT 50-95-4PB	4 Core 50-95	POT 50-95-4X
POT 120-185-4PB	4 Core 120-185	POT 120-185-4X
POT 240-400-4PB	4 Core 240-400	POT 240-400-4X

Low Voltage Cable Abandonment Kits

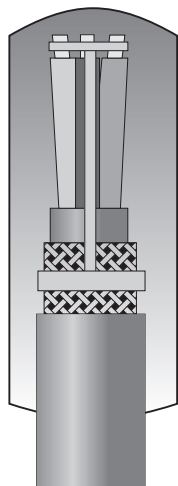

Heat shrink end caps are regularly used to seal cable ends. However, where a cable has been abandoned or overlayered, there is always a danger of mis-identification.

Shrink Polymer Systems range of abandonment kits effectively links all the individual cores to each other and earth. Using a simple insulation tester makes identifying the cable as abandoned a relatively simple matter, ensuring the cable is not accidentally energised.

Kits are available for XLPE and PILC although any cable type can be catered for if details are given.

The table below shows only the popular 4 core kits, for 2 or 3 core kits the codes should be changed by substituting the figure 4 shown after the cable range to either 2 or 3.

Example: For a 3 core XLPE kit 120mm², the correct code should be: SPAK 50-150-3X

Part Number PILC Cable	Cable Range (mm ²)	Part Number XLPE Cable
SPAK 4-35-4PB	4 Core 4-35	SPAK 4-35-4X
SPAK 50-150-4PB	4 Core 50-150	SPAK 50-150-4X
SPAK 185-300-4PB	4 Core 185-300	SPAK 185-300-4X



Heat Shrink Cable Entry Glands

- Six sizes cover cable diameters from 4mm through to 70mm
- Provides a watertight seal and secure fixing to gland plate/box
- Ideal for non armoured (except PICAS) power or fibre optic cables
- Approved and used by various UK regional electricity companies for use on 95-300mm² 11kV PICAS cables
- Flame retardant



The HCS series of heat shrinkable cable entry glands were developed to provide a cost effective method of providing a weatherproof seal on a wide variety of cables.

The glands are manufactured in accordance with MIL-1-81765/1 and MIL-1-23053/15 specifications and provide a flame retarded adhesive lined body along with a male threaded part to enable fixture to the gland plate.

The range comprises six different sizes as detailed below.



Ref No	Cable O/D max	Cable O/D min	Bulkhead Thickness Max	Length Rec	Drill Hole
HCS 1	12mm	4mm	6mm	95mm	26mm
HCS 2	17mm	7mm	6mm	95mm	26mm
HCS 3	26mm	13mm	6mm	100mm	35mm
HCS 4	38mm	19mm	6mm	130mm	51mm
HCS 4s	53mm	19mm	10mm	170mm	60mm
HCS 5	70mm	36mm	6mm	200mm	88mm



Nylon Compression Glands

NG nylon glands are ideal alternatives to high cost brass glands. They are particularly suited to the glanding of single core non armoured power cables from 0.6 to 36kV and provide an IP 68 weatherproof seal.



Part Number	Thread	Clamping Range	To Suit Single Core 600/1000V XLPE/PVC
NG 25	25mm	13-18mm	50-95mm ²
NG 32	32mm	17.5-25mm	120-185mm ²
NG 40	40mm	24.5-31.5mm	240-300mm ²
NG 50s	50mm	31-37mm	400-500mm ²
NG 50	50mm	36.5-43mm	630mm ²
NG 63s	63mm	42.5-50mm	800mm ²
NG 63	63mm	48.5-55mm	1000mm ²

Heat Shrink Cable Repair and Busbar Tape

- Low cost option for repairs to damaged cable sheaths
- Ideal for use on busbar tee sections
- Available in various widths

Shrink Polymer Systems type AT heat shrink tape is manufactured from modified polyethylene and coated on one side with a meltable adhesive.

It has a number of uses but the main ones include cable sheath repair and the insulation of busbar tee sections.

The tape should firstly be secured with the tab tape supplied, then applied turn by turn whilst shrinking with a suitable heat source.



Part Number	Width	Roll Length
AT 25-5	25mm	5mtr
AT 25-15	25mm	15mtr
AT 50-5	50mm	5mtr
AT 50-15	50mm	15mtr
AT 75-5	75mm	5mtr
AT 75-15	75mm	15mtr



Low Voltage Heat Shrink Breakout Boots

Made from cross linked polyolefin and adhesive coated, these breakouts can be used in wide variety of applications. The sizes listed below are available from stock, other sizes available upon request.

Part Number	Legs	Skirt Dia (mm)		Leg Dia (mm)	
		Exp	Rec	Exp	Rec
2CB 30/12	2	30	12	14	4.5
2CB 40/16	2	40	16	15	5.0
2CB 60/23	2	60	23	25	7.5
3CB 38/17	3	38	17	14	4.5
3CB 60/25	3	60	25	25	8.0
3CB 80/38	3	80	38	35	11
3CB 110/50	3	110	50	46	18
3CB 125/57	3	125	57	55	20
4CB 40/15	4	40	15	14	3.5
4CB 65/26	4	65	26	26	7.0
4CB 82/37	4	82	37	30	9.0
4CB 100/47	4	100	47	38	12
4CB 125/52	4	125	52	52	15
5CB 80/33	5	80	33	26	8.0
5CB 100/42	5	100	42	34	10



Low Voltage Heat Shrink End Caps

- Adhesive lined to prevent water ingress
- Thick wall for extra strength and durability
- UV stable
- A range of live pot end kits available

Part Number	Cable Dia. (mm)	Expanded Dia. (mm)	Recovered Dia. (mm)
C12-4	4-7	12	4
C14-5	5-9	14	5
C25-8.5	9-20	25	8.5
C35-16	17-30	35	16
C40-15	16-35	40	15
C55-26	27-48	55	26
C75-36	37-65	75	36
C100-52	55-88	100	52
C120-60	65-105	120	60
C145-60	65-130	145	60
C160-82	85-145	160	82



Shrink Polymer Systems end caps are made from a semi-rigid cross linked polyethylene material which offers excellent weathering and abrasion resistance.

A full range of LV live pot end and abandonment kits are also available for most cable types, see page 49 for more details.



Heat Shrink Wraparound Repair Sleeves

- Reliable repair of damaged cable sheaths
- Suitable for use with both LV, MV and telecom cable applications
- Thermochromatic paint applied to assist with proper shrinkage



Stainless Steel Rail Type

Wraparound repair sleeves offer an easy to apply effective solution for the repair of damage to outer sheaths for all cable types.

Used extensively worldwide to provide the outer protection and sealing of telecommunication cables, they are equally useful for power cable joint outer sealing reducing trench excavation.

Part Number	Exp Dia (mm)	Rec Dia (mm)	Length (mtr)
SWRS 43/10	42	10	1000mm
SWRS 50/15	50	15	1000mm
SWRS 75/22	75	22	1000mm
SWRS 105/30	105	30	1000mm
SWRS 146/38	146	38	1000mm
SWRS 198/55	188	55	1000mm
SWRS 210/60	210	60	1000mm

Materials

Item	Test Condition and method	Requirement
Bursting Strength	Test Temp: 23±5°C	Min 3000N
Thermal Ageing Bursting Strength	168Hrs at 150±2°C (After Free Shrinkage)	Min 5000N
Dielectric strength	Electrode Surface Dia: 6mm. Weight: 50±2gms. Voltage Steps: 2kV/20sec	Min 12 kV/mm
Split Resistance	Temp: 200±2°C. Test time 23±3°C	No split Propagation
Carbon Content UV Res of Out/layer	Heating Rate: 20°C/min. Gas Flow Rate: 300cc/min	Min 2.5%
Cold Crack Resistance	Test temp: ≤ -40°C	No crack
Resistance to Aggressive Media Bursting Strength	Test Media: Fuel Oil, Petroleum Jelly. Test Temp: 70 ± 2°C	Min 2000N
Environmental Stress cracking	10% Igepal Co 630. Solution Immersion Time: 30 days Test Temp: 50 ± 3°C	No cracking
Temp. indicating paint conversion	Scraped Off Paint From Sleeve	230-250°C

Hot melt adhesive

Item	Test method and conditions	Requirements
Peel Strength	-PE at 23±2°C. -PE at 23±2°C. -Pb at 23±2°C	Min 100N/25mm
Shear Strength	At 23±2°C	Min 200N
Corrosive Effect	Copper Mirror Test Test Time:16hrs. Test Temp:60±2°C	No Effect



Connector Patch Tape

- Quick and easy to apply
- Excellent electrical properties
- Tough heavy duty PVC backing
- Completely watertight when bonded
- No heat required
- Used in conjunction with resin joint kits

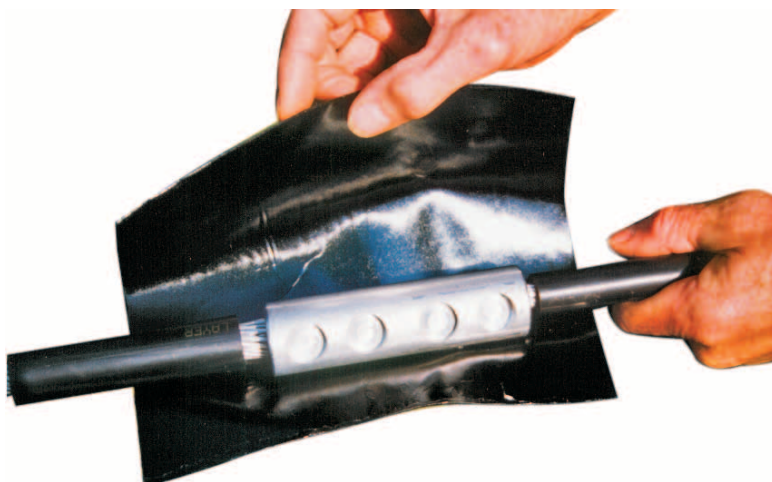

Shrink Polymer Systems type SP 50D connector insulation patch tape is ideally suited for the insulation of connectors within cable joint systems.

Made from heavy duty PVC and coated with mastic on one side, it can easily be cut to shape or size to suit the particular style of connector. Another benefit is that the application requires no heat as the patch tape seals to itself upon contact, creating a reliable moisture proof connection.

SP 50D tape is available in 15mtr rolls in widths up to 900mm and can be cut to size to suit individual requirements.

Physical Properties

Backing Colour	–	Black
Backing Type	–	PVC
Backing Thickness	ASTM D1000	375 microns
Total Thickness	ASTM D1000	1.1 mm
Elongation	ASTM D1000	300%
Tape Strength	ASTM D1000	9 N/mm
Adhesion (1800 Peel) to Self	ASTM D1000	3.5 N/mm
Tear Strength	ASTM D1004	25/30 N

Electrical Properties

Dielectric Strength	ASTM D1000	30kV
Insulation resistance	ASTM D257	10 ¹² ohm

Storage

Temp Range in Service	–	-30 to +75°C
Temp Range in Storage	–	Up to 35°C



Thin Wall Heat Shrink Sleeve

- Available in a wide variety of colours
- Flame retardant as standard but zero halogen types also available
- Shrink ratio 2/1 but 3/1 and 4/1 can also be supplied
- Continuous operating temperature range -55°C to +125°C

An extensive range of thin wall tube is available, including types for zero halogen, high shrink ratio, teflon, kynar and pvc applications. Please enquire if not listed.

The materials are generally supplied on reels but can also be supplied in cut lengths, please check with Shrink Polymer Systems.

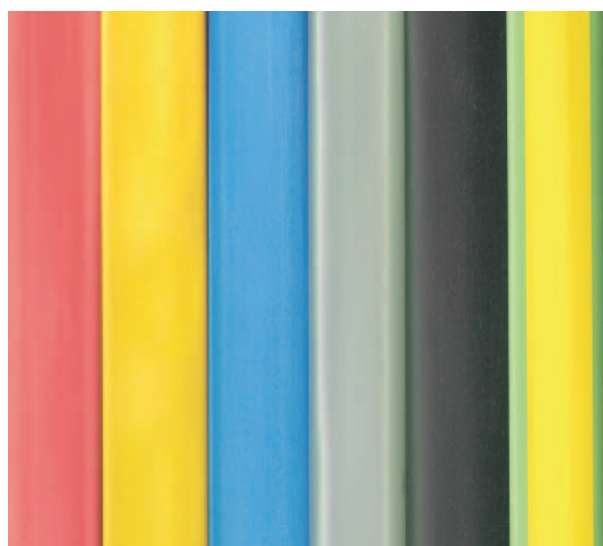

Standard Flame Retardant Type			
Part Number	Shrink Range	Wall Thickness	Reel Length
TWM 12	0.6-1.2mm	0.45mm	300mtr
TWM 16	0.8-1.6mm	0.50mm	300mtr
TWM 24	1.2-2.4mm	0.55mm	300mtr
TWM 32	1.6-3.2mm	0.55mm	300mtr
TWM 48	2.4-4.8mm	0.55mm	300mtr
TWM 64	3.2-6.4mm	0.65mm	300mtr
TWM 95	4.8-9.5mm	0.65mm	150mtr
TWM 127	6.4-12.7mm	0.65mm	100mtr
TWM 191	9.5-19.1mm	0.80mm	100mtr
TWM 254	12.7-25.4mm	0.95mm	100mtr
TWM 320	16-32mm	1.05mm	50mtr
TWM 381	19.1-38.1mm	1.05mm	50mtr
TWM 508	25.4-50.8mm	1.30mm	50mtr
TWM 762	38.1-76.2mm	1.30mm	25mtr
TWM 1016	50.8-101.6mm	1.40mm	25mtr

* Specify Colour Required

Green / Yellow Striped Type			
Part Number	Shrink Range	Wall Thickness	Reel Length
SGY 64	3.2-6.4mm	0.64mm	300mtr
SGY 95	4.8-9.5mm	0.64mm	150mtr
SGY 127	6.4-12.7mm	0.64mm	150mtr
SGY 191	9.5-19.1mm	0.76mm	100mtr
SGY 254	12.7-25.4mm	0.89mm	50mtr
SGY 381	19.1-38.1mm	1.02mm	50mtr



Medium and Thick Wall Adhesive Lined Heat Shrink Tube

- High resistance to abrasion, corrosion and chemicals
- Meets the requirements of ESI 09-11
- Adhesive lined ensures fully watertight seal
- Up to 4/1 shrink ratio as standard 6/1 ratio also available
- Used in direct buried or under water applications
- Major approvals held



Shrink Polymer Systems type TMC and TMI medium and thick wall tube, is used primarily within a wide variety of heat shrink joint and termination systems to provide excellent insulation and sealing properties even when operating in the most severe locations.

Medium wall provides more flexibility whilst thick wall provides yet more strength and durability.

Where extreme diameters are encountered, we are able to offer heat shrink tubes and other heat shrink products that can insulate diameters up to 1520mm. Further details are available upon request.

Medium Wall Product		
Part Number	Shrink Range	Wall Thickness Full Recovery
TMC 12-4	4-12mm	1.8mm
TMC 22-6	6-22mm	2.2mm
TMC 28-6	6-28mm	2.5mm
TMC 33-8	8-33mm	2.5mm
TMC 40-12	12-40mm	2.5mm
TMC 55-16	16-55mm	2.7mm
TMC 75-22	22-75mm	3.0mm
TMC 95-25	25-95mm	3.0mm
TMC 115-34	34-115mm	3.3mm
TMC 140-42	42-140mm	3.5mm
TMC 205-65	65-205mm	3.5mm



Thick Wall Product		
Part Number	Shrink Range	Wall Thickness Full Recovery
TMI 9-3	3-9mm	1.8mm
TMI 12-3	3-12mm	1.8mm
TMI 22-6	6-22mm	2.2mm
TMI 33-8	8-33mm	3.2mm
TMI 45-12	12-45mm	4.1mm
TMI 55-16	16-55mm	4.1mm
TMI 75-22	22-75mm	4.1mm
TMI 95-29	29-95mm	4.3mm
TMI 130-36	36-130mm	4.3mm
TMI 160-55	55-160mm	4.3mm
TMI 200-65	65-200mm	4.3mm

Standard Lengths Available

Medium Wall 1200 and 1500mm,

Thick Wall 1200 and 1500mm,

Other lengths available on request

Property	Test Method	Performance
Tensile Strength	ASTM D638	14.0MPA
Ultimate Elongation	ISO 37	>400%
Operating Temperature	IEC 216	-550C to +1100C
Min Shrink Temperature	–	1200C
Longitudinal Change	UL 224	±10%
Specific Gravity	ISO/R1183	1.1
Dielectric Strength	IEC 243	>20kV/mm
Elongation after Heat Ageing	ISO 37 (168 hrs at 150°C)	>300%
Heat Shock	ASTM D2671	No dripping, flowing (4 hrs at 225°C) or cracking
Low Temperature Flexibility	ASTM D1693 (4 hrs at -55°C)	No cracking or splitting
Water Absorbtion	ISO 62	<0.15%
Fluid Resistance Various Fluids	ISO 1817, ISO 37 MIL-1-23053	Good to excellent



Medium / Thick Wall Zero Halogen Adhesive Lined Heat Shrink Tube

- Complies with London Underground Ltd Engineering Standard E1042:A6:March 2002
- Sizes available from 3mm expanded diameter up to 120mm and lengths of up to 1.2mtr
- 3/1 shrink ratio
- Joint kits available for all cable types utilising W3-NH material



Shrink Polymer Systems can now offer from stock, W3 NH which is a flexible high-grade dual-wall flame-retardant, non-halogen, polyolefin heat shrink tubing. It has a meltable inner liner that itself has excellent flame-retardancy with reduced acid gas emission and smoke generation. It complies with the strictest standards required within the mass-transit engineering industry.

For moisture and environmental protection of harnesses and connectors in all smoke sensitive areas such as surface

or underground public transport, rail vehicles, tunnels, power plants, hospitals, airports and submarines where smoke generation and toxic emissions must be kept to a minimum for safety reasons.

The same tube is incorporated within a wide variety of heat shrinkable joints available for all cable types (see pages 46-47).

Part No	Internal Dia Exp (mm)	Internal Dia Rec (mm)	Wall Thickness Rec (mm)	Standard Length
W3 NH 3/1	3	1	0.96	1200mm
W3 NH 6/2	6	2	1.19	1200mm
W3 NH 9/3	9	3	1.27	1200mm
W3 NH 12/4	12	4	1.40	1200mm
W3 NH 19/6	19	6	1.80	1200mm
W3 NH 24/8	24	8	2.50	1200mm
W3 NH 40/13	40	13	2.50	1200mm
W3 NH 50/19	50	19	4.00	550mm
W3 NH 75/25	75	25	3.00	610mm
W3 NH 120/40	120	40	3.00	1200mm

Note: Cut lengths available upon request



Special Tapes

Black Melt Void Filling Tape

Shrink Polymer Systems tape type 212D is a black mastic tape that is used within joint kits to provide an effective internal moisture seal. When heat is applied to the joint, the tape melts and flows within, filling any voids. The tape is also used within a number of submersible heat shrink joint kits supplied to various offshore oil companies.

212D is generally supplied as follows:

Length	300mm
Width	50mm
Thickness	2mm

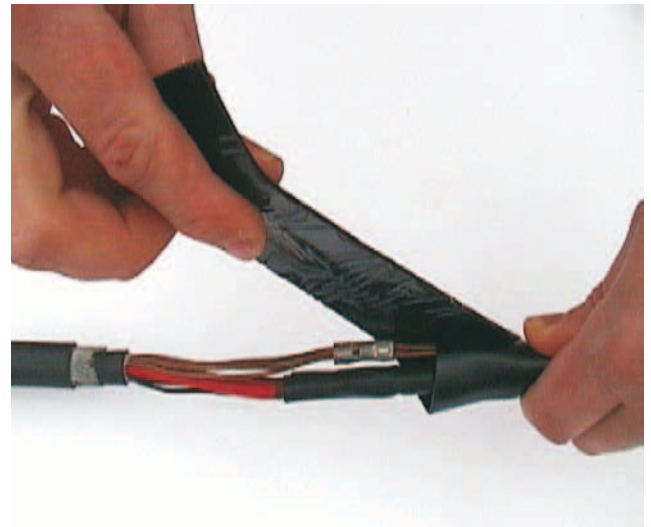

Self Amalgamating Tape

Shrink Polymer Systems type SP 130 is a high quality self amalgamating tape with excellent electrical properties. It adheres very well to most surfaces and provides a high abrasion resistant moisture proof seal.

SP 130 is 0.75mm thick and comes on a 10 mtr roll, it is available in both 25 and 38mm widths.

Zero Halogen Melt Tape

Shrink Polymer Systems type SCMT 25 is a zero halogen adhesive melt tape that is primarily used in conjunction with heat shrink tubes, mouldings and zero halogen low smoke fume applications within cable joint systems.

SCMT 25 is generally supplied on a 50mtr roll with a width of 25mm. It can also be supplied in cut lengths if preferred.

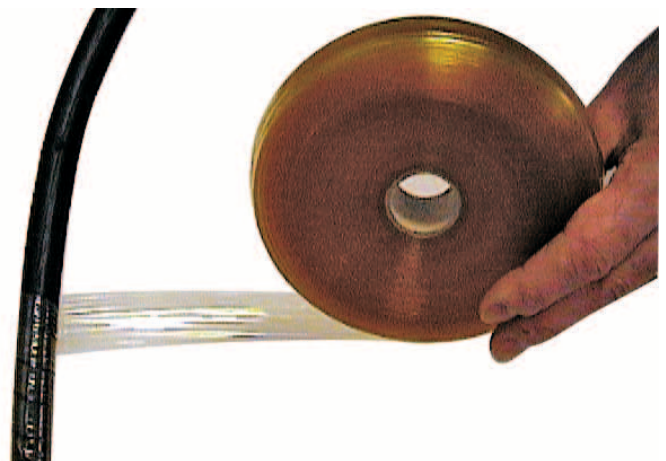



Low Voltage Copper Crimp Lugs and Ferrules

- Manufactured in the UK from the highest quality seamless copper tube to BS 2871/C106
- Designed, manufactured and tested to comply with BS 4579
- Special non standard products can be supplied to suit a multitude of different applications



Conductor Size (mm ²)	Part Number Single Hole Lug	Part Number 2 Hole Lug	Part Number 4 Hole Lug	Ferrule
6	T6-M –	–	–	F6
10	T10-M –	–	–	F10
16	T16-M –	–	–	F16
25	T25-M –	–	–	F25
35	T35-M –	–	–	F35
50	T50-M –	–	–	F50
70	T70-M –	T70-2-M –	T70-4-M –	F70
95	T95-M –	T95-2-M –	T95-4-M –	F95
120	T120-M –	T120-2-M –	T120-4-M –	F120
150	T150-M –	T150-2-M –	T150-4-M –	F150
185	T185-M –	T185-2-M –	T185-4-M –	F185
240	T240-M –	T240-2-M –	T240-4-M –	F240
300	T300-M –	T300-2-M –	T300-4-M –	F300
400	T400-M –	T400-2-M –	T400-4-M –	F400
500	T500-M –	T500-2-M –	T500-4-M –	F500
630	T630-M –	T630-2-M –	T630-4-M –	F630
800	T800-M –	T800-2-M –	T800-4-M –	F800
1000	T1000-M –	–	T1000-4-M –	F1000

The above products are all from our heavy duty range, we can also supply products from the standard range where cost consideration is of primary importance.

Low Voltage Mechanical Shearbolt Connectors

LV shearbolt connectors are ideal for situations where exact conductor sizes are not known or where joining copper to aluminium conductors.



Part Number	Cable Range (mm ²)	Length (mm)	Height (mm)	Width (mm)
MC1	35-95	90	32	26
MC2	95-150	100	36	31
MC3	185-300	130	44.5	42



Miscellaneous Tools

Gas Torch Kits

Two gas torch kits are available complete with burner heads that were specifically developed for use with heat shrink products.

SPS 201

This kit features an auto ignite handle, hot air burner head, hose and fittings and adaptors so that standard propane cylinders or the ultra portable primus 2000 cylinders can be used.

SPS 202

The kit comes with the standard handle and heat shrink burner head, cylinder adaptor and hose and fittings.



Ratchet Cable Cutter - Part Number SPCC 380

The SPCC 380 is a hand operated ratchet tool that is designed to cut non steel wire armoured copper and aluminium cables up to 35mm² diameter (300mm LV XLPE / PVC cable approx). The precision ground blades provide long service life and the tool also features a safety catch. Length 340mm, Weight 1.2kg

Other models are available upon request.



Ratchet Crimp Tool Part Number CR 1

The CR 1 is a high quality tool designed for use with pre-insulated crimp terminals ranging from 0.5-6mm² (reds, blues and yellows). Its unique feature is that the dies are equal both sides which eliminates the danger of applying an insulation crimp to the terminal itself.

Ratchet Crimp Tool Part Number CRN 1

The CRN 1 is a high quality tool designed for use with non-insulated crimp terminals ranging from 0.25-10mm².

The CRN 1 was used in tests for 6mm² and 8AWG connector tests and approved for use on AGL cables by what was the the DOE / PSA. now Defence Estates.





Minimum Clearances Required for Indoor Termination Kits

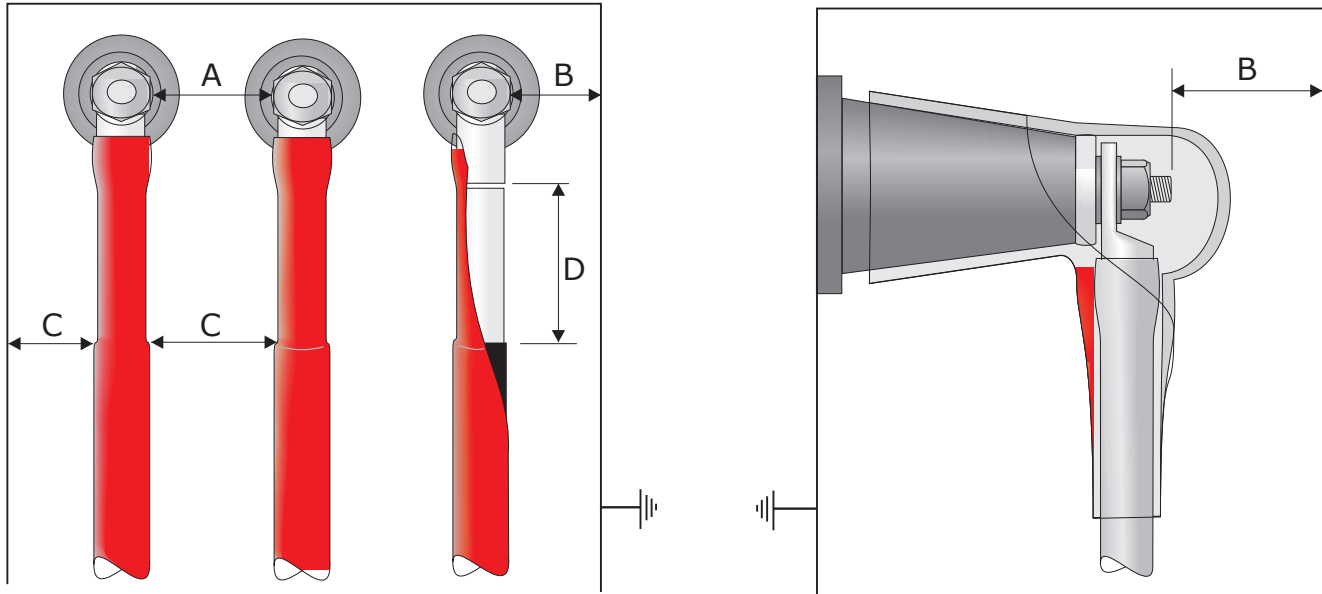

- Check the cable box for minimum clearances and refer to table 1 below.
- If actual dimension 'A' and 'B' is less than the value given, a bushing boot must be fitted.

Table 1 – Minimum Air Clearances for Terminations in Cable Boxes in Accordance with BS 164 Class A.

Maximum System Voltage, Phase to Phase (kV)	7.2	12	24	36
Minimum Air Clearance Between Live Metal 'A' (mm)	90	127	242	356
Minimum Air Clearance Between Live Metal and Earth 'B' (mm)	65	75	140	222

Table 2 – Minimum Air Clearances for Terminations in Cable Boxes in Accordance with BS 164 Class A. with Bushing Boots Fitted

Maximum System Voltage, Phase to Phase (kV)	7.2	12	24	36
Minimum Air Clearance Between Live Metal 'A' (mm)	45	75	100	125
Minimum Air Clearance Between Live Metal and Earth 'B' (mm)	32	60	75	100

Table 3 – Minimum Clearance Between Cores and Between Cores and Earth

Maximum System Voltage, Phase to Phase (kV)	7.2	12	24	36
Minimum Clearance 'C' (mm) Measured From top of Stress Tubes	15	20	40	50

Table 4 – Minimum Clearance Between top of The Stress Control Tubing and Base of the Cable Lug.

Maximum System Voltage, Phase to Phase (kV)	7.2	12	24	36
Minimum Clearance 'D' (mm)	30	50	95	250

Table 5 – Impulse Voltage Withstand for Indoor Terminations, Installed With Bushing Boots, on Bushings in Accordance with BS2562.

Maximum System Voltage, Phase to Phase (kV)	7.2	12	24	36
Impulse Withstand Voltage (kV)	75	95	125	170



Shrink Polymer Systems

Cable Installation Materials – 24 volts to 36 kV

Unit E3, Crown Way, Crown Park Industrial Estate, Rushden, Northants, UK, NN10 6FD

Tel: +44 (0)1933 356758 **Fax:** +44 (0)1933 413821 **Email:** info@shrinkpolymersystems.co.uk

Skype: shrinkpolymersystems www.shrinkpolymersystems.co.uk

Notes



Shrink Polymer Systems

Cable Installation Materials – 24 volts to 36 kV

Unit E3, Crown Way, Crown Park Industrial Estate, Rushden, Northants, UK, NN10 6FD

Tel: +44 (0)1933 356758 **Fax:** +44 (0)1933 413821 **Email:** info@shrinkpolymersystems.co.uk

Skype: shrinkpolymersystems **www:** www.shrinkpolymersystems.co.uk

Notes



Cable Conversion Chart

Imperial (")	AWG	Metric (mm ²)
0.0045	12-10	2.9
0.007	12-10	4.5
0.01	12-10	6.5
0.0145	8	9.4
0.0225	6	16
0.04	4	25
0.06	2	35
0.075	1/0	50
0.1	2/0	70
0.15	3/0	95
0.2	4/0	120
0.25	300MCM	150
0.3	400MCM	185
0.35	500MCM	240
0.4	600MCM	260
0.5	600MCM	300
0.55	—	350
0.6	800MCM	400
0.75	1000MCM	500
1.0	1200MCM	630
1.25	1500MCM	800
1.5	2000MCM	1000

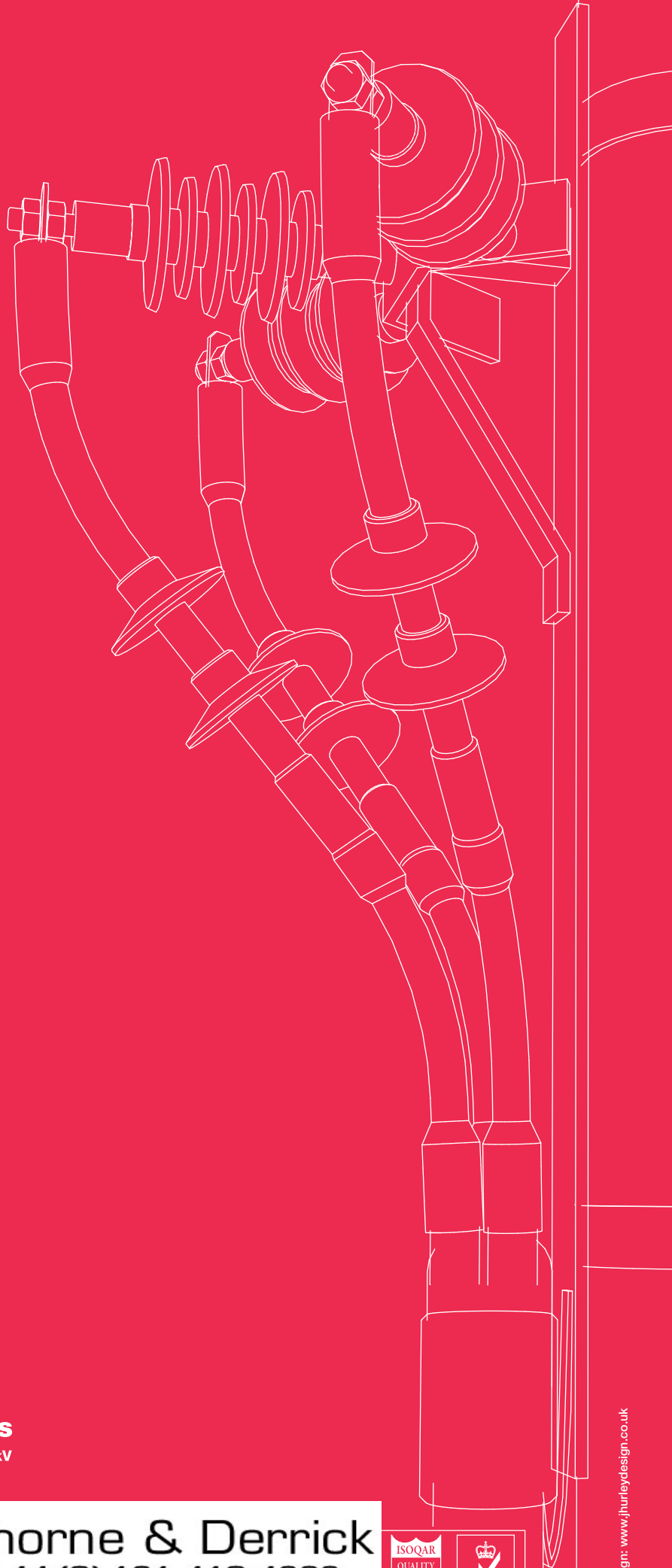

Shrink Polymer Systems

Cable Installation Materials – 24 volts to 36 kV



**THORNE &
DERRICK**
INTERNATIONAL

Thorne & Derrick

+44 (0) 191 410 4292

www.powerandcables.com



Certificate Number 1865