



Furse earthing & lightning protection

UK Shortform



- Bare, stranded & tinned conductors
- Hard drawn bar & covered conductors
- Air termination
- Conductor network clamps & fixings
- Earth electrodes & fittings
- Earth bonds & clamps
- Earth bars
- FurseWELD
- Electronic systems protection

With over 125 years of experience Furse provides world leading earthing, lightning and electronic systems protection solutions. From our own designed and manufactured products, through to risk assessment and systems design advice, Furse offers a renowned total solution for earthing and lightning protection.

Table of contents

008–007	Introduction
008–010	Conductors
011–012	Air termination
013–020	Conductor network
021–022	Earth electrodes
023–026	Earth bonds & clamps
027–028	Earth bars
029–031	FurseWELD
032–038	Electronic systems protection

Introduction

Our reach & expertise

Furse was acquired by the ABB Group in 2012, and through the wider distributor network ABB offers, the Furse brand is established as a world leader in earthing and lightning protection, with our products specified and installed in many prestigious projects globally.

— 01 Conductors

— 02 Earthing & lightning protection clamps

— 03 Earth bars

The combined expertise of Furse and the experience within the electrical sector ABB provides, allows us to share the knowledge we hold in key industry sectors with our customers. In turn, this promotes properly informed decision making on the best earthing and lightning protection solutions.

Why use Furse?

Expertise

Specialist advice from our fully qualified technical engineers – focusing on your earthing and lightning protection issues and concerns.

Experience

Providing the optimum solution – one that doesn't use more material than is necessary, saving you money.

Design solutions

Using the latest computer aided design & modelling software we can produce detailed or budgetary earth electrode and lightning protection system designs for any system complexity, in compliance with globally recognised standards.

Full earthing analysis uses state-of-the-art software to determine the step and touch voltages, earth potential rise and fall, and hot/cold site classification of the site generated by the initial design.

Our services include:

- Lightning protections solutions
- Soil resistivity surveys
- Analysis & earthing design
- Earth resistance testing

Knowledge

Our knowledge of the latest standards ensures designs and selected products comply with the latest IEC/BS EN/NFPA/UL standards.

Products

Our knowledge of the latest products ensures a tailored design that can be installed using the most appropriate and up-to-date products.

Customer service

Our sales and technical teams are ready to assist with all your earthing and lightning protection needs. Contact Furse on 0115 964 3700 or 0333 999 9900.



01



02



03





EARTHING & LIGHTNING PROTECTION

Lightning is one of nature's most powerful and destructive phenomena. Lightning strikes present a real and significant threat to life, to the structures in which we live and work, and to the electronic systems which support us.



01



02



03



04

01 Datacentres

02 Trackside substations

03 Water treatment

04 Telecommunications

05 Wind farms

06 Oil & gas

07 Healthcare

08 Substations

Earthing & lightning protection

A real & significant threat

Lightning contains awesome amounts of electrical energy. Lightning discharges have been measured from several thousand to over 200,000 Amps (enough to light half a million 100 Watt bulbs) and even though of a very short duration, can cause tremendous damage and destruction.

The consequences of lightning can be devastating:

- Direct lightning strikes damage structures, and create fire, explosion and electric shock hazards.
- Indirect lightning (up to a kilometre away) creates transient overvoltages which degrade electronic systems and disrupt essential services.

Secondary effects of lightning

The effects of a direct strike are obvious and immediately apparent – buildings damaged, trees blown apart, personal injuries and even loss of life.

However, the secondary effects of lightning – the short duration, high voltage spikes called transient overvoltages – can, and do, cause equally catastrophic, if less visually obvious, damage to electronic systems within structures.

The need for a total solution

Lightning protection throughout the world is now governed by National and International standards which stress the need for a comprehensive solution. Simply put, a structural lightning protection system cannot and will not protect electronic systems from lightning currents and transient overvoltages, that's



05



06



07

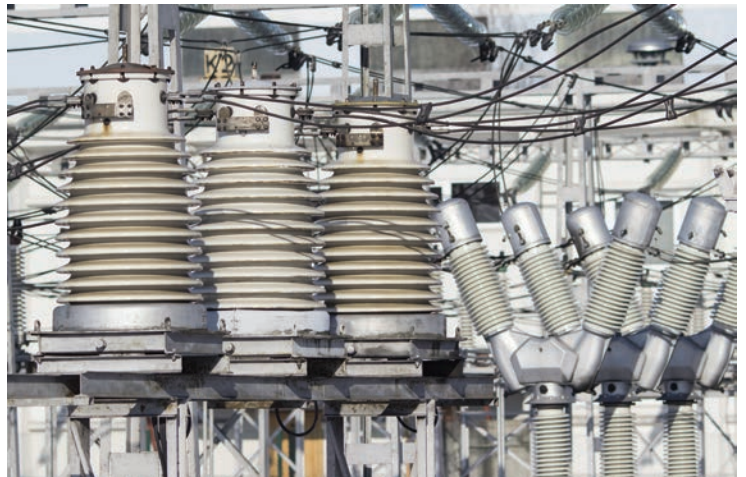

08

09 ESP M1 mains power surge protection device

10 Earth rod seal

11 Threaded & unthreaded copperbond earth rod

why we advocate a Total Solution to earthing and lightning protection. This approach to lightning protection is now fully endorsed by the IEC/BS EN 62305, as well as NFPA 780 standards.

Therefore, the Furse approach delivers effective life safety, together with long lasting, reliable protection of a structure and the electronic systems within it. We believe the Furse Total Solution is the best available solution for achieving effective, dependable, long term lightning protection and earthing.

Protecting against the consequences of lightning is now of paramount importance in any building design, so our Total Solution covers a wide range of sectors, for which we have tailored products and services.



09



10

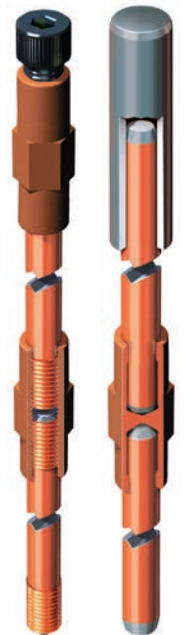

11

Conductors

Bare conductors, bare stranded & tinned conductors

Bare copper tape



Part no.	Conductor size (mm)
TC005	12.5 x 1.5
TC010	12.5 x 3
TC015	20 x 1.5
TC020	20 x 3
TC020/100	20 x 3
TC025	25 x 1.5
TC026	25 x 2
TC030	25 x 3
TC030/50	25 x 3
TC035	25 x 4
TC040	25 x 6
TC042	30 x 3
TC044	30 x 4
TC043	30 x 5
TC045	31 x 3
TC048	31.5 x 4
TC050	31 x 6
TC055	38 x 3
TC060-FU	38 x 5
TC065	38 x 6
TC067	40 x 3
TC066	40 x 4
TC071	40 x 5
TC068	40 x 6
TC069	40 x 6.3
TC070	50 x 3
TC075	50 x 4
TC078	50 x 5
TC080	50 x 6
TC082	50 x 6.3
TC090	50 x 7
TC092	50 x 8
TC094	50 x 10
TC096	60 x 10
TC098	80 x 6
TC099	100 x 6

Bare aluminium tape



Part no.	Conductor size (mm)
TA005	12.5 x 1.5
TA020	20 x 3
TA030	25 x 3
TA042	30 x 3
TA040	25 x 6
TA068	40 x 6
TA080	50 x 6

Bare stranded copper cable



Part no.	Cross sectional area (mm ²)
Soft drawn stranded copper cable	
CB006	6
CB016	16
CB025	25
CB035	35
CB050-FU	50
CB070	70
CB095	95
CB120	120
CB150-FU	150
CB185	185
CB240	240
CB300-FU	300
CB400-FU	400
Hard drawn stranded copper cable	
CB071	70

Bare & tinned solid circular



Part no.	Diameter (mm)
Copper conductor	
CD035	Ø 8
Aluminium conductor	
CD080	Ø 8
Tinned copper conductor	
CD235	Ø 8

Tinned copper tape



Part no.	Conductor size (mm)
TC225-FU	12.5 x 1.5
TC220	20 x 3
TC230	25 x 3
TC239	30 x 2
TC240	25 x 6
TC245	31 x 3
TC260	38 x 5
TC266	40 x 4
TC280	50 x 6

Conductors

Hard drawn bar & PVC covered conductors

Hard drawn copper bar

	Part no.	Overall nominal size (mm)
	BA205	25 x 3
	BA210	25 x 6
	BA225	38 x 6
	BA230	50 x 6
	BA235	50 x 10
	BA240	75 x 6
	BA250-FU	100 x 6

PVC covered aluminium tape

	Part no.	Conductor size (mm)	Colour range
	TA105	25 x 3	Black
	TA110	25 x 3	Green
	TA115	25 x 3	Grey
	TA120	25 x 3	Stone
	TA125	25 x 3	White
	TA130	25 x 3	Brown
	TA140	25 x 6	Green

PVC covered copper tape

	Part no.	Conductor size (mm)	Colour range
	TC100	12.5 x 1.5	Black
	TC105-FU	25 x 3	Black
	TC105/50	25 x 3	Black
	TC110	25 x 3	Green
	TC110/50	25 x 3	Green
	TC115-FU	25 x 3	Grey
	TC115/50	25 x 3	Grey
	TC120-FU	25 x 3	Stone
	TC120/50	25 x 3	Stone
	TC125-FU	25 x 3	White
	TC125/50	25 x 3	White
	TC130	25 x 3	Brown
	TC130/50	25 x 3	Brown
	TC140-FU	25 x 6	Green
TC145	50 x 6	Green	

Green & yellow PVC insulated copper tape

	Part no.	Conductor size (mm)
	TC111-FU	25 x 3
	TC111/50	25 x 3

LSOH covered copper tape

	Part no.	Conductor size (mm)	Colour range
	TC910	25 x 3	Green
	TC910/50	25 x 3	Green
	TC940	25 x 6	Green
	TC980	50 x 6	Green

Lead covered copper tape

	Part no.	Conductor size (mm)	Colour range
	TC330	25 x 3	Grey

Green & yellow PVC insulated stranded copper cable

	Part no.	Cross-sectional area (mm ²)
	CC016	16
	CC025	25
	CC035	35
	CC050	50
	CC070	70
	CC095	95
	CC120-FU	120
	CC150-FU	150
	CC185	185
	CC240	240
	CC300	300
	CC400-FU	400

Conductors

PVC covered conductors & guards

PVC covered copper solid circular

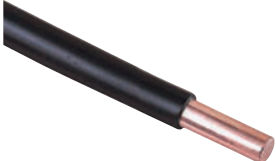

Part no.	Colour range
CD036	Black
CD038	Grey
CD039	Stone
CD040	White
CD041	Brown

N.B. All conductor diameters 8 mm.

PVC protective down conductor guard



Part no.	Length (mm)	Colour range
GC205	3,000	Black
GC215	3,000	Grey
GC220	3,000	Stone
GC225	3,000	White
GC230	3,000	Brown

PVC covered aluminium solid circular



Part no.	Colour range
CD081	Black
CD083	Grey
CD084	Stone
CD085	White
CD086	Brown

N.B. All conductor diameters 8 mm.

Anti-vandal down conductor guard



Part no.	Length (mm)
AV005	3,000

Air termination

Air terminals, bases, brackets & couplings

Air rod

Part no.	Rod length (mm)	Rod diameter (mm)	Thread size	Conductor material
RA215	500	Ø 15	M16	Copper
RA225	1,000	Ø 15	M16	Copper
RA230	1,500	Ø 15	M16	Copper
RA240	2,000	Ø 15	M16	Copper
RA250-FU	3,000	Ø 15	M16	Copper
RA015	500	Ø 15	M16	Aluminium
RA025	1,000	Ø 15	M16	Aluminium
RA030	1,500	Ø 15	M16	Aluminium
RA040	2,000	Ø 15 </td <td>M16</td> <td>Aluminium</td>	M16	Aluminium
RA050	3,000	Ø 15	M16	Aluminium
RA400-FU	500	Ø 10	M10	Copper
RA402	1,000	Ø 10	M10	Copper
RA080	500	Ø 10	M10	Aluminium
RA085	1,000	Ø 10	M10	Aluminium



Air rod base

Part no.	Air rod diameter (mm)	Max. conductor width (mm)	Conductor material
SD105-H	Ø 15	25	Copper
SD003-H	Ø 15	25	Aluminium
SD120	Ø 15	50mm ²	Copper

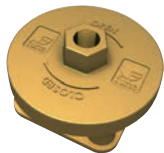

Flat saddle

Part no.	Rod diameter (mm)	Conductor diameter (mm ²)	Conductor material
SD155	Ø 15	50	Copper
SD160	Ø 15	70	Copper
SD165	Ø 15	95	Copper

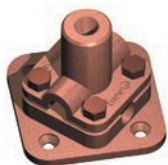

Ridge saddle

Part no.	Rod diameter (mm)	Max conductor width (mm)	Conductor material
SD115	Ø 15	31	Copper
SD015	Ø 15	31	Aluminium



Horizontal or vertical air rod base

Part no.	Rod diameter (mm)	Thread size	Conductor material
Vertically mounted			
SD307	Ø 8	M10	Copper
SD007	Ø 8	M10	Aluminium
Horizontally mounted			
SD305	Ø 8	M10	Copper
SD005	Ø 8	M10	Aluminium

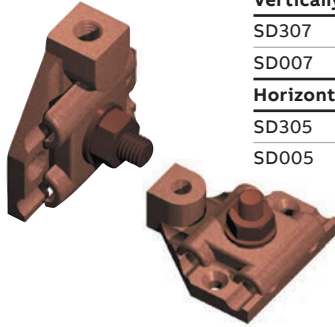

Rod to conductor coupling

Part no.	Rod diameter (mm)	Rod material
For use with flat tape conductor		
CG600	Ø 15	Copper
CG500	Ø 15	Aluminium
For use with stranded conductor		
CG705	Ø 15	Copper
CG710	Ø 15	Aluminium



Rod brackets

Part no.	Rod diameter (mm)	Rod material
BR105	Ø 15	Copper
BR005	Ø 15	Aluminium



Trapezoidal holdfast with air rod base

Part no.	Conductor
TZ405	25 x 3 mm / Ø 8 mm bare copper
TZ407	25 x 3 mm / Ø 8 mm bare aluminium



Air termination

Multiple point, strike pad & free-standing air termination

Multiple point

Part no.	Rod diameter (mm)	Rod material
RA600	Ø 15	Copper
RA500	Ø 15	Aluminium



Strike pad

Part no.	Conductor material
PL010	Copper
PL005	Aluminium
SM010	Copper stem for use with PL010
SM005	Stainless steel stem for use with PL005

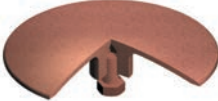

Free-standing interception pole

Part no.	Pole height (m)	Pole diameter (mm)	Pole make up
912000-FU	3	Ø 10-42	2 piece
912001-FU	3.5	Ø 10-42	2 piece
912002-FU	4	Ø 10-42	2 piece
912003-FU	4.5	Ø 10-42	2 piece
912004-FU	5	Ø 10-42	2 piece
912005-FU	5.5	Ø 10-42	2 piece
912006-FU	6	Ø 16-60	3 piece
912007-FU	6.5	Ø 10-60	3 piece
912008-FU	7	Ø 16-60	3 piece
912009-FU	7.5	Ø 10-60	3 piece
912010-FU	8	Ø 16-60	3 piece
912011-FU	9	Ø 10-60	3 piece
912013-FU	10	Ø 10-60	3 piece



Base frame

Part no.	Frame type	Dimension (mm)
499000-FU	Square base	650 x 650
499005-FU	Tripod base	1,350 x 1,350
499006-FU	Tripod base	1,850 x 1,850
499007-FU	H shaped base	1,850 x 1,850



Dimensions are approximate and include concrete base dimensions.

Free-standing interception pole base

Part no.	Description	Weight each (kg)
499100-FU	Square concrete base 300 x 300 x 60 mm	12
499101-FU	Square concrete base 300 x 300 x 80 mm	16
103103-FU	Circular concrete base with M16 insert	12
103101-FU	Circular concrete base with M16 insert	16
103110-FU	Circular concrete base with M16 insert	20
103118-FU	Circular concrete base with M16 insert	25

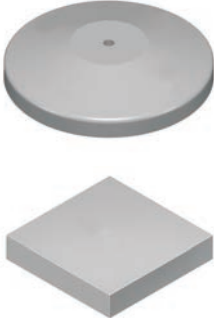

Accessories	
103102-FU	Protective polyethylene tray for circular concrete blocks
919828-FU	Stainless steel clamp for connecting 25 x 3 mm copper tape to 5-19 mm thickness steel

Conductor network

Conductor clips

Swing lid tape clip



Part no.	Conductor size (mm)
For use with bare copper	
CP210-H	25 x 3
CP220-H	25 x 6
For use with bare aluminium	
CP110-H	25 x 3
CP120-H	25 x 6
For use with PVC covered copper	
CP215-H	25 x 3

Tape clip



Part no.	Conductor width (mm)	Conductor thickness (mm)
For use with bare copper		
CP205	20	3
CP210	25	3-4
CP220	25	5-6
CP230	30-32	3-4
CP235	30-32	5-6.5
CP240	38-40	3-4
CP245	38-40	5-6.5
CP255	50	3-4
CP260	50	5-6.5
For use with PVC covered copper		
CP215	25	3-4
CP225	25	6
CP265	50	6
For use with lead covered copper		
CP305	25	3
For use with bare aluminium		
CP105	20	3
CP110	25	3-4
CP125	50	6
For use with PVC covered aluminium		
CP115	25	3
CP130	50	6

Pressed tape clip



Part no.	Conductor size (mm)
For use with bare copper	
CP510	20 x 3
CP515	25 x 3
For use with bare aluminium	
CP405	20 x 3
CP410	25 x 3
CP415	25 x 6
For use with PVC covered tape	
CP517	25 x 3

Adjustable tape clip



Part no.	Conductor size (mm)
For use with bare copper	
CP230-H	31 x 3 and 31 x 6
CP240-H	38 x 3, 38 x 6 and 40 x 6
CP260-H	50 x 3 and 50 x 6

One hole cable clip



Part no.	Conductor size (mm)	Conductor material
For use with solid circular conductor		
CP905	Ø 8	Copper
CP925	Ø 8	Aluminium
CP915	Ø 10*	Copper
CP935	Ø 10*	Aluminium
For use with stranded conductor		
CP910	50 mm ²	Copper
CP915	70 mm ²	Copper
CP920	95 mm ²	Copper

*PVC covered Ø8 mm conductor.

Heavy duty cast cable saddle



Part no.	Conductor size (mm)	Conductor material
For use with solid circular conductor		
CP805	Ø 8	Copper
CP806	Ø 8	Aluminium
CP815	Ø 10*	Copper
CP816	Ø 10*	Aluminium
For use with stranded conductor		
CP810	50 mm ²	Copper
CP815	70 mm ²	Copper
CP835	95 mm ²	Copper
CP840	120 mm ²	Copper

*PVC covered Ø8 mm conductor.

Non-metallic tape clip



Part no.	Conductor size (mm)	Colour
For use with bare tape		
CP005	20 x 3	Brown
CP010	20 x 3	Grey
CP015	25 x 3	Brown
CP020	25 x 3	Grey
CP065	50 x 6	Brown
For use with PVC covered tape		
CP025	25 x 3	Brown
CP030	25 x 3	Black
CP035	25 x 3	Green
CP040	25 x 3	Grey
CP045	25 x 3	Stone
CP050	25 x 3	White

Conductor network

Conductor clips

Non-metallic push-in clip



Part no.	Conductor size (mm)	Colour
For use with bare solid circular conductor		
CP887	Ø 8	Brown
CP872	Ø 8	Grey
For use with PVC covered solid circular conductor		
CP886	Ø 10*	Brown
CP861	Ø 10*	Black
CP871	Ø 10*	Grey
CP876	Ø 10*	Stone
CP881	Ø 10*	White

*PVC covered Ø8 mm conductor.

Glue down tape clip



Part no.	Conductor size (mm)	Colour
For use with bare tape		
GD015	25 x 3	Brown
GD020	25 x 3	Grey
For use with PVC covered tape		
GD025	25 x 3	Brown
GD030	25 x 3	Black
GD040	25 x 3	Grey
GD045	25 x 3	Stone
GD050	25 x 3	White

Glue down push-in clip



Part no.	Conductor size (mm)	Colour
For use with bare solid circular conductor		
GD887	Ø 8	Brown
GD872	Ø 8	Grey
For use with PVC covered solid circular conductor		
GD886	Ø 10*	Brown
GD861	Ø 10*	Black
GD871	Ø 10*	Grey
GD876	Ø 10*	Stone
GD881	Ø 10*	White

*PVC covered Ø8 mm conductor.

Self adhesive tape clip



Part no.	Conductor size (mm)	Colour
For use with bare tape		
CA015-FU	25 x 3	Brown
CA020-FU	25 x 3	Grey
For use with PVC covered tape		
CA025-FU	25 x 3	Brown
CA030-FU	25 x 3	Black
CA040-FU	25 x 3	Grey
CA045-FU	25 x 3	Stone
CA050-FU	25 x 3	White

Self adhesive push-in clip



Part no.	Conductor size (mm)	Colour
For use with bare solid circular conductor		
CA872	Ø 8	Brown
CA887	Ø 8	Grey
For use with PVC covered solid circular conductor		
CA886	Ø 10*	Brown
CA861	Ø 10*	Black
CA871	Ø 10*	Grey
CA876	Ø 10*	Stone
CA881	Ø 10*	White

*PVC covered Ø8 mm conductor.

Solvent weldable tape clip



Part no.	Conductor size (mm)	Colour
For use with bare tape		
CW015-FU	25 x 3	Brown
CW020-FU	25 x 3	Grey
For use with PVC covered tape		
CW025-FU	25 x 3	Brown
CW030-FU	25 x 3	Black
CW040-FU	25 x 3	Grey
CW045-FU	25 x 3	Stone
CW050-FU	25 x 3	White

Clips for solid circular conductor available to order.

Conductor network

Conductor clips & accessories

Heat weldable clip for PVC roofing

	Part no.	Conductor size (mm)	Colour
	For use with bare tape		
	HW015-FU	25 x 3	Brown
	HW020-FU	25 x 3	Grey
	For use with PVC covered tape		
	HW025-FU	25 x 3	Brown
	HW030-FU	25 x 3	Black
	HW040-FU	25 x 3	Grey
	HW045-FU	25 x 3	Stone
	HW050-FU	25 x 3	White

Clips for solid circular conductor available to special order.

Heat weldable clip for TPO/FPO roofing

	Part no.	Conductor size (mm)	Colour
	For use with bare tape		
	HW315	25 x 3	Brown
	HW320	25 x 3	Grey
	For use with PVC covered tape		
	HW325	25 x 3	Brown
	HW330	25 x 3	Black
	HW340	25 x 3	Grey
	HW345	25 x 3	Stone
	HW350	25 x 3	White

Clips for solid circular conductor available to special order.

Heat weldable clip for polyethylene roofing

	Part no.	Conductor size (mm)	Colour
	For use with bare tape		
	HW415	25 x 3	Brown
	HW420	25 x 3	Grey
	For use with PVC covered tape		
	HW425	25 x 3	Brown
	HW430	25 x 3	Black
	HW440	25 x 3	Grey
	HW445	25 x 3	Stone
	HW450	25 x 3	White

Clips for solid circular conductor available to special order.

Non-metallic clip accessories

	Part no.	Description
	CW905	Universal welding solvent 500 ml
	CW999	Cleaning solution 500 ml
	CA900	Surface primer 250 ml
	DT100	Dressing tool - For use with tape clips

Bitumen felt roof clip

	Part no.	Conductor size (mm)	Colour
	For use with bare tape		
	FP015	25 x 3	Brown
	FP020	25 x 3	Grey
	For use with PVC covered tape		
	FP025	25 x 3	Brown
	FP030	25 x 3	Black
	FP040	25 x 3	Grey
	FP045	25 x 3	Stone
	FP050	25 x 3	White

Conductor network

Standing seam roof fixings, puddle flange and holdfasts

Standing seam roof fixing with square tape clamp



Part no.	Conductor size (mm)	Material
SC105-H	25 x 3	Copper
SC005-H	25 x 3	Aluminium

Slate holdfast with non-metallic tape clip



Part no.	Conductor size (mm)	DC clip Colour
For use with bare tape		
HF015	25 x 3	Brown
HF020	25 x 3	Grey
For use with PVC covered tape		
HF025	25 x 3	Brown
HF030	25 x 3	Black
HF040	25 x 3	Grey
HF045	25 x 3	Stone

Standing seam roof fixing with tape clip



Part no.	Conductor size (mm)	Colour	Material
Non-metallic clip for use with bare tape			
SC015	25 x 3	Brown	Copper
SC020	25 x 3	Grey	Aluminium
Metallic clip for use with bare tape			
SC210-H	25 x 3	-	Copper
SC110-H	25 x 3	-	Aluminium
Metallic clip for use with PVC covered tape			
SC215-H	25 x 3	-	Copper
Non-metallic clip for use with PVC covered tape			
SC025	25 x 3	Brown	Cu / Al
SC030	25 x 3	Black	Cu / Al
SC035	25 x 3	Green	Cu / Al
SC040	25 x 3	Grey	Cu / Al
SC045	25 x 3	Stone	Cu / Al
SC050	25 x 3	White	Cu / Al

Slate holdfast with non-metallic push-in clip



Part no.	Conductor size (mm)	DC clip colour
HF176	Ø 8	Brown
HF191	Ø 8	Grey

Glazing bar holdfast

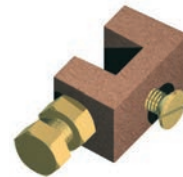

Part no.	Maximum glazing bar width (mm)	Conductor material
HF705	12	Copper
HF710	12	Aluminium

Back plate holdfast stem



Part no.	Conductor material
HF320	Copper
HF325-FU	Aluminium

Puddle flange



Part no.	Conductor material
PF105	Copper
PF005	Aluminium

Pyramid holdfast



Part no.	Conductor size (mm)
HF975	Ø 8 mm solid circular

Conductor network

Trapezoidal holdfasts and conductor clamps

Trapezoidal holdfast with square tape clamp



Part no.	Conductor
TZ105	25 x 3 mm bare copper tape
TZ005	25 x 3 mm bare aluminium tape

Cable to tape square clamp



Part no.	Conductor size	Conductor material
CT125	25 x 3 mm to 50 mm ²	Copper
CT130	25 x 3 mm to 70 mm ²	Copper
CT135	25 x 3 mm to 95 mm ²	Copper

Trapezoidal holdfast with conductor clip



Part no.	Conductor
TZ210	25 x 3 mm bare copper tape
TZ110	25 x 3 mm bare aluminium tape
TZ040	25 x 3 mm grey PVC covered tape
TZ805	Ø 8 mm bare copper
TZ806	Ø 8 mm aluminium copper
TZ815	Ø 8 mm PVC covered copper
TZ816	Ø 8 mm PVC covered aluminium
TZ871	Ø 8 mm grey PVC covered

Cable to cable square clamp



Part no.	Conductor size (mm ²)	Conductor material
CR810	50	Copper
CR815	70	Copper
CR820	95	Copper

Square tape clamp



Part no.	Conductor size (mm)	Conductor material
CT105-H	25 x 3	Copper
CT110-H	25 x 6	Copper
CT115-H	50 x 6	Copper
CT005-H	25 x 3	Aluminium
CT010	25 x 6	Aluminium

Square clamp



Part no.	Conductor size (mm)	Conductor material
CS605	Ø 8	Copper
CS610	Ø 8	Aluminium

Crossover tape clamp



Part no.	Conductor size (mm)	Conductor material
CX105-H	25 x 3	Copper
CX005-H	25 x 3	Aluminium

Tee clamp



Part no.	Conductor size (mm)	Conductor material
CS505	Ø 8	Copper
CS510	Ø 8	Aluminium

Conductor network

Conductor clamps and accessories

Jointing clamp



Part no.	Conductor size (mm)	Conductor material
CS405	Ø 8	Copper
CS410	Ø 8	Aluminium

Test clamp



Part no.	Conductor size (mm)	Conductor material
CN305	Ø 8	Copper
CN310	Ø 8	Aluminium

Test / Junction clamp



Part no.	Conductor size (mm)	Conductor material
CN105-H	26 x 8	Copper
CN005	26 x 8	Aluminium

Square test clamp



Part no.	Conductor size (mm ²)	Conductor material
CR855	50	Copper
CR860	70	Copper
CR865	95	Copper

Plate type test clamp



Part no.	Conductor size (mm)	Conductor material
CT405	26 x 12 max	Copper

Bimetallic connector



Part no.	Conductor size
CN910	25 x 3 mm aluminium tape to 25 x 3 mm copper tape
CN915	8 mm Ø aluminium conductor to 8 mm Ø copper conductor
CN920	8 mm Ø aluminium conductor to 25 x 3 mm copper tape
CN925	25 x 3 mm aluminium tape to 25 x 3 mm copper tape

Screwdown test clamp



Part no.	Conductor size (mm)	Conductor material
CT305	26 x 8 max	Copper

Expansion braid bond



Part no.	Description	Conductor material
BN101	Single length	Copper
BN001	Single length	Aluminium
BN102	Cross-over	Copper
BN002	Cross-over	Aluminium

Conductor network

Accessories

Countersunk wood screws

	Part no.	Size	Material
	SW105	1½" x No.10	Zinc plated steel
	SW110	1½" x No.12	Zinc plated steel
	SW005	1½" x No.10	Brass
	SW010	1½" x No.12	Brass

Roundhead wood screws

	Part no.	Size	Material
	SW405	1½" x No.10	Zinc plated steel
	SW305	1½" x No.10	Brass

Roundhead copper nails

	Part no.	Length (mm)
	NA005	50

Plain washers

	Part no.	Size (mm)	Material
	WR365	6	Phosphor bronze
	WR367	10	Phosphor bronze
	WR370	12	Phosphor bronze
	WR165	6	Brass
	WR175	8	Brass
	WR167	10	Brass
	WR170	12	Brass
	WR265	6	Stainless steel 316
	WR266	8	Stainless steel 316
	WR267	10	Stainless steel 316

Hexagon nuts

	Part no.	Size	Material
	NU367	M10	Phosphor bronze
	NU370	M12	Phosphor bronze
	NU165	M6	Brass
	NU166	M8	Brass
	NU167	M10	Brass
	NU170	M12	Brass
	NU265	M6	Stainless steel 316
	NU266	M8	Stainless steel 316
	NU267	M10	Stainless steel 316

Roundhead rivets

	Part no.	Size (mm)	Material
	RV105	5 x 12	Copper
	RV110	5 x 20	Copper

Countersunk set screws

	Part no.	Size	Material
	SS160	M6 x 30	Brass
	SS260	M6 x 30	Stainless steel 316

Hexagon head set screws

	Part no.	Size	Material
	SS635	M10 x 25	Phosphor bronze
	SS640	M10 x 35	Phosphor bronze
	SS650	M12 x 25	Phosphor bronze
	SS655	M12 x 35	Phosphor bronze
	SS165	M8 x 16	Brass
	SS140	M10 x 25	Brass
	SS145	M10 x 35	Brass
	SS150	M12 x 25	Brass
	SS155	M12 x 35	Brass
	SS235	M8 x 20	Stainless steel 316
	SS240	M10 x 25	Stainless steel 316
	SS245	M10 x 35	Stainless steel 316

Hexagon head set screws

	Part no.	Size (mm)	Material
	WS365	6	Phosphor bronze
	WS367	10	Phosphor bronze
	WS370	12	Phosphor bronze
	WS265	6	Stainless steel 316
	WS266	8	Stainless steel 316
	WS267	10	Stainless steel 316

Plastic wall plugs

	Part no.	Size	Material
	PS305	No.10	Red
	PS310	No.12	Brown

Conductor network

Accessories

Silfos

	Part no.	Coil size	Thickness
	FS005	50 mm x 8 m	0.12 mm



Insulating tape

	Part no.	Size
	TP120-FU	25 mm x 33 m



Oxide inhibiting compound

	Part no.	Description
	CM005	Plastic 8 oz bottle



Waterproofing tape

	Part no.	Size
	TD005	50 mm x 10 m



Earth electrodes

Earth rods & seal

Threaded copperbond earth rod



Part no.	Nominal diameter (in)	Length (mm)
RB105	Ø ½	1,200
RB110	Ø ½	1,500
RB115	Ø ½	1,800
RB125	Ø ½	2,400
RB205-FU	Ø ⅝	1,200
RB210	Ø ⅝	1,500
RB215	Ø ⅝	1,800
RB220-FU	Ø ⅝	2,100
RB225	Ø ⅝	2,400
RB235	Ø ⅝	3,000
RB305	Ø ¾	1,200
RB310	Ø ¾	1,500
RB315	Ø ¾	1,800
RB320-FU	Ø ¾	2,100
RB325	Ø ¾	2,400
RB335	Ø ¾	3,000
Fittings	Type	
CG170	½" Coupling	
CG270	⅝" Coupling	
CG370	¾" Coupling	
ST100	½" Driving stud	
ST200	⅝" Driving stud	
ST300	¾" Driving stud	

Unthreaded copperbond earth rod



Part no.	Diameter (mm)	Length (mm)
RB005	Ø 9.0	1,200
RB107	Ø 12.7	1,500
RB203	Ø 14.2	1,200
RB213	Ø 14.2	1,500
RB236	Ø 14.2	3,000
RB317	Ø 17.2	2,000
RB326	Ø 17.2	2,400
RB336	Ø 17.2	3,000
Fittings	Type	
CG177	12.7 mm Coupling	
CG277	14.2 mm Coupling	
CG377	17.2 mm Coupling	
ST107	12.7 mm Driving head	
ST207	14.2 mm Driving head	
ST307	17.2 mm Driving head	

Earth rod seal



Part no.	Type
Earth rod seal assembly	
ES300	Earth rod seal and membrane seal
Earth rod seal pack	
ES300-12	Seal pack for ½" (Ø 12.7 mm) Copperbond rod
ES300-58	Seal pack for ⅝" (Ø 14.2 mm) Copperbond rod
ES300-34	Seal pack for ¾" (Ø 17.2 mm) Copperbond rod
ES300-15	Seal pack for Ø 15 mm solid copper rod
ES300-16	Seal pack for Ø 16 mm stainless steel rod
ES300-20	Seal pack for Ø 20 mm solid copper rod
Earth rod seal tube	
ES310-03	Seal tube, 300 mm length
ES310-05	Seal tube, 500 mm length
ES310-10	Seal tube, 1,000 mm length
ES310-15	Seal tube, 1,500 mm length
ES310-20	Seal tube, 2,000 mm length
ES310-30	Seal tube, 3,000 mm length
Accessory spanner set	
ES320	Membrane seal torque spanner set

Earth electrodes

Earth rods, inspection pits, plate, lattice & backfill materials

Solid copper and stainless steel earth rod

Part no.	Diameter (mm)	Length (mm)
Solid copper rod		
RC010	Ø 15	1,200
RC011	Ø 15	1,500
RC012	Ø 15	3,000
RC015	Ø 20	1,200
RC016	Ø 20	1,500
RC017	Ø 20	3,000
Stainless steel rod		
RS005	Ø 16	1,200
RS011	Ø 16	1,500
RS012	Ø 16	3,000
RS016	Ø 20	1,500
RS017	Ø 20	3,000
Fittings		Type
ST010	15 mm hardened steel driving stud for copper/stainless steel rod	
ST015	20 mm hardened steel driving stud for copper/stainless steel rod	
CG013	Coupling dowel for 15 mm & 20 mm copper rod	
CG005	Coupling dowel for 16 mm & 20 mm stainless steel rod	
SP010	15 mm hardened steel spike for copper/stainless steel rod	
SP015	20 mm hardened steel spike for copper/stainless steel rod	



Lightweight inspection pit

Part no.	Description
PT205	Lightweight inspection pit with grey polymer lid
PT110	Lightweight inspection pit with concrete lid
PT004	5 hole earth bar
Accessories for polymer lid	
AK005	6 mm Allen key
Accessories for concrete lid	
JH100	M8 x 100 mm long mild steel 'J' bolt lifting
AS100	M8 x 60 stainless steel Allen caphead screw (2 per lid)



Concrete inspection pit

Part no.	Description
PT005	Concrete earth inspection pit
PT006	5 hole earth bar
PT007	7 hole earth bar



Earth plate (solid copper)

Part no.	Size (mm)
PE005	600 x 600 x 1.5
PE015	900 x 900 x 1.5
PE010	600 x 600 x 3
PE020	900 x 900 x 3



FurseCEM® conductive aggregate / Bentonite moisture retaining clay

Part no.	Description	Length
CM025	FurseCEM®	
CM030	FurseCEM® (supplied with cement)	
CM015	Bentonite powder 25kg	
CM020	Bentonite granules 25kg	



Earth mat (lattice copper)

Part no.	Size (mm)
PE110	600 x 600 x 3
PE120	900 x 900 x 3



Earth bonds & clamps

Mechanical clamps

Rod to tape clamp (type A)

Part no.	Nominal rod diameter		Max. conductor (mm)
	(in)	(mm)	
CR105	Ø ½	Ø 12.7	26 x 12
CR105	Ø ⅝	Ø 16	26 x 12
CR105	Ø ¾	Ø 20	26 x 10
CR108	Ø ⅝	Ø 16	30 x 2
CR108	Ø ¾	Ø 20	30 x 2
CR110	Ø ⅝	Ø 16	40 x 12
CR115	Ø ⅝	Ø 16	51 x 8
CR125	Ø ¾	Ø 20	51 x 12
CR130	Ø ½	Ø 12.7	26 x 20
CR130	Ø ⅝	Ø 16	26 x 18
CR130	Ø ¾	Ø 20	26 x 10
CR130	Ø 1	Ø 25	26 x 10

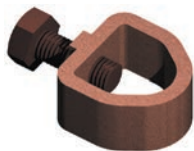

Rod to cable clamp (type G)

Part no.	Nominal rod diameter		Max. conductor (mm²)
	(in)	(mm²)	
CR505	Ø ⅝	Ø 9.5	6-35
CR510-FU	Ø ½	Ø 12.7	16-50
G5	Ø ⅝	Ø 16	5.2-33.6
CR515	Ø ⅝	Ø 16	16-70
G6	Ø ¾	Ø 20	5.2-33.6
CR520	Ø ¾	Ø 20	35-95
CR525	Ø 1	Ø 25	70-150



'U' bolt rod clamp (type E)

Part no.	Nominal rod/rebar diameter		Hole centres (mm)
	(in)	(mm²)	
CR305	Ø ⅝	Ø 16	37
CR310	Ø ¾	Ø 20	37
CR315	Ø 1	Ø 25	37
CR320*	Ø ⅝	Ø 16	37
CR325	Ø 1½	Ø 38	54
CR326*	Ø 1½	Ø 38	54
CR330	Ø 2	Ø 50	64

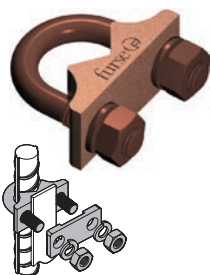

*CR320 and CR326 include additional plate to allow tape to be clamped without drilling.

'U' bolt rod clamp (type GUV)

Part no.	Nominal rod/rebar diameter		Conductor range (mm²)
	(in)	(mm)	
CR700	Ø ⅝	Ø 16	16-95
CR700	Ø ¾	Ø 20	16-70
CR705	Ø ⅝	Ø 16	70-185
CR705	Ø ¾	Ø 20	70-150
CR730	Ø ⅝	Ø 16	150-300
CR730	Ø ¾	Ø 20	150-300
CR710	Ø 1	Ø 25	16-70
CR740	Ø 1	Ø 25	70-150
CR750	Ø 1	Ø 25	150-300



Rod to cable clamp (type B)

Part no.	Nominal rod diameter		Rod type
	(in)	(mm)	
CR205	Ø ⅜	Ø 9.5	Copperbond
CR215	Ø ⅝	Ø 16	Copperbond
CR220	Ø ⅝	Ø 15	Solid copper
CR225	Ø ¾	Ø 20	Copperbond
CR230	Ø ¾	Ø 20	Solid copper



Rebar clamp

Part no.	Conductor size (mm)	Rebar dia. (mm)	Conductor material
BN150	Ø 8	Ø 8-18	Copper
BN155	Ø 8	Ø 18-38	Copper



Rebar to rebar connecting clip

Part no.	Rebar diameter A (mm)	Rebar diameter B (mm)
RR812	Ø 8	Ø 12
RR1616	Ø 16	Ø 16
RR2121	Ø 20	Ø 20
RR2626	Ø 25	Ø 25
RR3232	Ø 32	Ø 32
RR3838	Ø 40	Ø 40

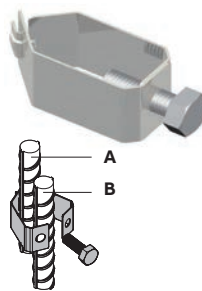

Rebar to conductor connecting clip

Part no.	Rebar diameter (mm)	Conductor size (mm)
Rebar to flat tape		
RC25-087095	Ø 25	25 x 3mm
Rebar to stranded/solid circular conductor		
RC812-0850	Ø 12	50 mm² or Ø 8mm
RC16-087095	Ø 16	Ø 8 mm dia., 50-70-95 mm²
RC20-087095	Ø 20	Ø 8 mm dia., 50-70-95 mm²
RC25-087095	Ø 25	Ø 8 mm dia., 50-70-95 mm²
RC32-087095	Ø 32	Ø 8 mm dia., 50-70-95 mm²
RC40-087095	Ø 40	Ø 8 mm dia., 50-70-95 mm²

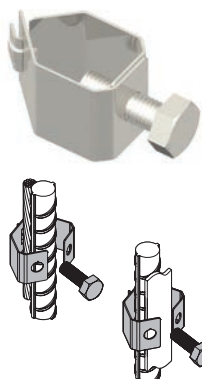

Earth bonds & clamps

Earth boss, bonds & clamps

Earth boss

	Part no.	Length (mm)	Diameter (mm)	Thread size (mm)
	EB0111	30	Ø 30	M10
	EB1111	30	Ø 30	M10
	EB0111-SS	30	Ø 30	M10
	EB1111-SS	30	Ø 30	M10
	EB0121	30	Ø 40	M10
	EB1121	30	Ø 40	M10
	EB0121-SS	30	Ø 40	M10
	EB1121-SS	30	Ø 40	M10
	EB0221	40	Ø 40	M10
	EB1221	40	Ø 40	M10
	EB0221-SS	40	Ø 40	M10
	EB1221-SS	40	Ø 40	M10
	EB0321	50	Ø 40	M10
	EB1321	50	Ø 40	M10
	EB0321-SS	50	Ø 40	M10
	EB1321-SS	50	Ø 40	M10
	EB001	50	Ø 50	M10
	EB1331	50	Ø 50	M10
	EB001-SS	50	Ø 50	M10
EB1331-SS	50	Ø 50	M10	

Standard earth bosses include phosphor bronze fixings.
Earth boss part no.s ending '-SS' include stainless steel fixings.

Tower earth clamp

	Part no.	Conductor range (mm ²)	Conductor material
	BN125	16-70	Copper
	BN130	70-120	Copper
	BN300-FU	25-50	Copper
	BN305	25-50	Aluminium
	BN320	120-185	Copper
	BN325	185-240	Copper

B bond

	Part no.	Max tape width (mm)	Conductor material
	BN105	26	Copper
	BN005	26	Aluminium
	BN113	31	Copper
	BN114	40	Copper
	BN117	50	Copper

RWP bond

	Part no.	Max tape width (mm)	Conductor material
	BN115	26	Copper
	BN010	26	Aluminium

Watermain bond

	Part no.	Max tape width (mm)	Conductor material
	BN120	26	Copper

Pipe bond

	Part no.	Conductor diameter (mm)	Pipe diameter (mm)	Conductor material
	BN175	Ø 8	Ø 50-200	Copper
	BN176	Ø 8	Ø 50-200	Aluminium

Pipe clamp

	Part no.	Pipe diameter (in)	Pipe diameter (mm)
	3902	Ø ½-1	Ø 13-25
	3903	Ø 1¼-2	Ø 32-50
	3904	Ø 2½-3½	Ø 65-90
	3905-TB	Ø 4-5	Ø 100-125
	3906-TB	Ø 6	Ø 150
	3907	Ø 8	Ø 200
	3908	Ø 10	Ø 250

Pipe clamps fit 25-95mm² copper conductor.

Earth bonds & clamps

Earth points, splitbolt connector, bonds & clamps

Single hole earth point

Part no.	Hole size (mm)	Length (mm)
PC100-FU	M8 x 15	80
PC101	M10 x 15	80
PC102	M12 x 15	80
PC103	M16 x 15	80

Part no.	Description
PC105	PC100-FU earth point with pre-welded 500 mm earth cable
PC106	PC101 earth point with pre-welded 500 mm earth cable
PC107	PC102 earth point with pre-welded 500 mm earth cable



Two hole earth point

Part no.	Hole size (mm)	Length (mm)
PC115-FU	M8 x 12	80
PC120	M8 x 12	80
PC125	M8 x 12	80

Part no.	Description
PC116	PC115-FU earth point with pre-welded 500 mm earth cable
PC121	PC120 earth point with pre-welded 500 mm earth cable
PC126-FU	PC125 earth point with pre-welded 500 mm earth cable

Part no.	Description
PC216	PC115-FU earth point with pre-welded 2 x 500 mm earth cable
PC221	PC120 earth point with pre-welded 2 x 500 mm earth cable



PC115-FU supplied with front plate for 70 mm² conductor. PC120 supplied with front plate for Ø 8mm solid circular. PC125 supplied without front plate.

Four hole earth point

Part no.	Hole size (mm)	Length (mm)
PC110	M8 x 14	75

Part no.	Description
PC111	PC110-FU earth point with pre-welded 500 mm earth cable

Part no.	Description
PC211	PC110 earth point with pre-welded 2 x 500 mm earth cable



Metalwork bond

Part no.	Conductor diameter (mm)	Conductor material
CS350	Ø 8	Copper
CS355	Ø 8	Aluminium



Type H splitbolt connector

Part no.	Conductor range			
	Main min. (mm ²)	Main max. (mm ²)	Tap min. (mm ²)	Tap max. (mm ²)
8H	4	10	2.5	10
4H	10	16	2.5	16
2H	16	25	4	25
1H	25	35	4	35
10H	35	50	4	50
20H	35	70	4	70
30H	50	95	4	95
40H	50	120	6	120
350M	95	185	6	185



Straight setscrew cable socket

Part no.	Conductor diameter (mm)	Palm hole diameter (mm)	Conductor material
SX450	Ø 8	12	Copper
SX455	Ø 8	12	Aluminium



Earth bonds & clamps

Static earth connection points, flexible braid bonds & static earth clamps

— Eyebolt



Part no.	Nominal copperbond rod diameter (in)
BT150	$\frac{5}{8}$
BT160	$\frac{3}{4}$

— Stainless steel earthing clamp



Part no.	Description	Jaw opening (mm)
SK010	Medium duty earthing clamp	15
SK020	Heavy duty earthing clamp	35

— Static earth receptacle



Part no.	Conductor material
RX005	Copper

— Stainless steel earthing clamp



Part no.	Description	Jaw opening (mm)
SK030	Medium duty earthing clamp & reel	15
SK040	Heavy duty earthing clamp & reel	35

— Flexible flat copper braid



Part no.	Overall braid dimensions (mm)	Length (mm)	Hole diameter (mm)
Copper braid			
FBB-6-200-7	12 x 1	200	Ø 7
FBB-16-200-9	19 x 2.5	200	Ø 9
FBB-25-200-11	25 x 3	200	Ø 11
BN505	25 x 3.5	200	Ø 11
BN510	25 x 3.5	400	Ø 11
FBB-50-200-11	30 x 5	200	Ø 11
FBB-70-200-13	32 x 6	200	Ø 13
FBB-95-200-13	37 x 6	200	Ø 13
FBB-120-200-17	45 x 6	200	Ø 17
Tinned copper braid			
FBB-6-200-7-T	12 x 1	200	Ø 7
FBB-16-200-9-T	19 x 2.5	200	Ø 9
FBB-25-200-11-T	25 x 3	200	Ø 11
BN505-T	25 x 3.5	200	Ø 11
BN510-T	25 x 3.5	400	Ø 11
FBB-50-200-11-T	30 x 5	200	Ø 11
FBB-70-200-13-T	32 x 6	200	Ø 13
FBB-95-200-13-T	37 x 6	200	Ø 13
FBB-120-200-17-T	45 x 6	200	Ø 17

Earth bars

Earth bar & earth bar with single disconnecting link

Earth bar

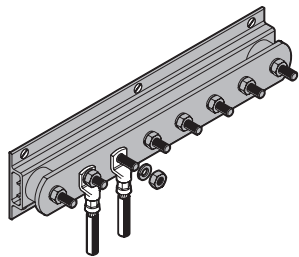

Part no.	Description	Length (mm)
Copper earth bar		
LK245-6	6 way	400
LK245-8	8 way	500
LK245-10	10 way	650
LK245-12	12 way	750
LK245-14	14 way	850
LK245-16	16 way	950
LK245-18	18 way	1,050
LK245-20	20 way	1,200
LK245-22	22 way	1,300
LK245-24	24 way	1,400
LK245-26	26 way	1,500
LK245-28	28 way	1,650
LK245-30	30 way	1,750
Tinned copper earth bar		
LK245-6-T	6 way	400
LK245-8-T	8 way	500
LK245-10-T	10 way	650
LK245-12-T	12 way	750
LK245-14-T	14 way	850
LK245-16-T	16 way	950
LK245-18-T	18 way	1,050
LK245-20-T	20 way	1,200
LK245-22-T	22 way	1,300
LK245-24-T	24 way	1,400
LK245-26-T	26 way	1,500
LK245-28-T	28 way	1,650
LK245-30-T	30 way	1,750

Earth bar with single disconnecting link

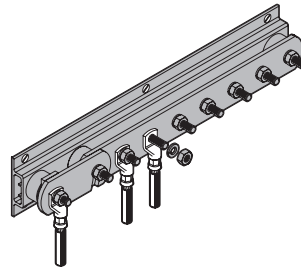

Part no.	Description	Length (mm)
Copper earth bar		
LK243-6	6 way	475
LK243-8	8 way	575
LK243-10	10 way	725
LK243-12	12 way	825
LK243-14	14 way	925
LK243-16	16 way	1,025
LK243-18	18 way	1,125
LK243-20	20 way	1,275
LK243-22	22 way	1,375
LK243-24	24 way	1,475
LK243-26	26 way	1,575
LK243-28	28 way	1,725
LK243-30	30 way	1,825
Tinned copper earth bar		
LK243-6-T	6 way	475
LK243-8-T	8 way	575
LK243-10-T	10 way	725
LK243-12-T	12 way	825
LK243-14-T	14 way	925
LK243-16-T	16 way	1,025
LK243-18-T	18 way	1,125
LK243-20-T	20 way	1,275
LK243-22-T	22 way	1,375
LK243-24-T	24 way	1,475
LK243-26-T	26 way	1,575
LK243-28-T	28 way	1,725
LK243-30-T	30 way	1,825

Earth bars

Earth bar with twin disconnecting link & accessories

Earth bar with twin disconnecting link

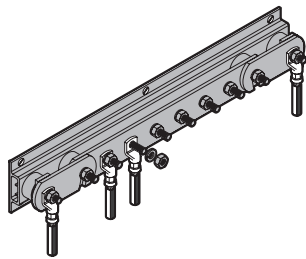

Part no.	Description	Length (mm)
Copper earth bar		
LK207-6	6 way	550
LK207-8	8 way	650
LK207-10	10 way	800
LK207-12	12 way	900
LK207-14	14 way	1,000
LK207-16	16 way	1,100
LK207-18	18 way	1,200
LK207-20	20 way	1,350
LK207-22	22 way	1,450
LK207-24	24 way	1,550
LK207-26	26 way	1,650
LK207-28	28 way	1,800
LK207-30	30 way	1,900



Part no.	Description	Length (mm)
Tinned copper earth bar		
LK207-6-T	6 way	550
LK207-8-T	8 way	650
LK207-10-T	10 way	800
LK207-12-T	12 way	900
LK207-14-T	14 way	1,000
LK207-16-T	16 way	1,100
LK207-18-T	18 way	1,200
LK207-20-T	20 way	1,350
LK207-22-T	22 way	1,450
LK207-24-T	24 way	1,550
LK207-26-T	26 way	1,650
LK207-28-T	28 way	1,800
LK207-30-T	30 way	1,900

Earth bar accessories

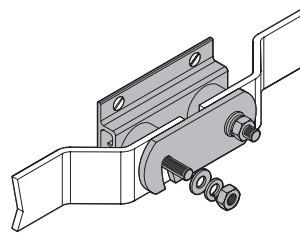

Part no.	Description
Copper earth bar	
LK004	Swan-neck link
LK205	Disconnecting link
Tinned copper earth bar	
LK004-T	Swan-neck link
LK205-T	Disconnecting link

Insulator



Part no.	Height (mm)	Insert size
Insulator		
IN020	20	M6
IN030	30	M6
IN040	40	M8
IN013	50	M10
IN060	60	M10
IN070	70	M12
Insulator with 2 studs and 3 nuts		
IN005	50	M10

FurseWELD

FurseWELD exothermic welding



FurseWELD powders

	Part no.	Box quantity
	15P10	20
	25P10	20
	32P10	20
	45P10	20
	65P10	10
	90P10	10
	115P10	10
	150P10	10
	200P10	10
	250P10	10

FurseWELD handle clamps

	Part no.	Box quantity
	HCPK1	Single part moulds (Price Key 1)
	HCPK2	Single part moulds (Price Key 2)
	HCPK3	Two part moulds (Price Key 3)
	HCPK3-A	With chain grip, two part moulds (Price Key 3)
	HCPK3-B	Sprung, single part moulds (Price Key 3)
	HCPK4	Two-part moulds (Price Key 4)
	HCPK4-A	With chain grip, multi-part moulds (Price Key 4)
	HCPK5	Multi-part moulds (Price Key 5)
HCPK7	Multi-part moulds (Price Key 7)	
HCPK8	Multi-part moulds (Price Key 8)	

FurseWELD high quality graphite moulds are designed to contain the exothermic reaction and to deliver safe, robust welded connections. Each mould is capable of producing up to 75 joints, if not more when properly maintained. For standard connection types, see the following pages.

FurseWELD accessories

	Part no.	Description
	B135	Cable cleaning brush
	BCM	Mould cleaning brush
	BFC	Tape cleaning brush
	DUXSEAL	Duxseal sealing compound (1 lb)
	FGUN	Flint gun
	FLINTS	Replacement flints (pack of 100)
	PACK-A	Packing
	STM1-FU	Mould cleaning scraper
	TB100-FU	Welding toolbox
	TK100	Standard toolkit for bar to bar joints. Includes flint gun (FGUN), tape cleaning brush (BFC), mould cleaning brush and scraper (BCM & STM1-FU)
	TK200	Standard toolkit for cable to cable joints. Includes flint gun (FGUN), cable cleaning brush (B135), mould cleaning brush and scraper (BCM & STM1-FU)
	MJ4	Mould jacket (Price Key 3 & 4)
	MJ5	Mould jacket (Price Key 5)

Sleeves

	Part no.	Description	Conductor size (mm ²)
	S102-FU	Copper sleeve	10
	S103	Copper sleeve	16
	S105	Copper sleeve	2.5 / 4 / 6

FurseWELD

Connection selection guide

—
Bar to bar

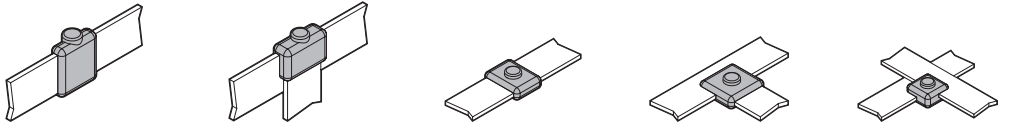

Connection Type	Type BB1	Type BB3	Type BB7	Type BB14	Type BB41
-----------------	----------	----------	----------	-----------	-----------

—
Bar to steel surface

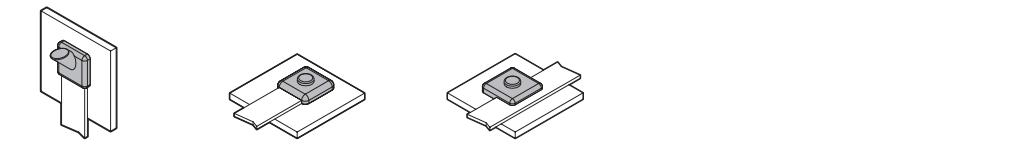

Connection Type	Type BS1	Type BS2	Type BS3
-----------------	----------	----------	----------

—
Bar to earth rod

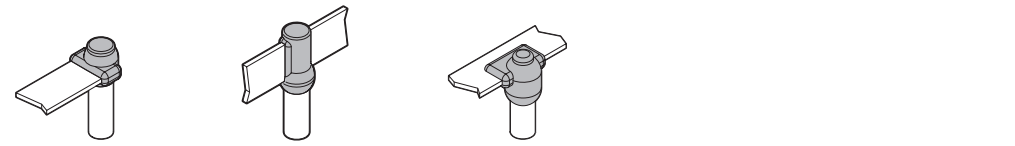

Connection Type	Type BR1	Type BR2	Type BR7
-----------------	----------	----------	----------

—
Cable to bar

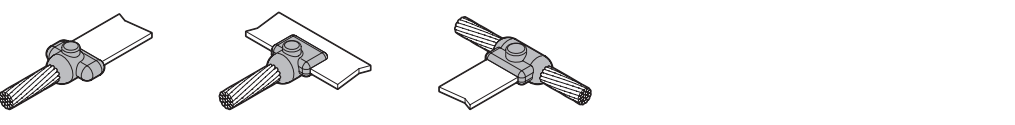

Connection Type	Type CB1	Type CB4	Type CB5
-----------------	----------	----------	----------

—
Cable to cable

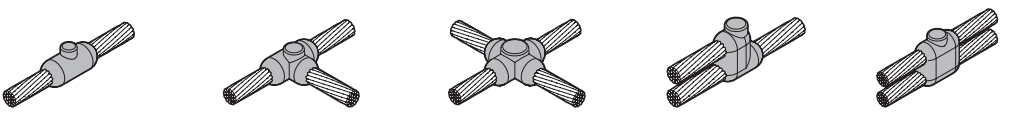

Connection Type	Type CC1	Type CC2	Type CC4	Type CC6	Type CC7
-----------------	----------	----------	----------	----------	----------

—
Cable to cable



Connection Type	Type CC11	Type CC14
-----------------	-----------	-----------

FurseWELD

Connection selection guide

— Cable to earth rod					
Connection Type	Type CR1	Type CR2	Type CR3	Type CR17	Type CR24
— Cable to reinforcing bar					
Connection Type	Type CRE1	Type CRE2	Type CRE3	Type CRE6	Type CRE17
— Cable to steel surface & pipe					
Connection Type	Type CS1	Type CS2	Type CS3	Type CS7	Type CS8
— Cable to steel surface & pipe					
Connection Type	Type CS9	Type CS25	Type CS27	Type CS32	Type CS34
— Stud to steel surface					
Connection Type	Type RS1	Type FS2			

Conductors must be in the orientation shown to achieve the correct connection

Furse offers technical support to assist with selection of joint type. If connections shown do not meet your requirements, please contact your local sales office for assistance.

ABB Furse ESP range of SPDs

Enhanced solutions to BS EN 62305/BS 7671

The Furse ESP range of SPDs (power, data and telecom) are widely specified in all applications to ensure the continuous operation of critical electronic systems. They form part of a complete lightning protection solution to BS EN 62305. Furse ESP M and ESP D power SPD products are Type 1+2+3 devices, making them suitable for installation at the service entrance, whilst giving

superior voltage protection levels (enhanced to BS EN 62305) between all conductors or modes.

The active status indication informs the user of:

- Loss of power
- Loss of phase
- Excessive N-E voltage
- Reduced protection

The SPD and supply status can also be monitored remotely via the volt-free contact.



Protection for 230/400 V TN-S or TN-C-S supplies

Supply type	Example 1	Example 2	Example 3	Example 4
	No external lightning protection system fitted	No external lightning protection system fitted	External lightning protection system fitted	External lightning protection system fitted
	Underground mains supply feed	Exposed overhead mains supply feed	Multiple connected metallic services	No. of services unknown
Main distribution board (MDB)	Type 1+2+3	Type 1+2 OR Type 1+2+3	Type 1+2+3	Type 1+2 OR Type 1+2+3
3 Phase 400 V Service entrance, after electricity meter (Main distribution board (MDB)). Type 1+2+3 SPDs such as the ESP M and D series are used where the MDB directly feeds critical electronics	 ESP 415 D1 Series	 ESP 415 M1 Series	 ESP 415/III/TNS Series	 ESP 415 M2 Series for critical electronics
	OR		OR	
				For LPL I & II: ESP 415 I/TNS Series For LPL I & II: ESP 415 M4 Series LPL III or IV: ESP 415 M2 Series
Sub-distribution board (SDB)	Type 1+2+3			
Located >10 m from MDB feeding electronic equipment	 ESP 240 D1 Series	OR	 ESP 240 M1 Series	OR
				For 3 Phase 400 V ESP 415 D1 Series, or ESP 415 M1 Series
				OR
				For 1 Phase 230 V ESP 240 D1 Series, or ESP 240 M1 Series
Final circuit equipment	For 13 A sockets (e.g. servers)	Fused spurs	Consumer units	
Located >10 m from SDB	 ESP MC ESP MC/TN/RJ11 ESP MC/Cat-5e	 ESP 240D-10A ESP 240D-32A ESP 240T3/SKT	 Furse MMP 2C275/1+1T	

Protection for data signal and telecoms applications



ESP data SPD range overview

Product selector - Data line protection

Fieldbus/ PROFIBUS Systems				Q series also come with Fast fit "screwless" Push Terminals PT - add "/PT" to part code		
HART Systems RS485	ESP RS485 Flat/DIN Mount 7TCA085400R0191	ESP SL RS485 Slim DIN Mount 7TCA085400R0193	ESP RS485Q Multiple Lines (DIN Mount) 7TCA085400R0192			
Ethernet		Cat-5 (100 Mbps) ESP Cat-5e 7TCA085400R0017	ESP Cat-5e/PoE 7TCA085400R0021	Cat-6 (1000 Mbps) ESP Cat-6 7TCA085400R0023	ESP Cat-6/PoE 7TCA085400R0024	
Video Surveillance						
CCTV	5V CCTV with BNC connector, power, and telemetry line	ESP CCTV/B Video signal 7TCA085400R0123	ESP RS485 Telemetry signal 7TCA085400R0191	ESP 240-16A Power line 7TCA085460R0080	ESP CME4 Earth Bar 7TCA085400R0001	ESP WBX4/GS Enclosure 7TCA085410R0028
4 - 20 mA current loops			Product code: 7TCA085400R0070			
Coaxial antennas: GSM, UMTS, Radar, Radio, TV, GPS		RF power = 650 W Female coaxial connector:	ESP RF 441421 BNC 7TCA085450R0058	ESP RF AA1421 7/16 DIN 7TCA085450R0061	ESP RF 111421 N 7TCA085450R0005	
Telephone ISDN DSL G.FAST		Screw terminals:				
			ESP TN Flat Mount 7TCA085400R0171	ESP SL TN Slim Mount 7TCA085400R0195	ESP SL TNL Slim Mount with LED 7TCA085400R0226	ESP TNQ Multiple Lines 7TCA085400R0183
		RJ11, RJ45	RJ11 telephone units	ESP TN/RJ11-6/6 6P6C Connector 7TCA085400R0180	RJ45 network units	ESP ISDN/RJ45-4/8 8P4C Connector 7TCA085460R0171
		PBX Telecom	LSA-PLUS connection	ESP KT1 Single module 7TCA085400R0135	ESP K10T1 10 modules 7TCA085400R0130	ESP KE10 Earth Bar 7TCA085400R0134
TV: Satellite, Cable		ESP CATV/F Cable 7TCA085400R0122	ESP SMATV/F Satellite 7TCA085450R0026	ESP TV/EURO Antenna 7TCA085450R0027		
2 wire systems (30 V)		ESP 30E Flat Mount 7TCA085400R0104		ESP SL30 Slim Mount 7TCA085400R0067		ESP 30Q Multiple Lines 7TCA085400R0107
					Protection for different voltages are available	Q series also come with Fast fit "screwless" Push Terminals PT - add "/PT" to part code
Hazardous Areas ATEX/IEC Approved		ESP SL15X 15 Volt 7TCA085400R0065	ESP SL30X 30 Volt 7TCA085400R0071			LED and Isolated base options are available
Resistance Temperature Detectors (RTD) 3 wire systems		ESP RTD Flat/DIN Mount 7TCA085460R0157		ESP SL RTD Slim (DIN Mount) 7TCA085400R0232		ESP RTDQ Multiple Lines (DIN Mount) 7TCA085400R0158
					Q series also come with Fast fit "screwless" Push Terminals PT - add "/PT" to part code	
3 wire systems (30 V)		ESP SL30/3W Slim Mount 7TCA085400R0268	Protection for different voltages are available			
			IMPORTANT: Equipment is ONLY protected against transient overvoltages if all incoming / outgoing mains and data lines have protection fitted.			

Electronic systems protection

Surge protection devices (SPDs) for mains power supplies

Mains supplies - equipotential bonding

	Part no.	Description
	ESP 240/I/TNS	Enhanced Type 1+2 power SPD for Single Phase 240V TNS supplies, 50kA 10/350
	ESP 240/III/TNS	Enhanced Type 1+2 power SPD for Single Phase 240V TNS supplies, 25kA 10/350
	ESP 240 /I/TT	Enhanced Type 1+2 power SPD for Single Phase 240V TT supplies, 50kA 10/350
	ESP 240/III/TT	Enhanced Type 1+2 power SPD for Single Phase 240V TT supplies, 25kA 10/350
	ESP 415/I/TNS	Enhanced Type 1+2 power SPD for Three Phase 415V TNS supplies, 25kA 10/350
	ESP415/III/TNS	Enhanced Type 1+2 power SPD for Three Phase 415V TNS supplies, 12.5kA 10/350
	ESP415/I/TT	Enhanced Type 1+2 power SPD for Three Phase 415V TT supplies, 25kA 10/350
	ESP415/III/TT	Enhanced Type 1+2 power SPD for Three Phase 415V TT supplies, 12.5kA 10/350

Mains supplies - DIN housing

	Part no.	Description
	ESP 240 D1	Enhanced Type 1+2+3 Full Mode power SPD for 240V Single Phase supplies, Din Rail mounted
	ESP 415 D1	Enhanced Type 1+2+3 Full Mode power SPD for 415V 3 Phase supplies, Din Rail mounted
	Supplied with remote indication display	
	ESP 415 D1R	Enhanced Type 1+2+3 Full Mode power SPD for 3 Phase 415V supplies, LED status indication on remote display, Din Rail mounting
	ESP RLA HD-4	4 Metre display lead for ESP D1R Series

Mains supplies (extra high maximum surge currents)

	Part no.	Description
	ESP 415 M2	Enhanced Type 1+2+3 Full Mode power SPD for 3 Phase 415V supplies, high surge current rating
	ESP 415 M4	Enhanced Type 1+2+3 Full Mode power SPD for 3 Phase 415V supplies, very high surge current rating

Mains supplies & power distribution system

	Part no.	Description
	ESP 240 M1	Enhanced Type 1+2+3 power SPD for 240V Single Phase supplies
	ESP 415 M1	Enhanced Type 1+2+3 power SPD for 415V 3 Phase supplies

Electronic systems protection

Surge protection devices (SPDs) for mains power supplies

Mains supplies - with remote display indication



Part no.	Description
ESP 415 M1R	Enhanced Type 1+2+3 power SPD for 3 Phase 415V supplies, with remote indication display
ESP 415 M2R	Enhanced Type 1+2+3 power SPD for 3 Phase 415V supplies, 12.5KA 10/350, with remote indication display
ESP 415 M4R	Enhanced Type 1+2+3 power SPD for 3 Phase 415V supplies, 25KA 10/350, with remote indication display
ESP RLA-4	4 Metre display lead for ESP M1R, M2R and M4R Series

Mains supplies & fused connections up to 10 amps or up to 32 amps



Part no.	Description
Protectors rated at 10 amps or less	
ESP 240D-10A	Enhanced mains SPD for 240V supplies up to 10A, with LED status indication
ESP 240DS-10A	Enhanced mains SPD for 240V supplies up to 10A, with LED status indication and remote signal contact
Protectors rated at 32 amps or less	
ESP 240D-32A	Enhanced mains SPD for 240V supplies up to 32A, with LED status indication
ESP 240DS-32A	Enhanced mains SPD for 240V supplies up to 32A, with LED status indication and remote signal contact

Mains supplies & fused connections up to 5 amps or up to 16 amps



Part no.	Description
Protectors rated at 5 amps or less	
ESP 240-5A	Enhanced mains SPD for 240V supplies up to 5A
ESP 240-5A/BX	Enhanced mains SPD for 240V supplies up to 5A, IP66 enclosure
Protectors rated at 16 amps or less	
ESP 240-16A	Enhanced mains SPD for 240V supplies up to 16A
ESP 240-16A/BX	Enhanced mains SPD for 240V supplies up to 16A, IP66 enclosure
ESP 240T3/SKT	Type 3 mains SPD for supplies up to 16A for installation behind socket outlets

Plug-in SPD for mains power supplies, with telephone and computer line protection options



Part no.	Description
ESP MC/19BK	Brackets and fixings for mounting ESP MC SPD Series To 19" racks
ESP MC	Plug-in power SPD with filtering for 220-240V systems up to 13A with UK plug
ESP MC/TN/RJ11	Plug-in power SPD with filtering for 220-240V systems up to 13A with UK plug and data SPD for telecom systems with RJ11 connection
ESP MC/Cat-5e	Plug-in power SPD with filtering for 220-240V systems up to 13A with UK plug and data SPD for Cat-5E computer systems with RJ45 connection

Electronic systems protection

Surge protection devices (SPDs) for data, signal and telephone lines

Twisted pair data communication & signal lines (lower in-line resistance, higher current and higher bandwidth)



Part no.	Description
ESP 06E	Data SPD for 2-Wire signal lines up to 6V, 1.25A
ESP 15E	Data SPD for 2-Wire signal lines up to 15V, 1.25A
ESP 30E	Data SPD for 2-Wire signal lines up to 30V, 1.25A
ESP 50E	Data SPD for 2-Wire signal lines up to 50V, 1.25A
ESP 110E	Data SPD for 2-Wire signal lines up to 110V, 1.25A

Twisted pair data communication, signal & telecom lines - slim line, with removable protection module



Part no.	Description
ESP SLTN	Data SPD for 2-Wire telephone lines up to 296V (ringing voltage)
Slim line protectors with removable protection module, LED status indication and isolated screen	
ESP SL06L/I	Data SPD for 2-Wire signal lines up to 6V, 750mA
ESP SL15L/I	Data SPD for 2-Wire signal lines up to 15V, 750mA
ESP SL30L/I	Data SPD for 2-Wire signal lines up to 30V, 750mA
ESP SL50L/I	Data SPD for 2-Wire signal lines up to 50V, 750mA
ESP SL110L/I	Data SPD for 2-Wire signal lines up to 110V, 750mA
Slim line, Intrinsically Safe protectors (ATEX approved) with removable protection module, LED status indication and isolated screen	
ESP SL15XL/I	Data SPD for 2-Wire signal lines up to 15V, 750mA
ESP SL30XL/I	Data SPD for 2-Wire signal lines up to 30V, 750mA
Slim line SPD for 4-20mA current loops with removable protection module, LED status indication and isolated screen	
ESP SL30L/4-20/I	Data SPD for 4-20mA signal lines up to 30V, 75mA

High density data, signal & telephone lines (/PT fast fit Push Terminal option)



Part no.	Description
ESP 06Q or ESP 06Q/PT	Data SPD for 8-Wire (4 pairs) 6V signal lines space saving design
ESP 15Q or ESP 15Q/PT	Data SPD for 8-Wire (4 pairs) 15V signal lines space saving design
ESP 30Q or ESP 30Q/PT	Data SPD for 8-Wire (4 pairs) 30V signal lines space saving design
ESP 50Q or ESP 50Q/PT	Data SPD for 8-Wire (4 pairs) 50V signal lines space saving design
ESP 110Q or ESP 110Q/PT	Data SPD for 8-Wire (4 pairs) 110V signal lines space saving design
ESP 180Q or ESP 180Q/PT	Data SPD for 8-Wire (4 pairs) 180V signal lines space saving design
ESP TNQ or ESP TNQ/PT	Data SPD for 4 twisted pair phone lines with a maximum (ringing) voltage of 296 volts

Three wire RTD applications



Part no.	Description
ESP RTD	Data SPD for three 3-Wire RTD systems
ESP SL RTD	Slim Line Data SPD for 3-Wire RTD systems
ESP RTDQ ESP RTDQ/PT	Data SPD for three of 3-Wire RTD systems space saving design

RS485 & Fieldbus applications



Part no.	Description
ESP RS485	Data SPD for RS485 signalling systems
ESP SL RS485	Slim Line Data SPD for RS485 signal lines
ESP RS485Q ESP RS485Q/PT	Data SPD for 8-Wire (4 pairs) RS485 signal lines space saving design

Electronic systems protection

Surge protection devices (SPDs) for computer and telephone lines

Plug-in protectors for telephone & ISDN lines



Part no.	Description
ESP TN/JP	Data SPD for telephone line with BT UK connection
ESP TN/RJ11-6/6	Data SPD for 6-Wire telephone line with RJ11 connection
ESP ISDN/RJ45-8/8	Data SPD for 8-Wire ISDN telephone line, RJ45 connector

PSTN & ISDN telephone lines with LSA-PLUS connections

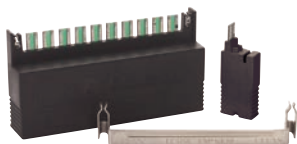

Part no.	Description
ESP KE10	Earth connection bar for up to 10 of ESP KT1 data SPDs for LSA-PLUS PBX systems
ESP KT1	Data SPD for one LSA-PLUS PBX phone line, use with ESP KE10 earth bar
ESP K10T1	Data SPD for 10 LSA-PLUS PBX telephone lines

Computer networks up to Cat-6 cabling & PoE+



Part no.	Description
ESP Cat-6	Data SPD for Cat-6 1000 Base T computer networks, RJ45 connector
ESP Cat-6/PoE	Data SPD for Cat-6 1000 Base T computer networks with Power over Ethernet, RJ45 connector

Electronic systems protection

Surge protection devices (SPDs) for specific systems

Mains supplies - wind turbine (WT) power distribution systems



Part no.	Description
ESP 690/25/WT	Type 1+2 power SPD for wind turbine systems, 25kA 10/350
ESP 690/12.5/WT	Type 1+2 power SPD for wind turbine systems, 12.5kA 10/350
ESP CE7	Connection and earthing bar for use with 3 of ESP 690/12.5/WT protectors for TNC systems
ESP CE9	Connection and earthing bar for use with 4 of ESP 690/12.5/WT protectors for TNS systems
ESP CE10	Connection and earthing bar for use with 3 of ESP 690/25/WT protectors for TNC systems
ESP CE13	Connection and earthing bar for use with 4 of ESP 690/25/WT protectors for TNS systems

DC photo-voltaic (PV) power distribution systems



Part no.	Description
ESP DC1000/12.5/PV	Type 1+2 power SPD for 1000Vdc PV supplies, 12.5kA 10/350 surge current rating
ESP DC550/12.5/PV	Type 1+2 power SPD for 550Vdc PV supplies, 12.5kA 10/350 surge current rating

Coaxial cable TV (CATV) systems



Part no.	Description
ESP CATV/F	Data SPD for Cable TV 5-860Mhz with F Type connector
ESP TV/F	Data SPD for TV 5-860Mhz with F Type connector
ESP TV/EURO	Data SPD for TV 5-860Mhz with Euro-TV connector
ESP MATV/F	Data SPD for main antenna TV MATV 5-2450Mhz with F Type connector
ESP SMATV/F	Data SPD for satellite main antenna TV SMATV 860-2450Mhz with F Type connector

Closed circuit TV video lines



Part no.	Description
ESP CCTV/B	Data SPD for CCTV systems with BNC connection for Coax cable
ESP CCTV/T	Data SPD for CCTV systems with twisted pair cables

Coaxial RF systems (for frequencies between DC and 2.7 GHz)



Part no.	Description
ESP RF 111421	RF Data SPD high performance N Type connection
ESP RF AA1421	RF Data SPD 350V GDT with 7/16 Din connection
ESP RF 441421	RF Data SPD 350V GDT with BNC connection

Higher performance coaxial RF systems (for frequencies between 50 MHz and 2.7 GHz)



Part no.	Description
ESP RF 111A11	RF Data SPD high performance N Type connection
ESP RF AA1A11	RF Data SPD high performance 7/16 Din connection
ESP RF 441A11	RF Data SPD high performance BNC connection

Electronic systems protection

Accessories

Weatherproof enclosures



Part no.	Description
WBX 2/G	IP66 Enclosure for 2 single stud ESP D/E/H data SPDs or ESP TN telecom SPD, grey lid
WBX 3	IP67 Enclosure for 3 single stud data SPDs or ESP Single Phase M1 mains SPD, clear lid
WBX 3/G	IP67 Enclosure for 3 single stud data SPDs, grey lid
WBX 4	IP66 Enclosure for ESP 415 M1, ESP 208 M1 or ESP 480 M1 or 4 single stud ESP data/telecom
WBX 4/GS	IP66 Enclosure for 4 single stud ESP data/telecom SPDs using CME4 earth bar, grey lid, security screws
WBX 8	IP66 Enclosure for 8 single stud ESP data/telecom SPDs using CME8 earth bar, grey lid
WBX 8/GS	IP66 Enclosure for 8 single stud ESP data/telecom SPDs using CME8 earth bar, grey lid, security screws
WBX 16/2/G	IP56 Enclosure for 1 or 2 CME16 earth bars for mounting and enclosing up to
WBX D4	IP65 Enclosure for 72mm DIN (4TE)
WBX D8	IP65 Enclosure for 144mm DIN (8TE)
WBX M2	IP67 Enclosure for ESP 415 M2 or ESP 480 M2, clear lid
WBX M4	IP67 Enclosure for ESP 415 M2 or ESP 480 M2, clear lid
WBX SLQ	IP66 Enclosure for up to 15 of ESP SL Series, or up to 6 of ESP Q Series, clear lid
WBX SLQ/G	IP66 Enclosure for up to 15 of ESP SL Series, or up to 6 of ESP Q Series, grey lid

Combined mounting & earthing kits



Part no.	Description
CME 4	4 Hole combined mounting earthing kit
CME 8	8 Hole combined mounting earthing kit
CME 16	16 Hole combined mounting earthing kit
CME 32	32 Hole combined mounting earthing kit

ABB SPD order code index

Part no.	Order code	Part no.	Order code	Part no.	Order code	Part no.	Order code
CME 16	7TCA085410R0002	ESP 30Q	7TCA085400R0107	ESP DC550/12.5/PV	7TCA085460R0147	ESP SL15XL/I	7TCA085400R0235
CME 32	7TCA085410R0003	ESP 30Q/PT	7TCA085400R0476	ESP ISDN/RJ45-8/8	7TCA085460R0171	ESP SL30L/4-20/I	7TCA085400R0237
CME 4	7TCA085400R0001	ESP 415 D1	7TCA085460R0105	ESP K10T1	7TCA085400R0130	ESP SL30L/I	7TCA085400R0234
CME 8	7TCA085400R0002	ESP 415 D1R	7TCA085460R0107	ESP KE10	7TCA085400R0134	ESP SL30XL/I	7TCA085400R0236
ESP 06E	7TCA085400R0084	ESP 415 M1	7TCA085460R0112	ESP KT1	7TCA085400R0135	ESP SL50L/I	7TCA085400R0201
ESP 06Q	7TCA085400R0087	ESP 415 M2	7TCA085460R0119	ESP MATV/F	7TCA085450R0000	ESP SLTN	7TCA085400R0195
ESP 06Q/PT	7TCA085400R0473	ESP 415 M4	7TCA085460R0124	ESP MC	7TCA085430R0003	ESP SMATV/F	7TCA085450R0026
ESP 110E	7TCA085400R0007	ESP 415/I/TNS	7TCA085460R0101	ESP MC/19BK	7TCA085460R0034	ESP TN/JP	7TCA085400R0177
ESP 110Q	7TCA085400R0088	ESP 415/I/TT	7TCA085460R0102	ESP MC/CAT-5E	7TCA085430R0004	ESP TN/RJ11-6/6	7TCA085400R0180
ESP 110Q/PT	7TCA085400R0478	ESP 415/III/TNS	7TCA085460R0103	ESP MC/TN/RJ11	7TCA085430R0005	ESP TV/EURO	7TCA085450R0027
ESP 15E	7TCA085400R0095	ESP 415/III/TT	7TCA085460R0026	ESP RF 111421	7TCA085450R0005	ESP TV/F	7TCA085450R0028
ESP 15Q	7TCA085400R0098	ESP 415M1R	7TCA085460R0115	ESP RF 111A11	7TCA085450R0007	ESP RTDQ/PT	7TCA085400R0488
ESP 15Q/PT	7TCA085400R0474	ESP 415M2R	7TCA085460R0123	ESP RF 441421	7TCA085450R0058	MMP 2C275/1+1T	7TCA085460R0185
ESP 240 D1	7TCA085460R0086	ESP 415M4R	7TCA085460R0126	ESP RF 441A11	7TCA085450R0014	WBX 16/2/G	7TCA085410R0020
ESP 240 M1	7TCA085460R0089	ESP 50E	7TCA085400R0116	ESP RF AA1421	7TCA085450R0061	WBX 2/G	7TCA085410R0022
ESP 240/I/TNS	7TCA085460R0019	ESP 50Q	7TCA085400R0118	ESP RF AA1A11	7TCA085450R0016	WBX 3	7TCA085410R0023
ESP 240/I/TT	7TCA085460R0020	ESP 50Q/PT	7TCA085400R0477	ESP RLA HD-4	7TCA085460R0156	WBX 3/G	7TCA085410R0024
ESP 240/III/TNS	7TCA085460R0023	ESP 690/12.5/WT	7TCA085460R0308	ESP RLA-4	7TCA085460R0155	WBX 4	7TCA085410R0027
ESP 240/III/TT	7TCA085460R0023	ESP 690/25/WT	7TCA085460R0309	ESP RS485	7TCA085400R0191	WBX 4/GS	7TCA085410R0028
ESP 240-16A	7TCA085460R0080	ESP Cat-6	7TCA085400R0023	ESP RS485Q	7TCA085400R0192	WBX 8	7TCA085410R0030
ESP 240-16A/BX	7TCA085460R0081	ESP Cat-6/PoE	7TCA085400R0024	ESP RS485Q/PT	7TCA085400R0475	WBX 8/GS	7TCA085410R0031
ESP 240-5A	7TCA085460R0083	ESP CATV/F	7TCA085400R0122	ESP RTD	7TCA085460R0157	WBX D4	7TCA085410R0032
ESP 240-5A/BX	7TCA085460R0084	ESP CCTV/B	7TCA085400R0123	ESP RTDQ	7TCA085400R0158	WBX D8	7TCA085410R0033
ESP 240D-10A	7TCA085460R0323	ESP CCTV/T	7TCA085400R0129	ESP RTDQ/PT	7TCA085400R0488	WBX M2	7TCA085410R0034
ESP 240D-32A	7TCA085460R0322	ESP CE10	7TCA085460R0030	ESP SL RS485	7TCA085400R0193	WBX M4	7TCA085410R0035
ESP 240DS-10A	7TCA085460R0317	ESP CE13	7TCA085460R0031	ESP SL RTD	7TCA085400R0232	WBX SLQ	7TCA085410R0037
ESP 240DS-32A	7TCA085460R0318	ESP CE7	7TCA085460R0032	ESP SL06L/I	7TCA085400R0280	WBX SLQ/G	7TCA085410R0036
ESP 240T3/SKT	7TCA085450R0069	ESP CE9	7TCA085460R0033	ESP SL110L/I	7TCA085400R0284		
ESP 30E	7TCA085400R0104	ESP DC1000/12.5/PV	7TCA085460R0146	ESP SL15L/I	7TCA085400R0064		



ABB Furse

Electrification

Wilford Road

Nottingham, UK

NG2 1EB

Tel: +44 (0) 115 964 3700

Fax: +44 (0) 115 986 0071

E-mail: enquiry@furse.com

www.furse.com

