

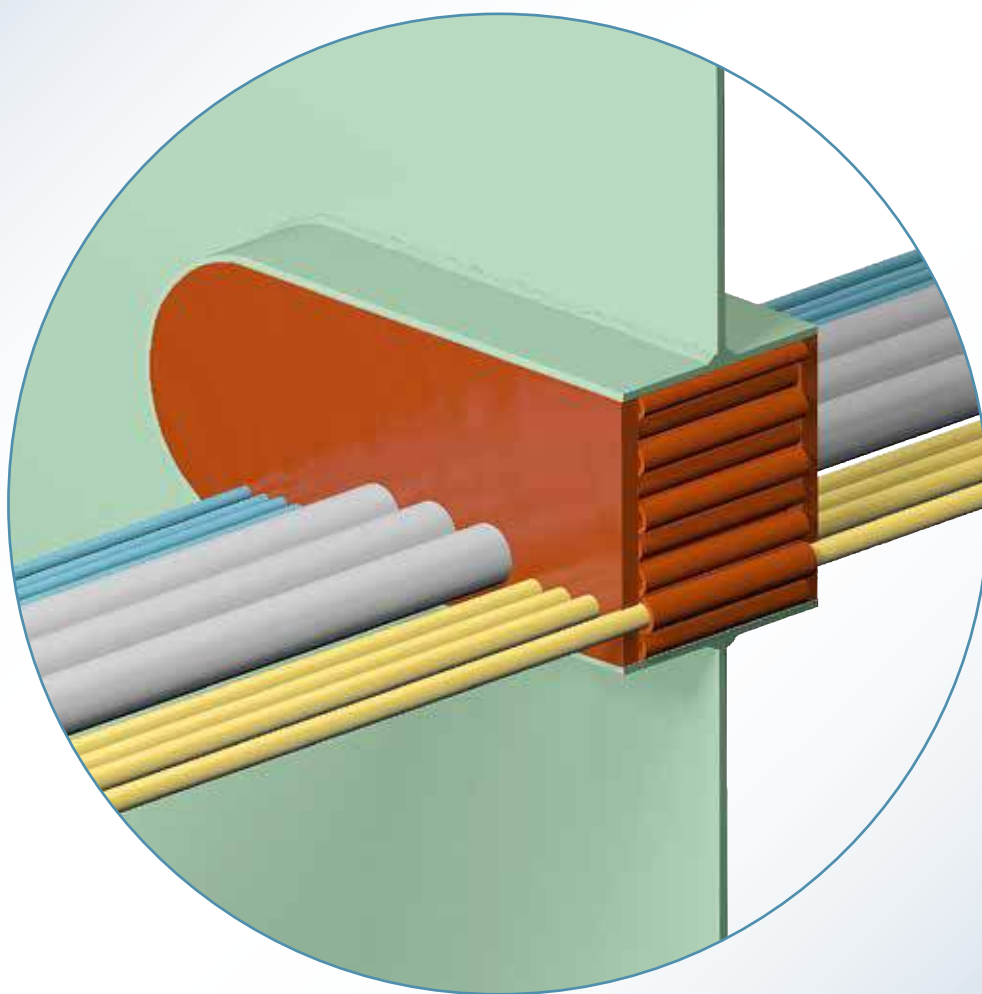

INSTALLATION INSTRUCTIONS NOFIRNO[®] SEALING SYSTEM (NOFIRNO[®] SLEEVES/SEALANT) FOR (MULTI-) CABLE TRANSITS



NO FIRNO[®]

Beele campus 45.000 m²
Construction phase 1 ready March 2020

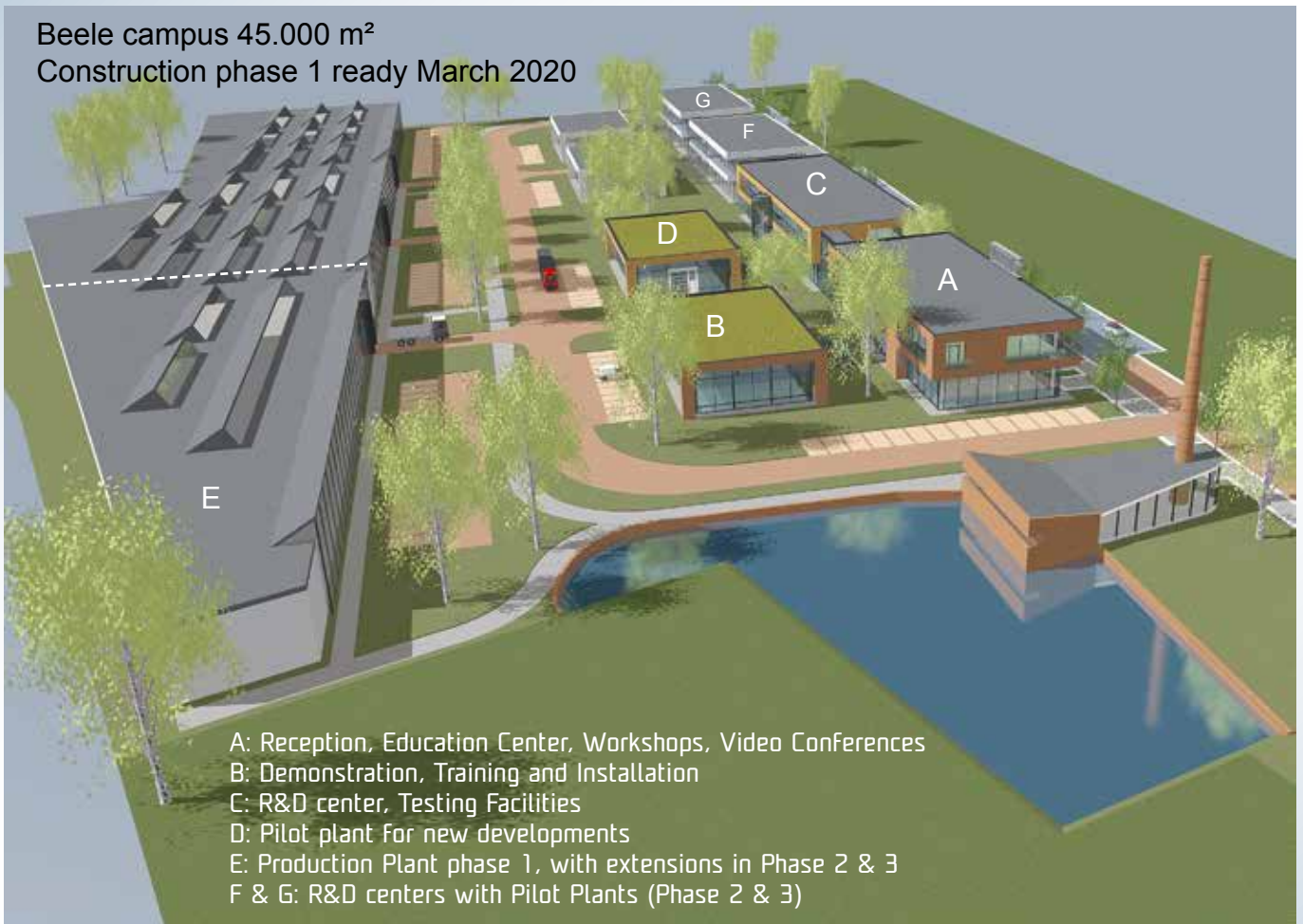

- A: Reception, Education Center, Workshops, Video Conferences
- B: Demonstration, Training and Installation
- C: R&D center, Testing Facilities
- D: Pilot plant for new developments
- E: Production Plant phase 1, with extensions in Phase 2 & 3
- F & G: R&D centers with Pilot Plants (Phase 2 & 3)

Copyright	: BEELE Engineering BV/CSD International BV, Aalten, the Netherlands. Proprietary rights on all drawings and technical data released in this brochure. © 1997-2019
Edition	: February 2020
Note	: No part of this publication may be reproduced without explicit written approval of BEELE Engineering BV.
Research & Development	: BEELE Engineering BV, Aalten, the Netherlands.
Note	: The manufacturer reserves the right to make dimensional and design modifications without prior notification.
®	: ACTIFOAM, AQUASTOP, BEEBLOCK, BEEBOND, BEELE, BEELE WE CARE, BEESEAL, CONDUCTON, CONTITITE, CONTROFIL, CRUSHER, CRUSHNOF, CSD, CSD THE SIMPLE SEAL SYSTEM, DRIFIL, DYNATITE, FIRAQUA, FIREQUAKE, FIRSTO, FISSIC, FIWA, FYLLOFYS, GLANDMOD, LEAXEAL, MULTI-ALL-MIX, NOFIRNO, profiles NOFIRNO gaskets, RAPID TRANSIT SYSTEM, RIACNOF, RISE, RISWAT, SEALING VALLEY, \$, SLIPSIL, flanges SLIPSIL plugs, ULEPSI, XATTAX and YFESTOS are registered trade marks of BEELE Engineering.
brochure code	: installation NOFIRNO cable

INSTALLATION INSTRUCTIONS FOR NOFIRNO® MULTI-CABLE TRANSIT SEALING SYSTEM



Not only for standard cellulose fires, but also for applications with highest fire and tightness ratings (up to HC and Jet Fires) the NOFIRNO® sealing system is used. The NOFIRNO® multi-cable transit sealing system is composed of NOFIRNO® insert (cable) sleeves in 29 different sizes, NOFIRNO® (multi-) filler sleeves in 5 different sizes and NOFIRNO® sealant.

The use of NOFIRNO® multi-filler sleeves contributes to ease of installation.

INSTALLATION INSTRUCTIONS FOR NOFIRNO® MULTI-CABLE TRANSIT SEALING SYSTEM

PRODUCT INFORMATION SEALANT

01) colour	red brown
02) specific gravity	1.40 ± 0.03 g/cm ³
03) curing of top layer	0.5 - 1 hour depending on temperature and air humidity
04) service temperature	-50 °C up to +180 °C
05) tensile strength	1.5 MPa
06) elongation at break	200%
07) hardness	45 Shore A
08) elastic deformation	approx. 50%
09) resistance	UV, Ozone, arctic conditions
10) ageing	more than 20 years
11) supplied in	310 ml cartridges
12) storage	to be stored cool and dry min/max temperature = +5/+30° C
13) storage life	guaranteed 6 months; when applied later than 6 months after date of manufacturing, curing and adhesive properties have to be checked before application

NOFIRNO® is absolutely HALOGEN FREE with zero VOC (volatiles organic compounds) according to TÜV report 89206405-01. Furthermore NOFIRNO® has a low smoke index and a high oxygen index (ISO 4589-2: 1996), and low flame spread characteristics according to IMO Resolution A.653(16). NOFIRNO® is a paste-like compound which is simple to use. NOFIRNO® has a balanced viscosity and can be applied overhead.



terracotta



black



white



blue grey



INSTALLATION INSTRUCTIONS FOR NOFIRNO® MULTI-CABLE TRANSIT SEALING SYSTEM

NOFIRNO® CABLE INSERT SLEEVES



cable insert sleeves are split lengthwise

Operating temperatures:
-50 °C up to +180 °C

NOFIRNO® cable insert sleeves are used to separate cables inside the conduit opening. This allows for ease of application of the NOFIRNO® sealant in between and around the ducted cables. The NOFIRNO® cable sleeves are available in 29 sizes and in lengths of 60, 80, 110, 130, 140, 160 and 210 mm. The NOFIRNO® cable insert sleeves are split lengthwise and can therefore be placed around the cables in front of the conduit opening.

INSTALLATION INSTRUCTIONS FOR NOFIRNO® MULTI-CABLE TRANSIT SEALING SYSTEM

NOFIRNO® CABLE INSERT SLEEVES

NOFIRNO® sleeve	cable diameter	sleeve length	article number	sleeve length	article number	sleeve length	article number	sleeve length	article number
12/6	5 - 7	60 <small>all dimensions in mm</small>	50.1000	80 <small>all dimensions in mm</small>	50.1240	110 <small>all dimensions in mm</small>	50.1040	130 <small>all dimensions in mm</small>	50.1200
14/8	7 - 9		50.1001		50.1241		50.1041		50.1201
16/10	9 - 11		50.1002		50.1242		50.1042		50.1202
18/12	11 - 13		50.1003		50.1243		50.1043		50.1203
20/14	13 - 15		50.1004		50.1244		50.1044		50.1204
22/16	15 - 17		50.1005		50.1245		50.1045		50.1205
26/18	17 - 19		50.1006		50.1246		50.1046		50.1206
28/20	19 - 21		50.1007		50.1247		50.1047		50.1207
30/22	21 - 23		50.1008		50.1248		50.1048		50.1208
32/24	23 - 25		50.1009		50.1249		50.1049		50.1209
34/26	25 - 27		50.1010		50.1250		50.1050		50.1210
36/28	27 - 29		50.1011		50.1251		50.1051		50.1211
38/30	29 - 32		50.1012		50.1252		50.1052		50.1212
42/33	32 - 35		50.1013		50.1253		50.1053		50.1213
46/36	35 - 38		50.1014		50.1254		50.1054		50.1214
49/39	38 - 41		50.1015		50.1255		50.1055		50.1215
52/42	41 - 44		50.1016		50.1256		50.1056		50.1216
55/45	44 - 47		50.1017		50.1257		50.1057		50.1217
58/48	47 - 51		50.1018		50.1258		50.1058		50.1218
62/52	51 - 55		50.1019		50.1259		50.1059		50.1219
66/56	55 - 59		50.1020		50.1260		50.1060		50.1220
70/60	59 - 63		50.1021		50.1261		50.1061		50.1221
74/64	63 - 67		50.1022		50.1262		50.1062		50.1222
78/68	67 - 71		50.1023		50.1263		50.1063		50.1223
82/72	71 - 75		50.1024		50.1264		50.1064		50.1224
86/76	75 - 79		50.1025		50.1265		50.1065		50.1225
95/80	79 - 84		50.1026		50.1266		50.1066		50.1226
100/85	84 - 89		50.1027		50.1267		50.1067		50.1227
110/90	89 - 94		50.1028		50.1268		50.1068		50.1228
115/95	94 - 99		50.1029		50.1269		50.1069		50.1229
120/100	99 - 104		50.1030		50.1270		50.1070		50.1230

NOFIRNO® sleeve	cable diameter	sleeve length	article number	sleeve length	article number	sleeve length	article number	sleeve length	article number
12/6	5 - 7	140 <small>all dimensions in mm</small>	50.1080	160 <small>all dimensions in mm</small>	50.1120	210 <small>all dimensions in mm</small>	50.1160		
14/8	7 - 9		50.1081		50.1121		50.1161		
16/10	9 - 11		50.1082		50.1122		50.1162		
18/12	11 - 13		50.1083		50.1123		50.1163		
20/14	13 - 15		50.1084		50.1124		50.1164		
22/16	15 - 17		50.1085		50.1125		50.1165		
26/18	17 - 19		50.1086		50.1126		50.1166		
28/20	19 - 21		50.1087		50.1127		50.1167		
30/22	21 - 23		50.1088		50.1128		50.1168		
32/24	23 - 25		50.1089		50.1129		50.1169		
34/26	25 - 27		50.1090		50.1130		50.1170		
36/28	27 - 29		50.1091		50.1131		50.1171		
38/30	29 - 32		50.1092		50.1132		50.1172		
42/33	32 - 35		50.1093		50.1133		50.1173		
46/36	35 - 38		50.1094		50.1134		50.1174		
49/39	38 - 41		50.1095		50.1135		50.1175		
52/42	41 - 44		50.1096		50.1136		50.1176		
55/45	44 - 47		50.1097		50.1137		50.1177		
58/48	47 - 51		50.1098		50.1138		50.1178		
62/52	51 - 55		50.1099		50.1139		50.1179		
66/56	55 - 59		50.1100		50.1140		50.1180		
70/60	59 - 63		50.1101		50.1141		50.1181		
74/64	63 - 67		50.1102		50.1142		50.1182		
78/68	67 - 71		50.1103		50.1143		50.1183		
82/72	71 - 75		50.1104		50.1144		50.1184		
86/76	75 - 79		50.1105		50.1145		50.1185		
95/80	79 - 84		50.1106		50.1146		50.1186		
100/85	84 - 89		50.1107		50.1147		50.1187		
110/90	89 - 94		50.1108		50.1148		50.1188		
115/95	94 - 99		50.1109		50.1149		50.1189		
120/100	99 - 104		50.1110		50.1150		50.1190		

INSTALLATION INSTRUCTIONS FOR NOFIRNO® MULTI-CABLE TRANSIT SEALING SYSTEM

NOFIRNO® MULTI-FILLER SLEEVES

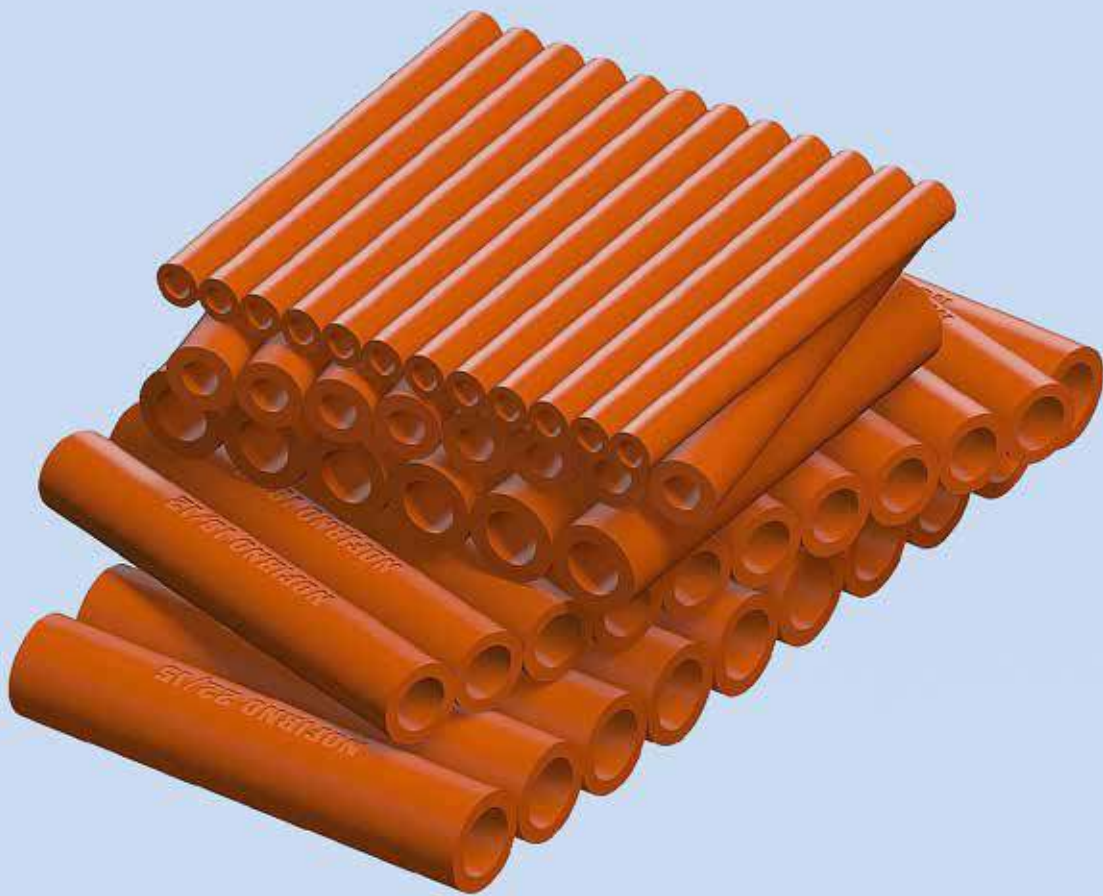

filler sleeves are not split lengthwise

Operating temperatures:
-50 °C up to +180 °C

NOFIRNO® filler sleeves are supplied in multi-sets of 6, 8, 10 and 12 sleeves, depending on the outer dimensions of the sleeves. Single sleeves or smaller sets of sleeves can be torn off easily. To tear off sleeves from the multi-set, the procedure is to do this backwards/forwards and not sideways. This is because of the strength of the intermediate rubber parts.

INSTALLATION INSTRUCTIONS FOR NOFIRNO® MULTI-CABLE TRANSIT SEALING SYSTEM

NOFIRNO® MULTI-FILLER SLEEVES



NOFIRNO® filler sleeve 10/4 multi 12

- art. no. 50.0301 for 60 mm length
- art. no. 50.0361 for 80 mm length
- art. no. 50.0311 for 110 mm length
- art. no. 50.0351 for 130 mm length
- art. no. 50.0321 for 140 mm length
- art. no. 50.0331 for 160 mm length
- art. no. 50.0341 for 210 mm length

to be used for smaller conduit openings

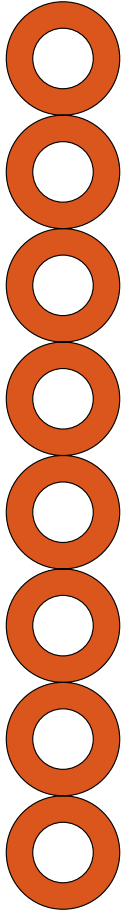

NOFIRNO® filler sleeve 15/8 multi 8

- art. no. 50.0302 for 60 mm length
- art. no. 50.0302 for 80 mm length
- art. no. 50.0362 for 110 mm length
- art. no. 50.0352 for 130 mm length
- art. no. 50.0322 for 140 mm length
- art. no. 50.0332 for 160 mm length
- art. no. 50.0342 for 210 mm length

NOFIRNO® filler sleeve 20/12 multi 6

- art. no. 50.0303 for 60 mm length
- art. no. 50.0363 for 80 mm length
- art. no. 50.0313 for 110 mm length
- art. no. 50.0353 for 130 mm length
- art. no. 50.0323 for 140 mm length
- art. no. 50.0333 for 160 mm length
- art. no. 50.0343 for 210 mm length

filler sleeves are supplied non-split

Operating temperatures:
-50 °C up to +180 °C

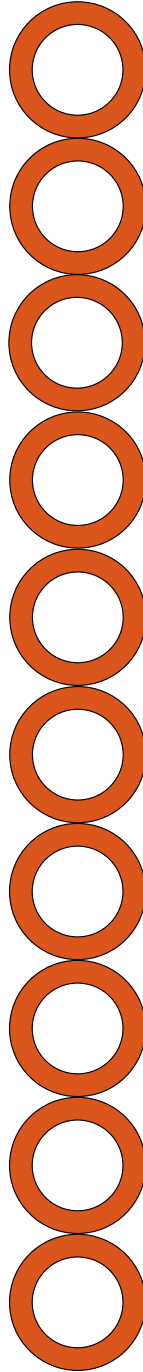

NOFIRNO® filler sleeve 18/12 multi 10

- art. no. 80.5050 for 60 mm length
- art. no. 80.5056 for 80 mm length
- art. no. 80.5051 for 110 mm length
- art. no. 80.5055 for 130 mm length
- art. no. 80.5052 for 140 mm length
- art. no. 80.5053 for 160 mm length
- art. no. 80.5054 for 210 mm length

to be used for larger conduit openings

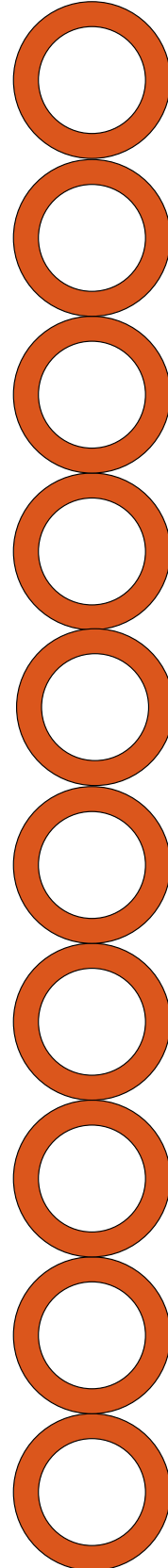

NOFIRNO® filler sleeve 22/15 multi 10

- art. no. 80.5070 for 60 mm length
- art. no. 80.5076 for 80 mm length
- art. no. 80.5071 for 110 mm length
- art. no. 80.5075 for 130 mm length
- art. no. 80.5072 for 140 mm length
- art. no. 80.5073 for 160 mm length
- art. no. 80.5074 for 210 mm length

to be used for larger conduit openings

INSTALLATION INSTRUCTIONS FOR NOFIRNO® MULTI-CABLE TRANSIT SEALING SYSTEM



The tools needed for the installation are a steel brush, a tie-wrap cutter, a cutter for the nozzles of the sealant cartridges, flat nose pliers to adjust the set of fillers, a filler set adjuster, cloths for cleaning and compression of the sealant layer, a cable cleaner, a bucket with water and a professional sealant dispenser.

INSTALLATION INSTRUCTIONS FOR NOFIRNO® MULTI-CABLE TRANSIT SEALING SYSTEM



The transit frames might be welded into the partition long before cable pulling will start. For this reason, the condition of the inside of the frame has to be checked when starting cable pulling. Before insertion of the NOFIRNO® cable and filler sleeves, the inside of the transit frames has to be cleaned, and any dirt, oil, grease and other residues or corrosion should be removed from the inside of the transit frame.

Note: for fire resistant penetrations the max. size of the transit frame is 600x300 mm or equivalent of 1800 cm².

INSTALLATION INSTRUCTIONS FOR NOFIRNO® MULTI-CABLE TRANSIT SEALING SYSTEM



With a steel brush or by blasting, the corroded inner surface of the transit frame should be treated to remove these corroded spots. The excellent adhesive properties of the sealing system will be diminished by corroded surfaces.

INSTALLATION INSTRUCTIONS FOR NOFIRNO® MULTI-CABLE TRANSIT SEALING SYSTEM

the 15 mm sealant layer is according to the newest certification. Due to the length of existing coamings maximum 20 mm is allowed

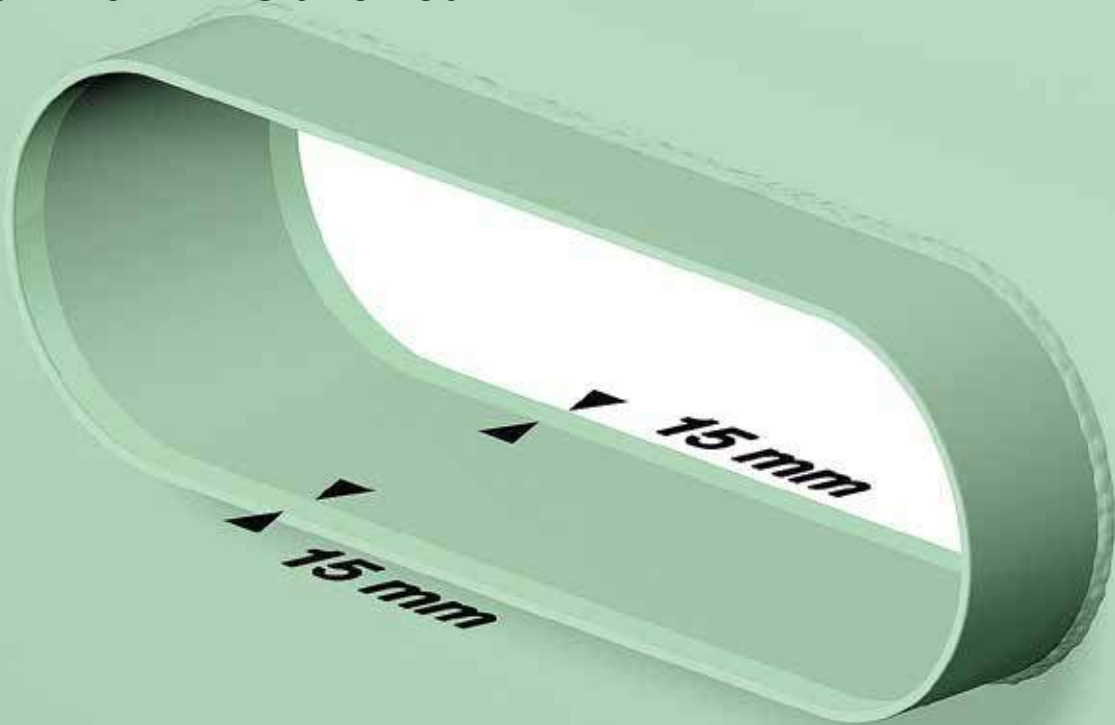

The NOFIRNO® sealing system is composed of cable and filler sleeves, and layers of sealant. The sleeves are the backing on which the sealant is going to be applied. A 15 (20) mm thick layer of sealant is applied at both sides of the penetration. Before welding the transit frame into the partition, check if the transit frame is deep enough to be in line with the certification of the sealing system (minimum 160 mm). The NOFIRNO® sleeves are 30 mm shorter in length than the depth of the transit frame. Note: for high rated watertight penetrations, the transit frame should be either of a limited size or partitions should be placed inside the larger transit frames to divide the frame in smaller sections.

INSTALLATION INSTRUCTIONS FOR NOFIRNO® MULTI-CABLE TRANSIT SEALING SYSTEM

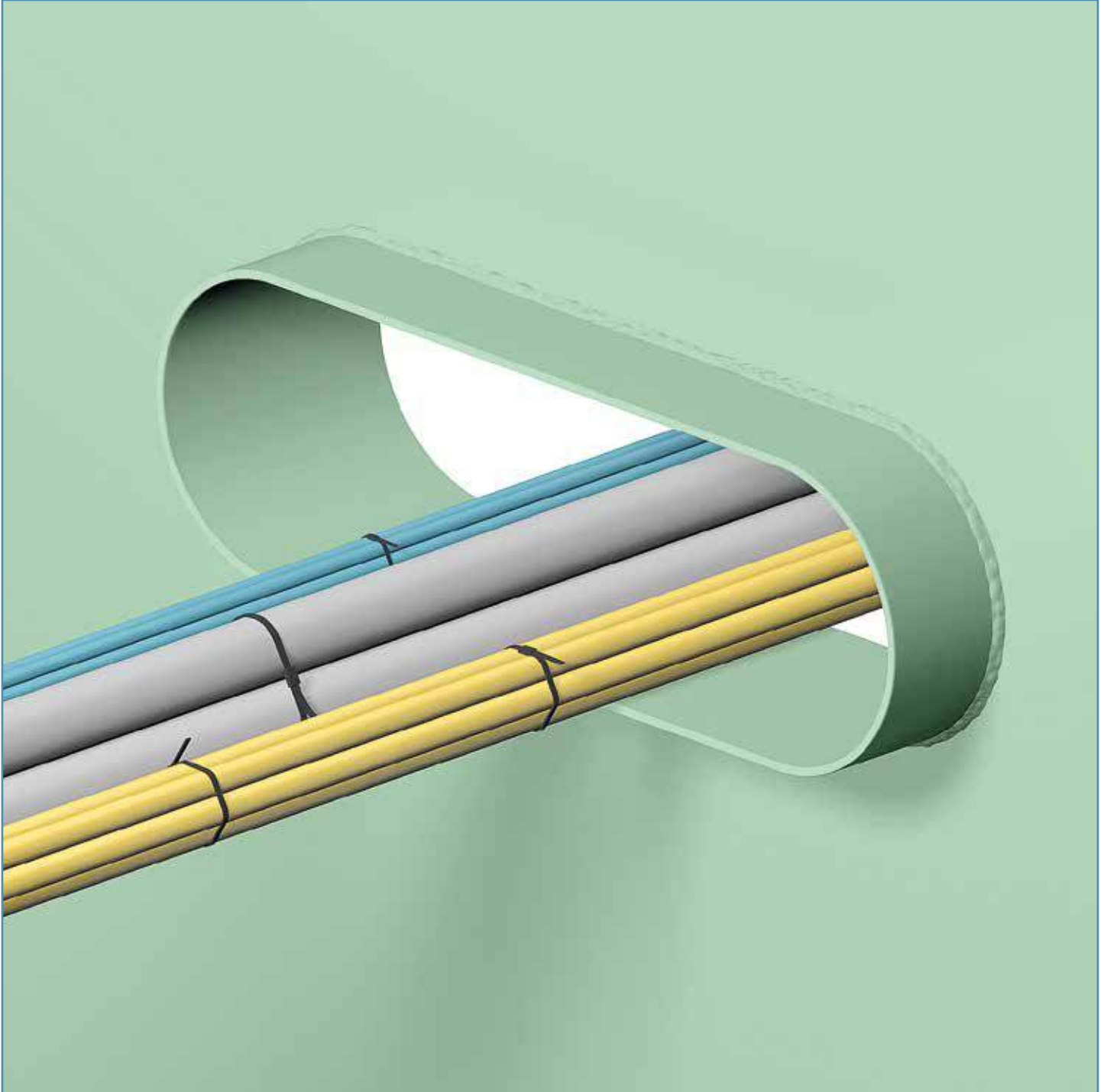

The cables can be ducted through the transit frame in random order. It is most important that they are not pulled too tight so as not to hamper their separation when NOFIRNO® insert sleeves are inserted. Open transits at site allow for pulling more cables through than planned. Sealing the multi-cable penetration will then be difficult or not possible at all. Tangled cable sets can make the installation of the sealing system extremely difficult. Ease of installation starts with organized pulling of the cables through the transit frames.

INSTALLATION INSTRUCTIONS FOR NOFIRNO® MULTI-CABLE TRANSIT SEALING SYSTEM

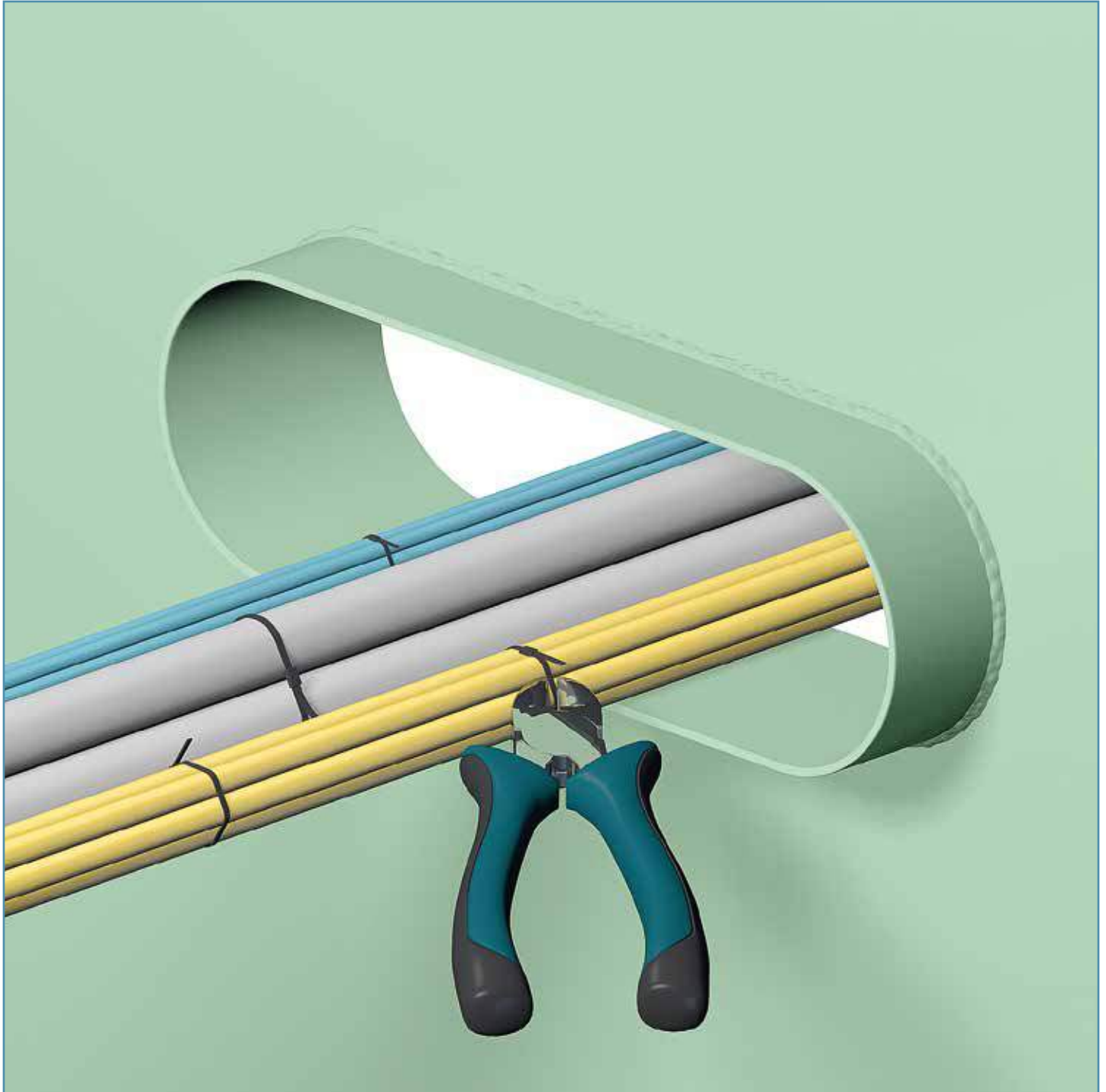

The cable tie-wraps have to be removed to create enough play in between the cables to enable cleaning of the cables and to allow insertion of the NOFIRNO® cable sleeves in a later stage.

INSTALLATION INSTRUCTIONS FOR NOFIRNO® MULTI-CABLE TRANSIT SEALING SYSTEM

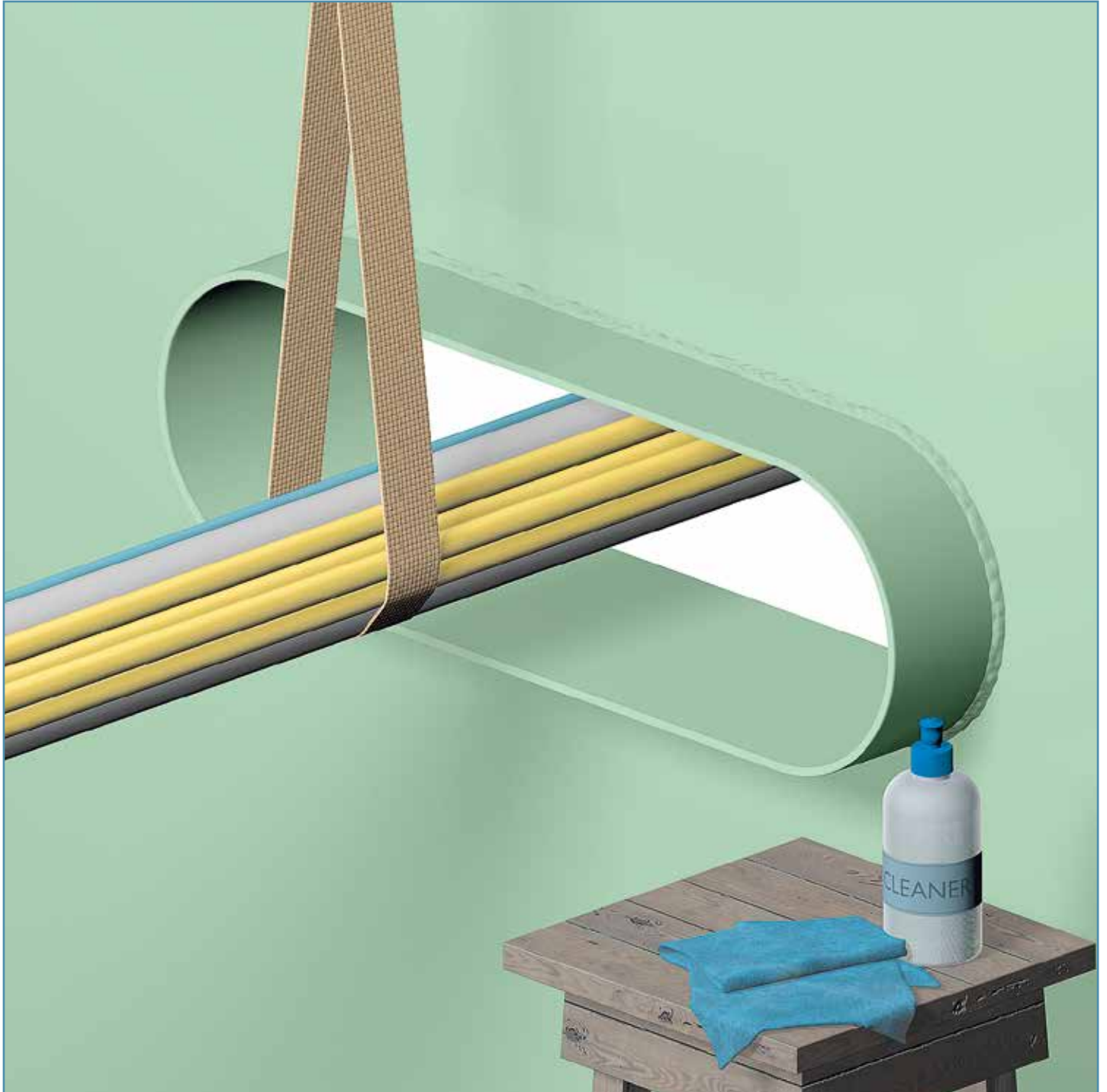

For adequate cleaning purposes (which is an important step), the cables could be lifted with a band to create sufficient access to the inner wall of the transit frame.

INSTALLATION INSTRUCTIONS FOR NOFIRNO® MULTI-CABLE TRANSIT SEALING SYSTEM



Final sealing of the cable penetration may be quite some time after cable pulling. In such a situation, the status of the inside of the transits frames has to be checked again when starting with the installation of the sealing system. Clean the inside of the transit frames thoroughly and remove any dirt, oil, grease and other residues or corrosion from the inside of the transit frame.

INSTALLATION INSTRUCTIONS FOR NOFIRNO® MULTI-CABLE TRANSIT SEALING SYSTEM



Clean and dry the cables thoroughly in a similar way. Any moisture, dirt or oil residues will have a negative impact on the adhesive properties of the NOFIRNO® sealant to be applied after filling the transit frame.

INSTALLATION INSTRUCTIONS FOR NOFIRNO® MULTI-CABLE TRANSIT SEALING SYSTEM

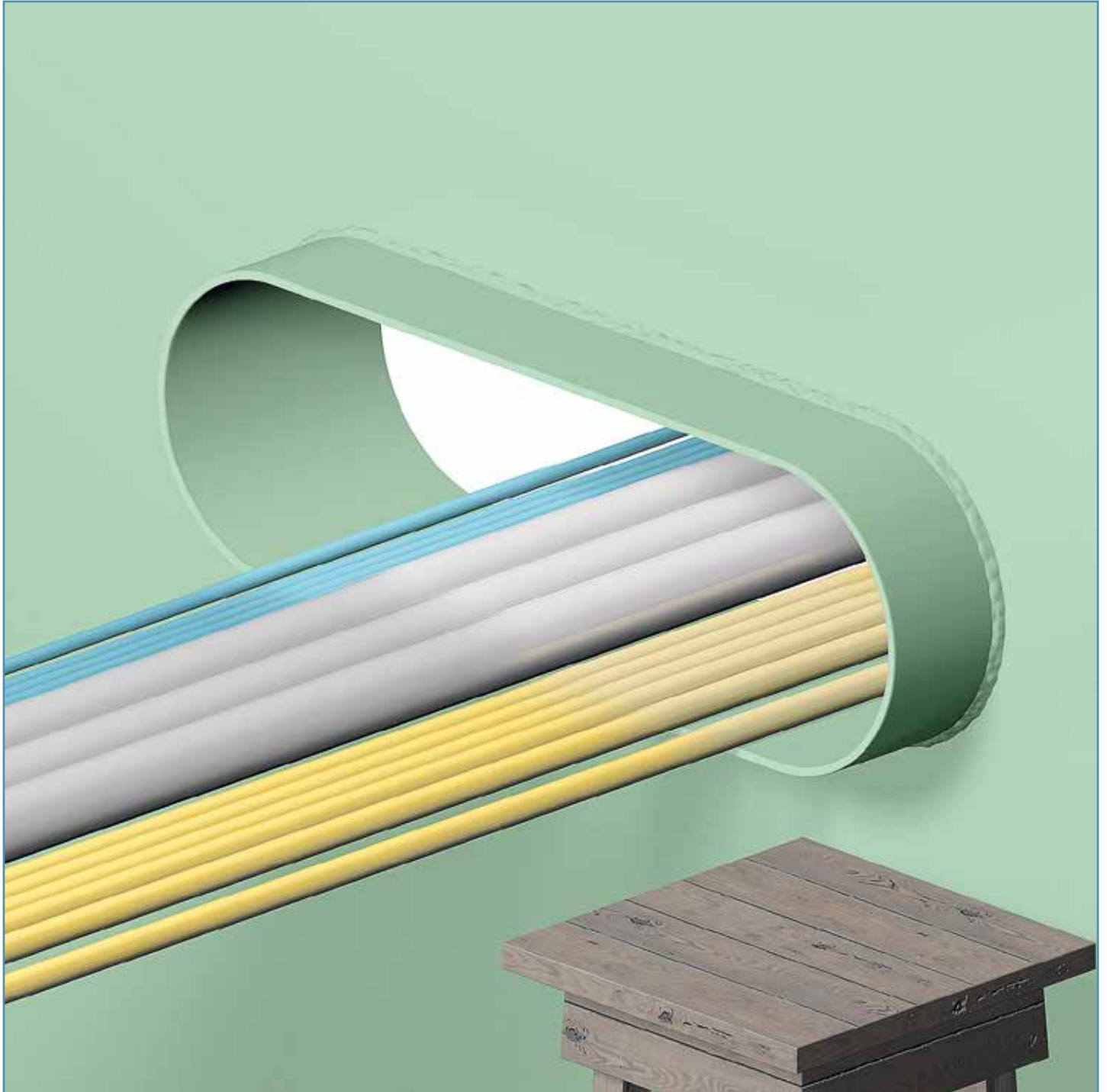

The cables have to be cleaned at the spot where the sealant is applied in a later stage. This means 15 mm at both sides of the transit. If feasible, it is of course easier to clean the cables over their full length inside the transit.

INSTALLATION INSTRUCTIONS FOR NOFIRNO® MULTI-CABLE TRANSIT SEALING SYSTEM

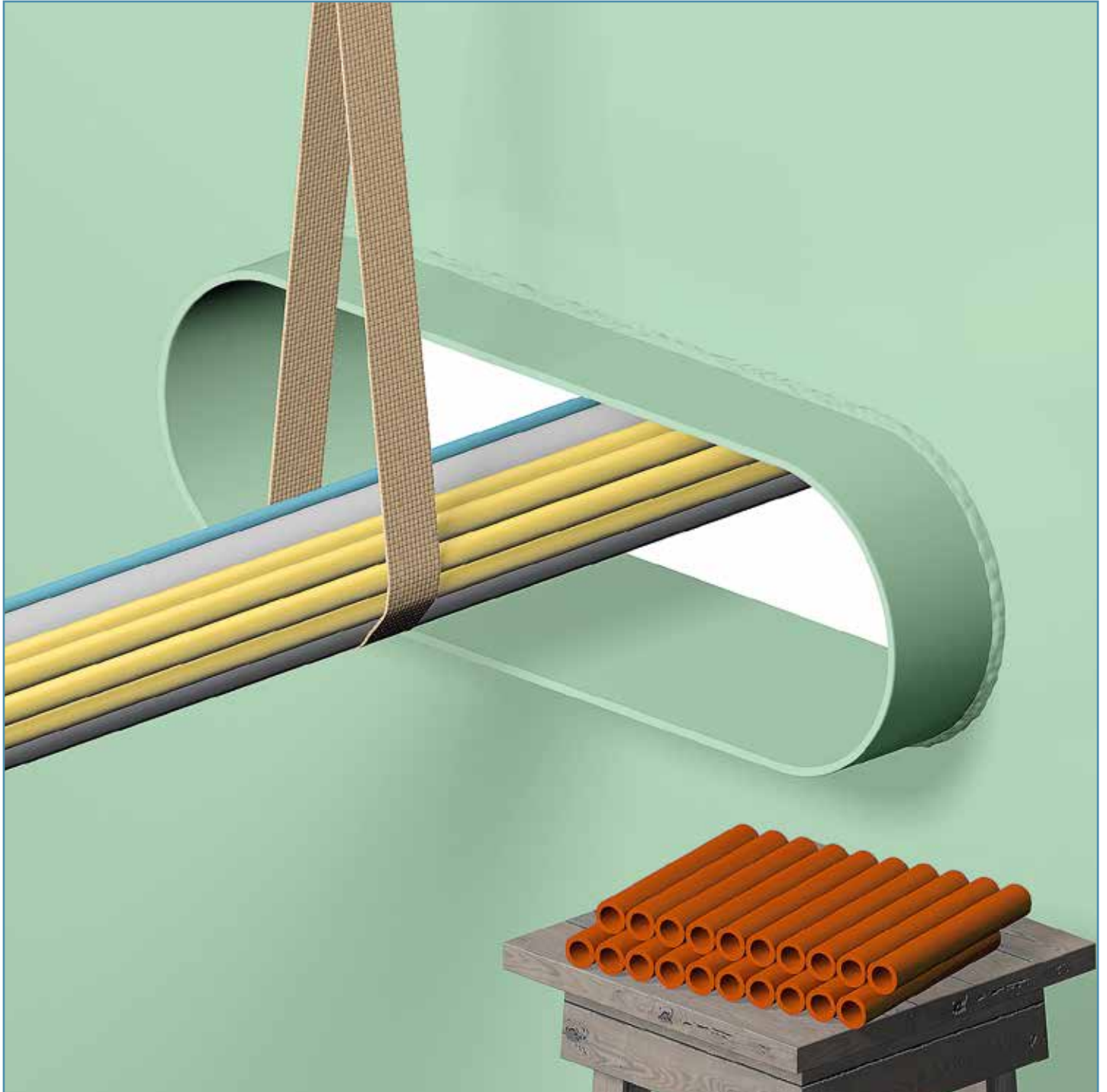

Although the system is tested with the cables separated from the wall of the transit frame by the thickness of the NOFIRNO® cable sleeves, it is advisable to have a layer of NOFIRNO® multi-sleeves at the bottom of the transit frame prior to spread out the cables.

INSTALLATION INSTRUCTIONS FOR NOFIRNO® MULTI-CABLE TRANSIT SEALING SYSTEM

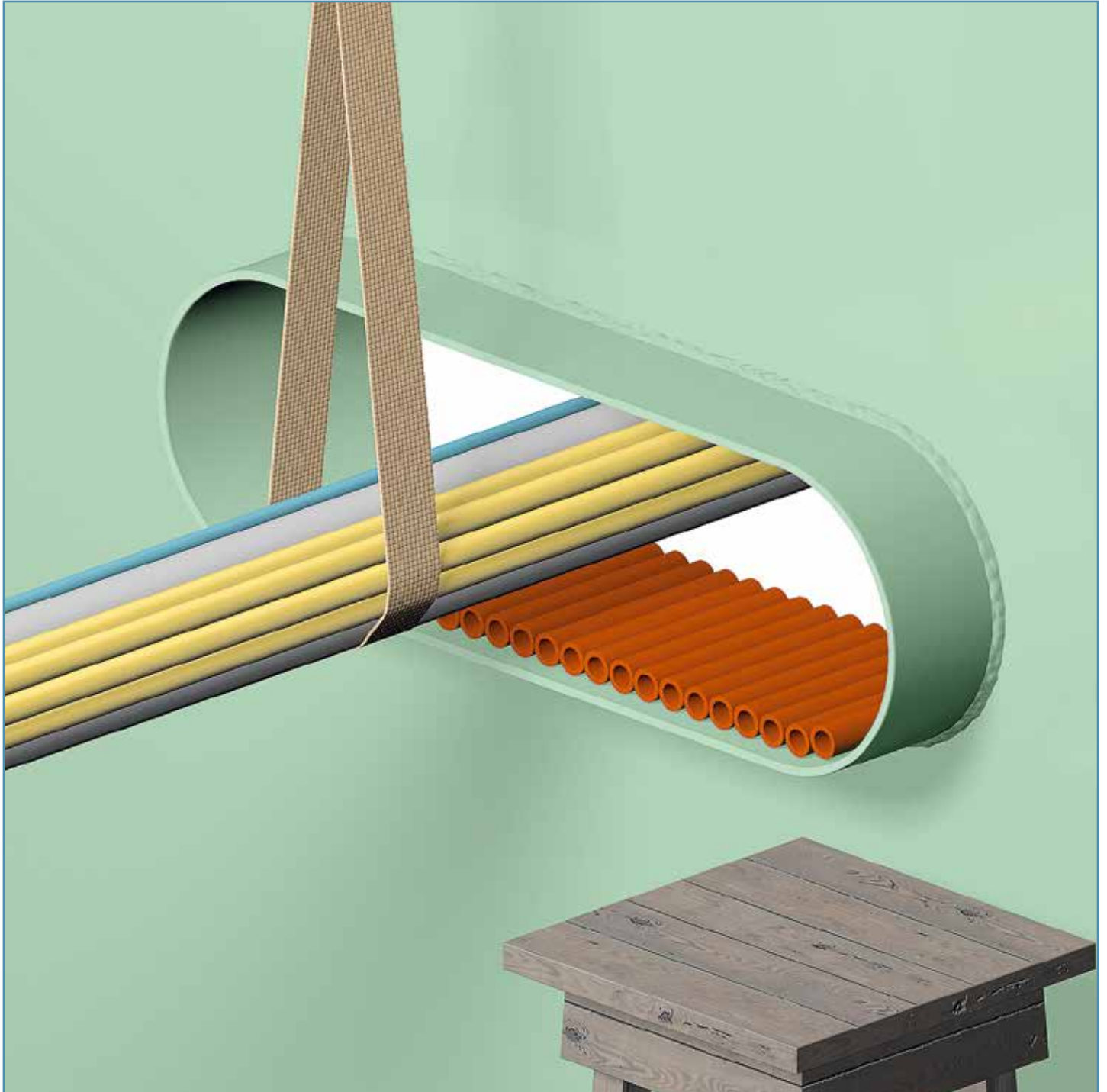

By lifting the cables the set(s) of NOFIRNO® multi-filler sleeves can be easily placed inside the transit frame.

INSTALLATION INSTRUCTIONS FOR NOFIRNO® MULTI-CABLE TRANSIT SEALING SYSTEM

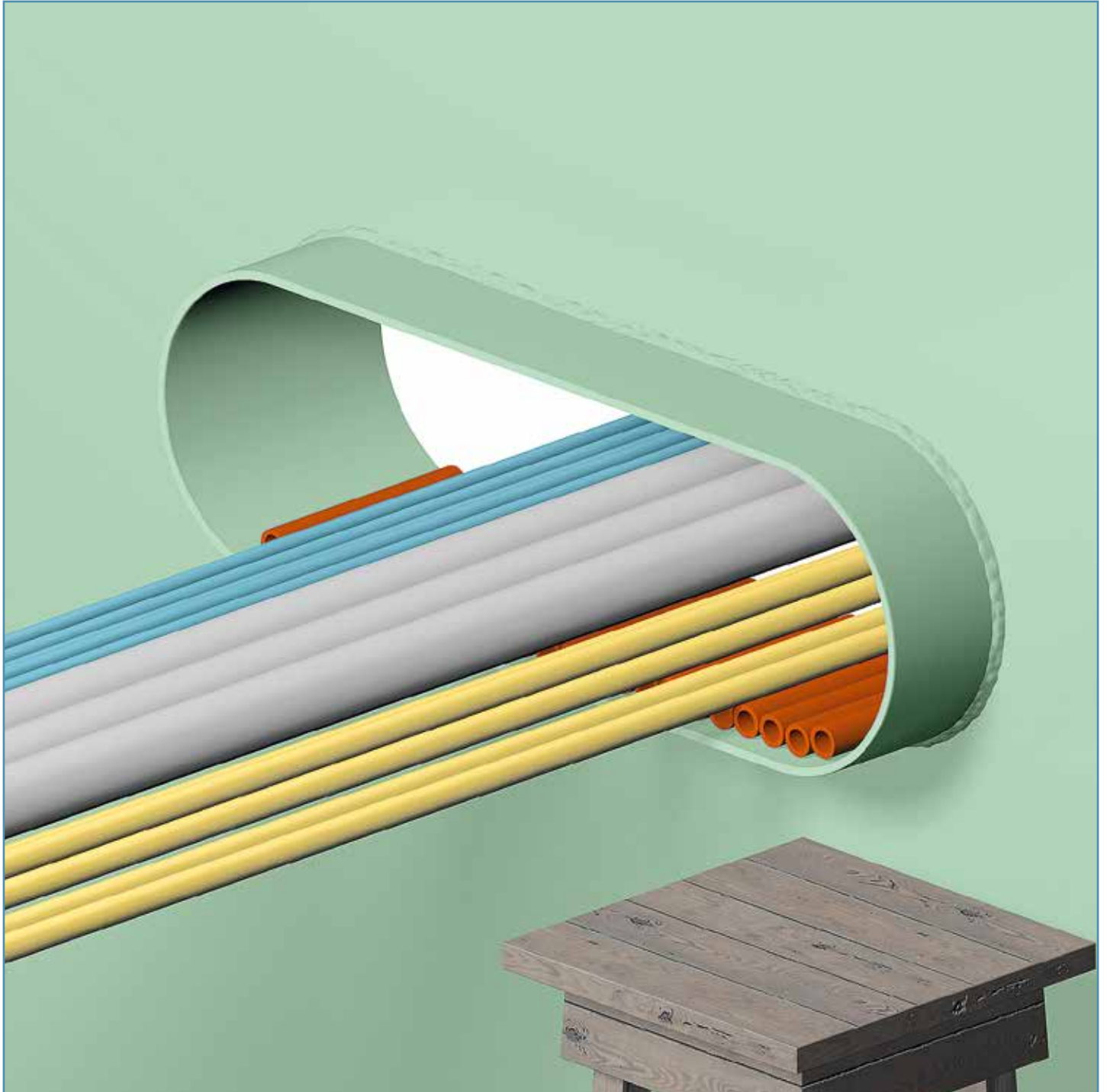

The cables are then separated as far as possible on top of the NOFIRNO® multi-filler sleeves. The application of the NOFIRNO® multi-filler sleeves underneath the cables makes the application of the sealant for final finishing at the bottom of the transit not only easier but also more effective. NOFIRNO® multi-filler sleeves also prevent the cables from touching the steel frame, which can lead to shaving and damaging the cables.

INSTALLATION INSTRUCTIONS FOR NOFIRNO® MULTI-CABLE TRANSIT SEALING SYSTEM



NOFIRNO® cable insert sleeves are separators and not precise filling parts. Applying oversized sleeves around the cables will reduce the filling capacity of the sealing system. Due to the fact that the NOFIRNO® rubber is very endothermic and is fully protected by the NOFIRNO® sealant, this will not, however, have an influence on the fire rating as long the sleeves are not extremely oversized.

INSTALLATION INSTRUCTIONS FOR NOFIRNO® MULTI-CABLE TRANSIT SEALING SYSTEM

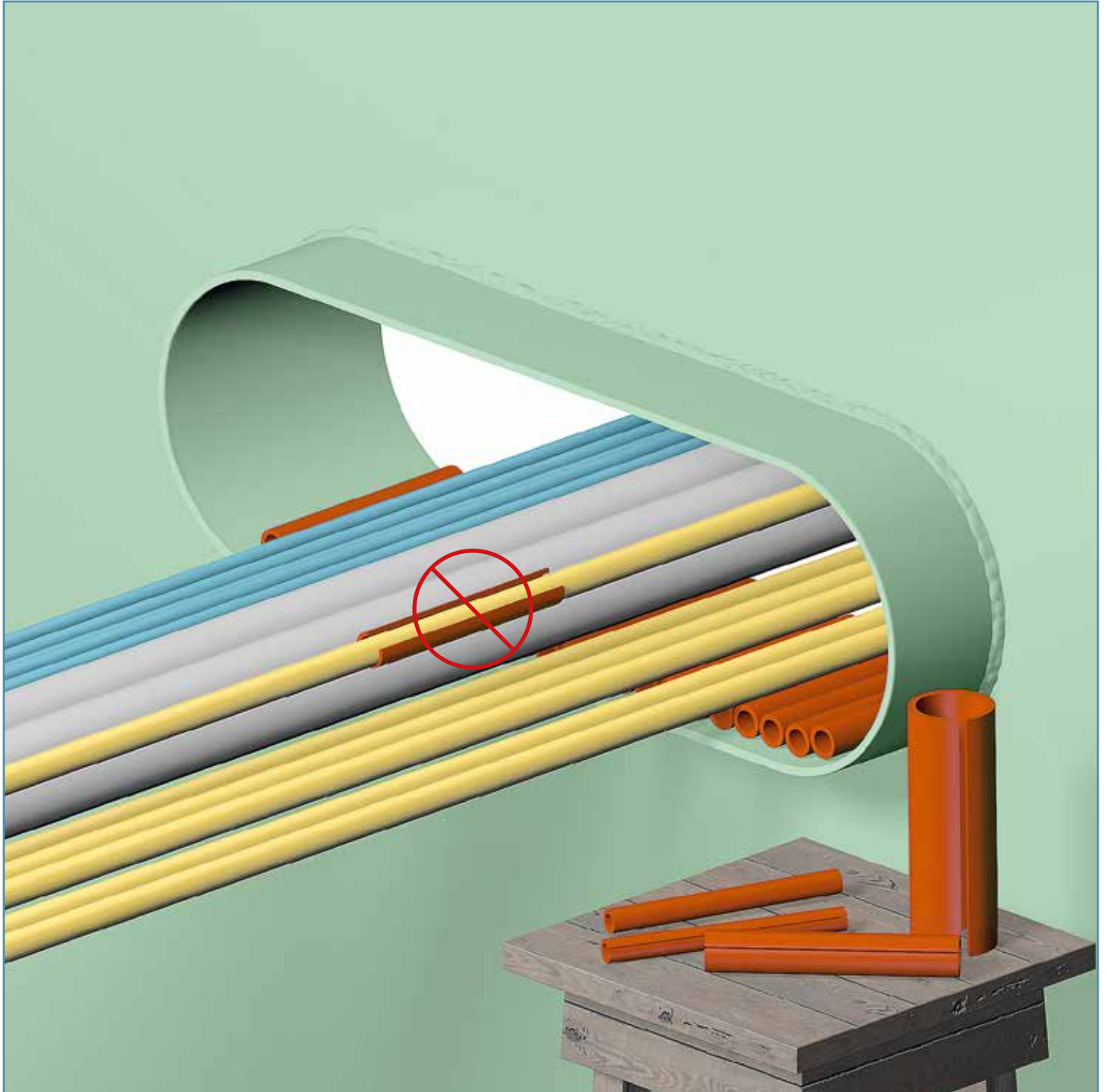

A precise fit of the NOFIRNO® cable sleeves around the cables is not required, however it is not allowed to use undersized cable sleeves leaving a larger open space around the cable. See the tables on page 6.

INSTALLATION INSTRUCTIONS FOR NOFIRNO® MULTI-CABLE TRANSIT SEALING SYSTEM



NOFIRNO® cable sleeves are applied around each cable. The cable sleeves are split lengthwise and can therefore be placed around the cables in front of the conduit.

INSTALLATION INSTRUCTIONS FOR NOFIRNO® MULTI-CABLE TRANSIT SEALING SYSTEM

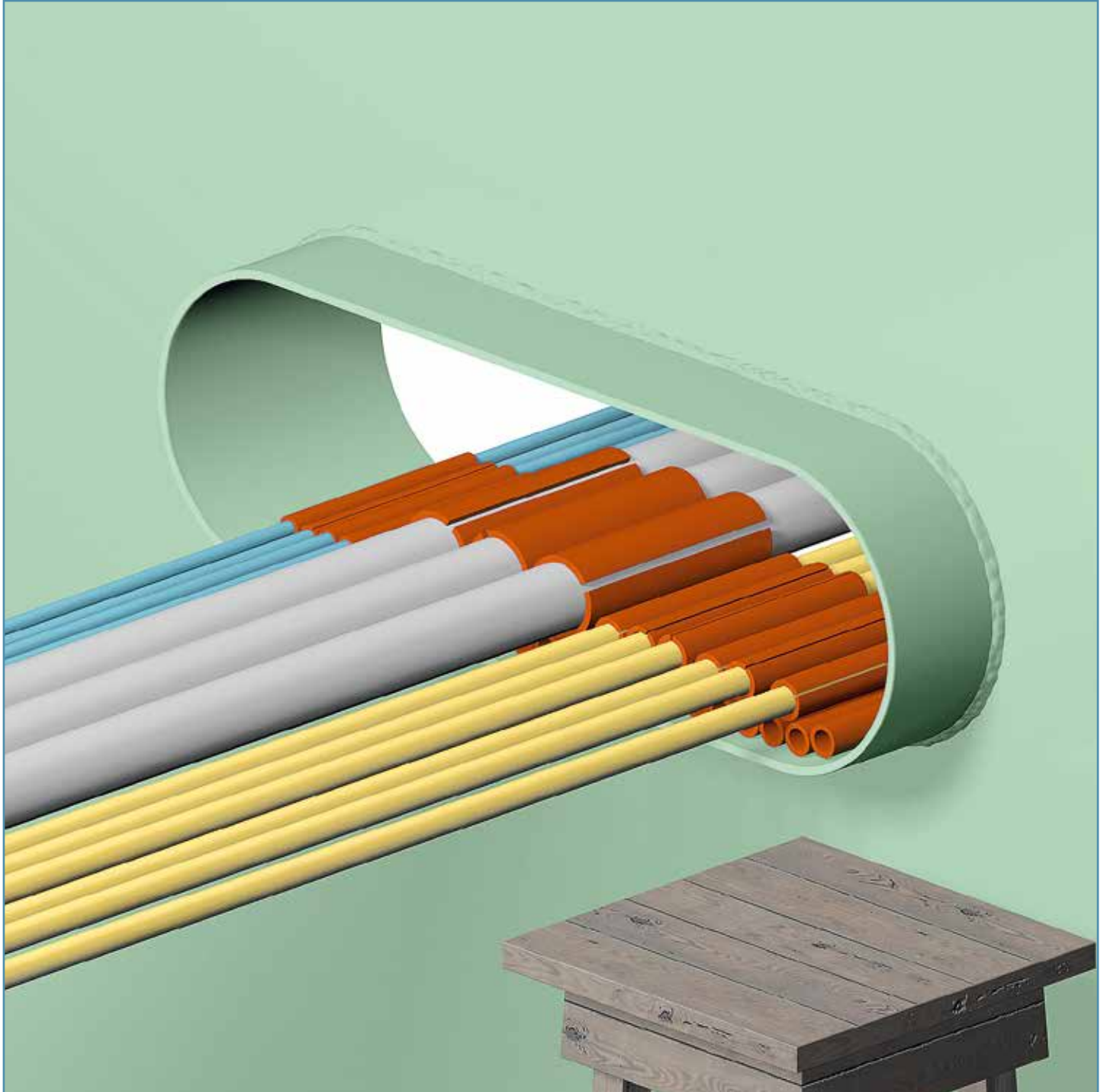

Push the insert sleeves into the transit frame in such a way as to leave about 15 (20) mm free space at the front and the back. At this stage, and certainly with a low filling rate of cables, the insertion does not have to be precise in this regard. Adjustment of the set of sleeves to the 15 (20) mm recess can be carried out just before applying the sealant. However, with higher filling rates it might be difficult to correct afterwards.

INSTALLATION INSTRUCTIONS FOR NOFIRNO® MULTI-CABLE TRANSIT SEALING SYSTEM

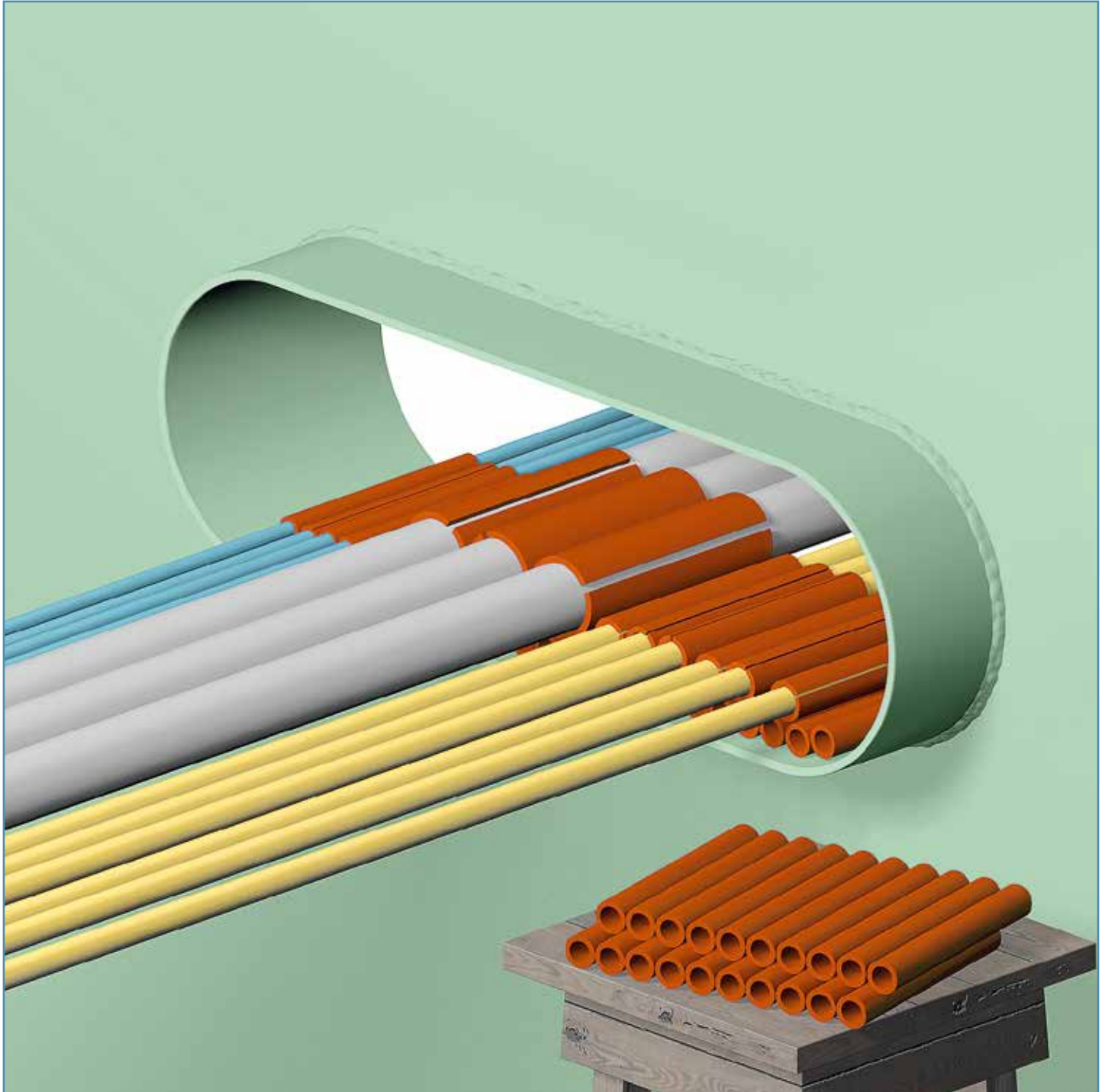

The remaining free space in the conduit opening is filled with NOFIRNO® filler sleeves type 18/12, 20/12 or 22/15 or a combination of these types. The smaller sleeves sizes 10/4 and 15/8 are used to fill smaller open spaces present in the complete set of filler sleeves. For ease of filling, the NOFIRNO® filler sleeves are supplied non-split. They are delivered also as multi-filler sleeves (multi-sets of 6, 8, 10 and 12 sleeves) which is extremely helpful for filling larger empty spaces.

INSTALLATION INSTRUCTIONS FOR NOFIRNO® MULTI-CABLE TRANSIT SEALING SYSTEM

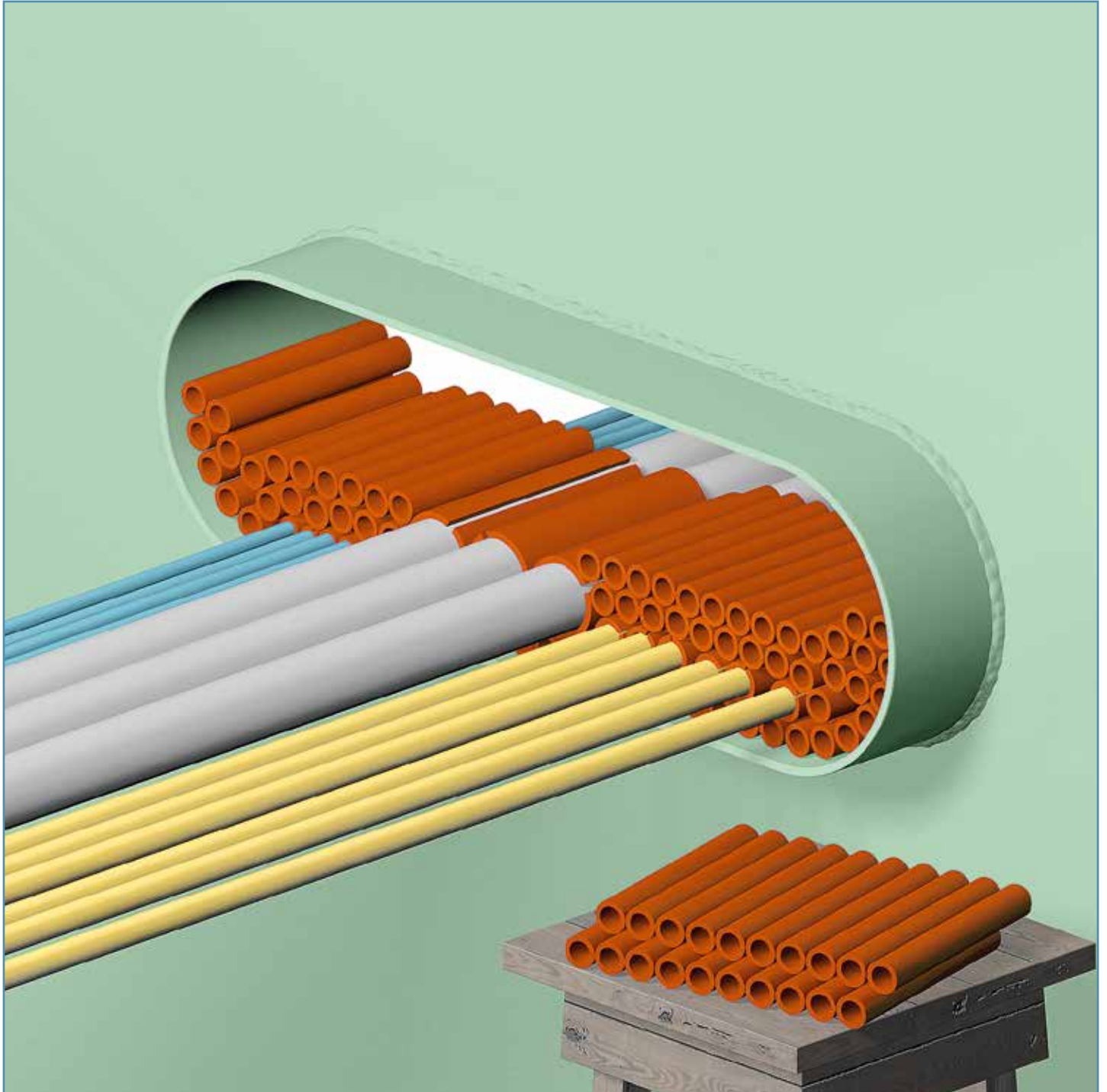

For later extensions, it is advisable to use NOFIRNO® single filler sleeves, since they are easier to remove when a new cable has to be ducted.

INSTALLATION INSTRUCTIONS FOR NOFIRNO® MULTI-CABLE TRANSIT SEALING SYSTEM

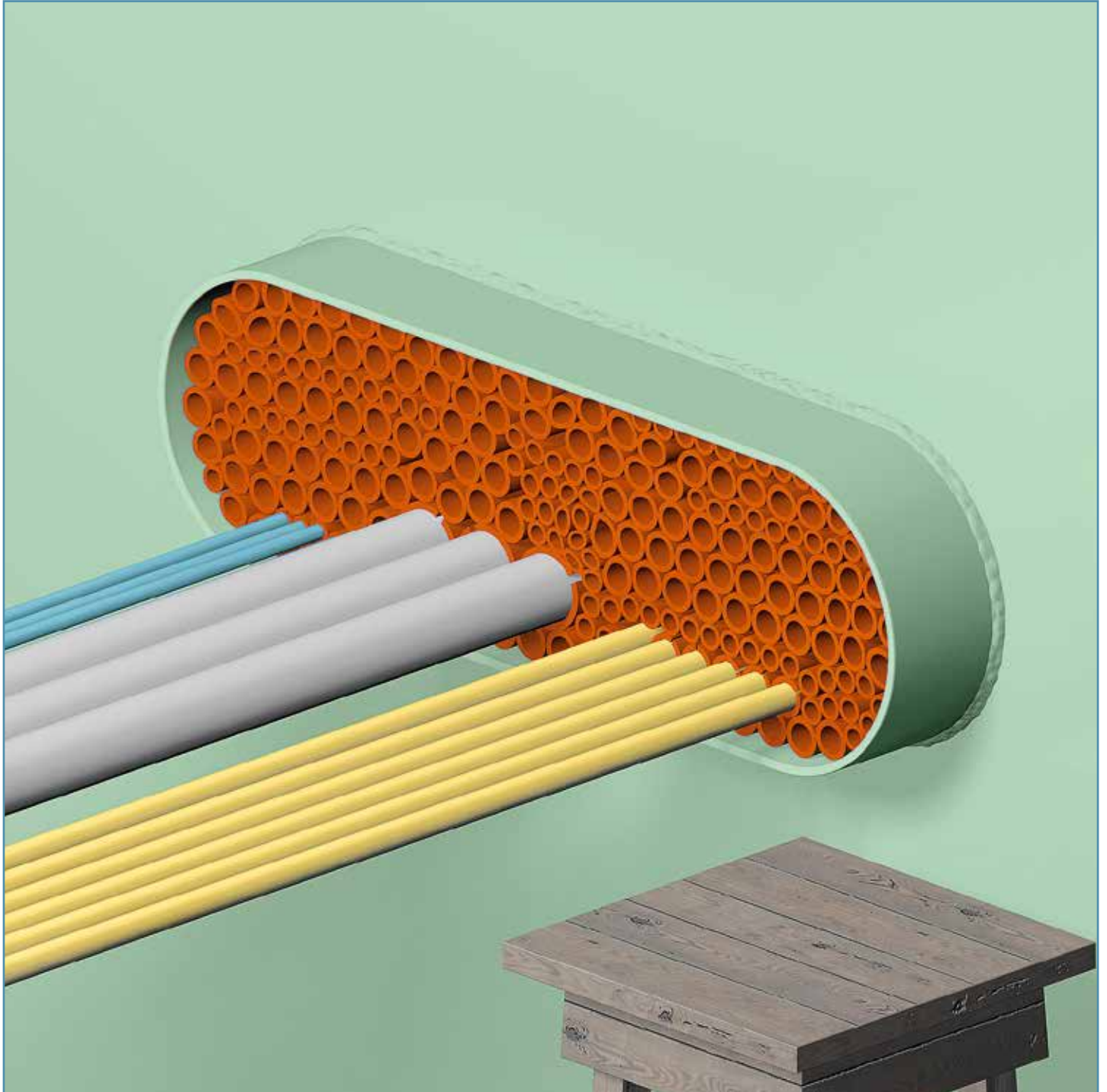

It is allowed to use one type of NOFIRNO® filler sleeves only or a mix of all types of NOFIRNO® filler sleeves.

INSTALLATION INSTRUCTIONS FOR NOFIRNO® MULTI-CABLE TRANSIT SEALING SYSTEM

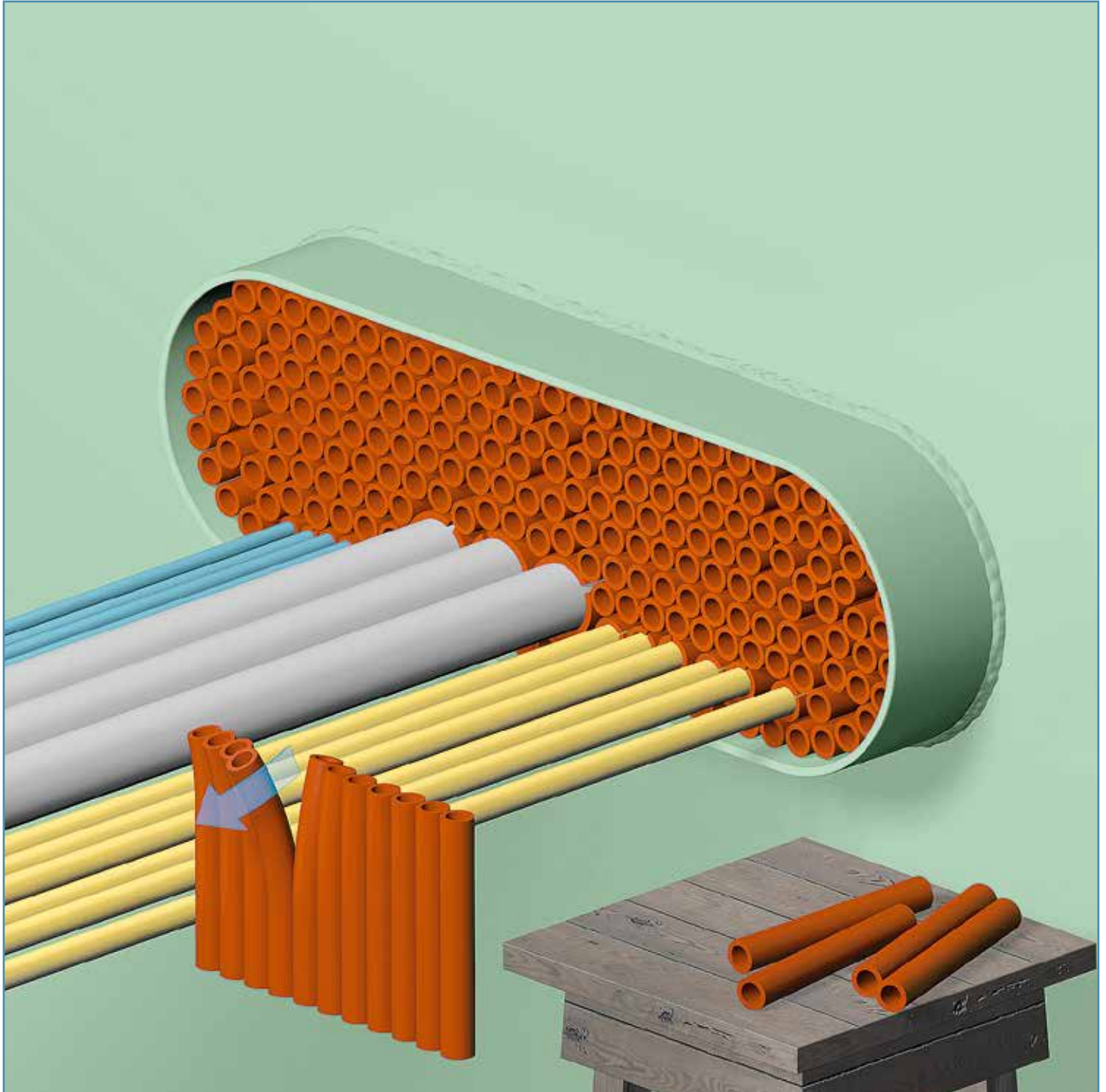

The smaller openings are now filled with parts of the sets of multi-filler sleeves. To tear off sleeves from the multi-set, the procedure is to do this backwards/forwards and not sideways. This is because of the strength of the intermediate rubber parts.

INSTALLATION INSTRUCTIONS FOR NOFIRNO® MULTI-CABLE TRANSIT SEALING SYSTEM

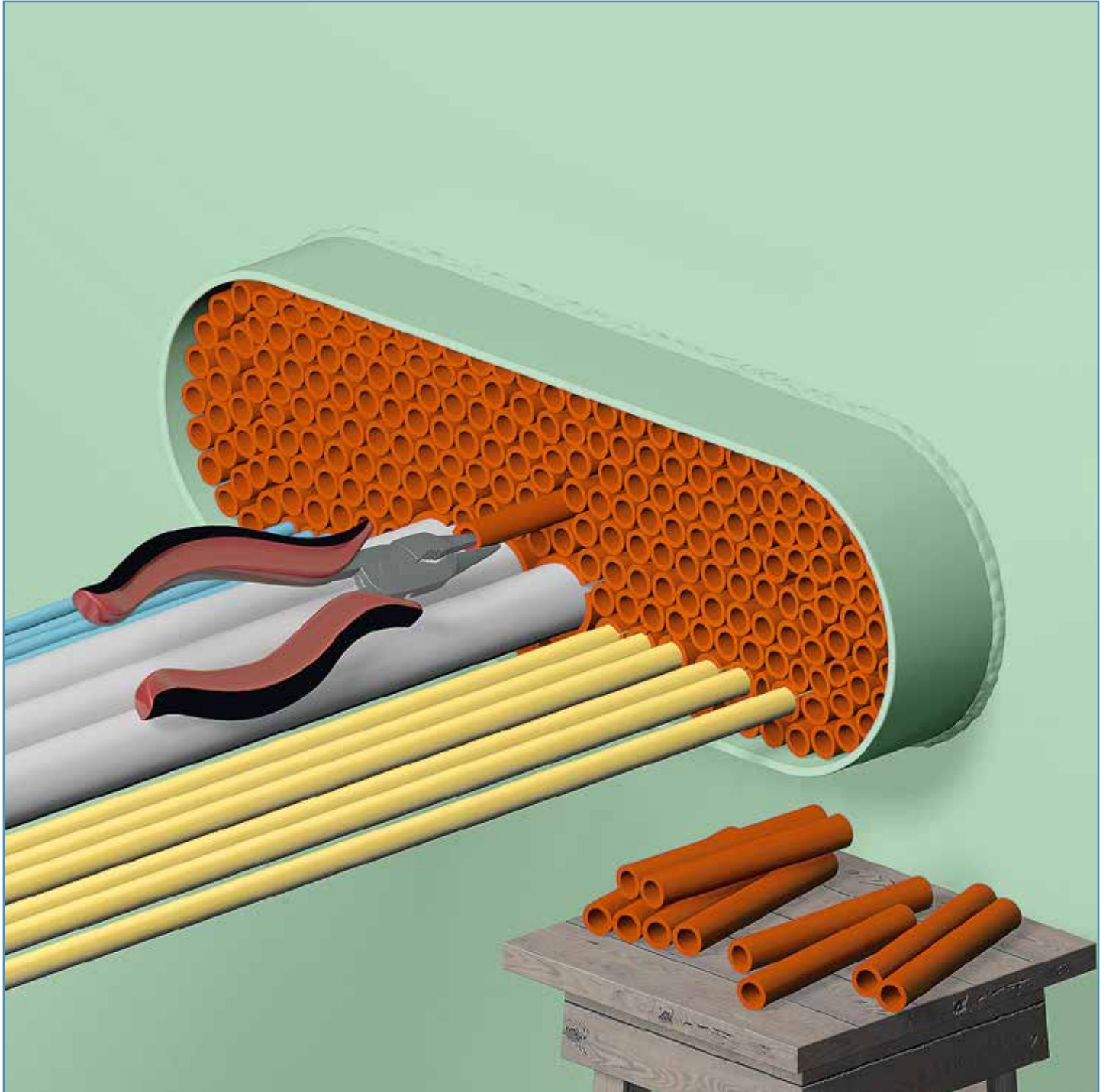

With a flat nose pliers, NOFIRNO® single filler sleeves are inserted in the remaining smaller open spaces in the set of fillers. A very tight fit of the filling is vital to the performance of the sealing system.

INSTALLATION INSTRUCTIONS FOR NOFIRNO® MULTI-CABLE TRANSIT SEALING SYSTEM

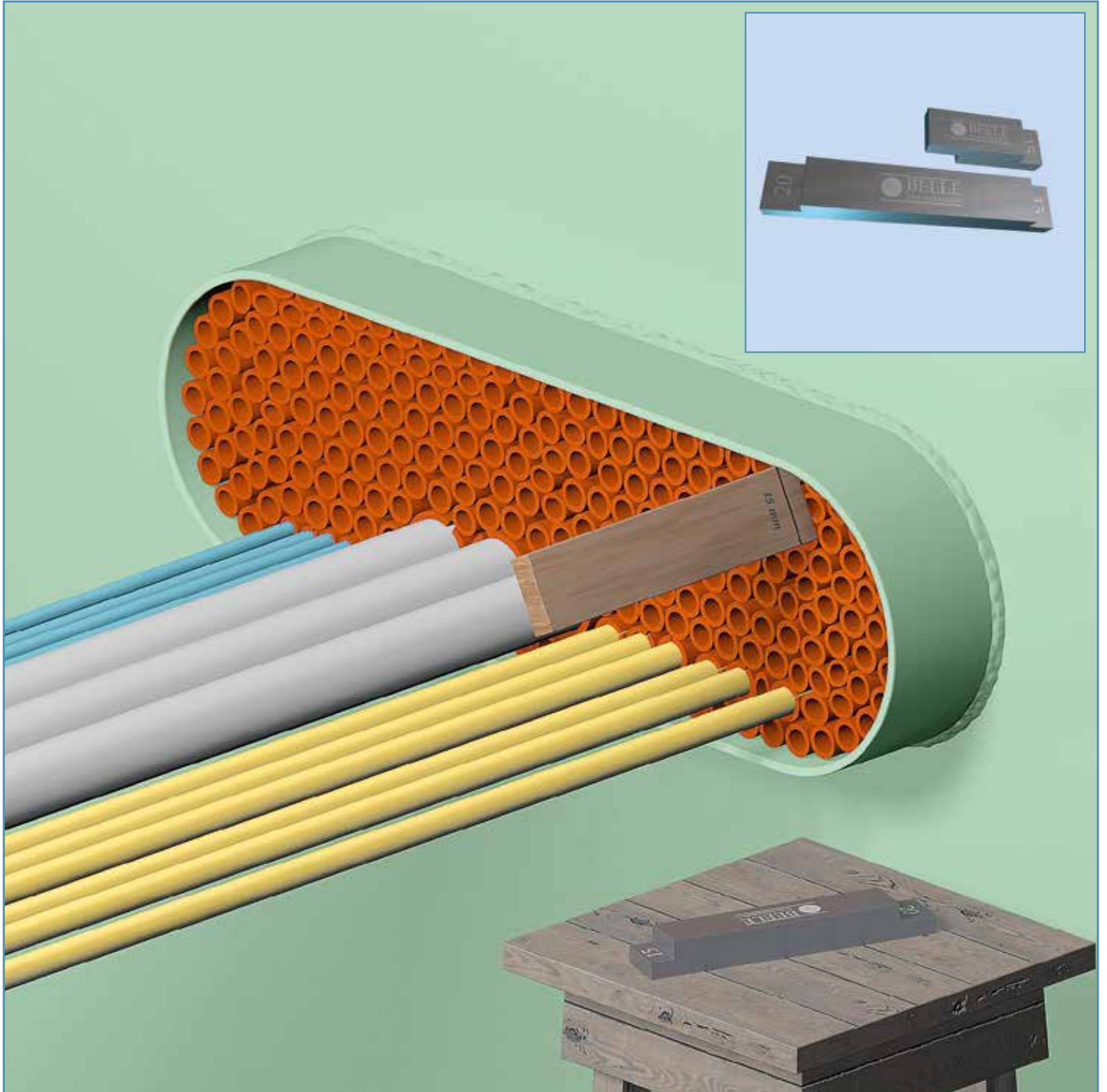

With a piece of wood marked with the required 15 mm depth, or with the by BEELE Engineering developed aluminum adjuster, the set of fillers can be adjusted to the required 15 (20) mm recess inside the transit. Use a plastic hammer to adjust the set of filler sleeves with the NOFIRNO® adjuster.

INSTALLATION INSTRUCTIONS FOR NOFIRNO® MULTI-CABLE TRANSIT SEALING SYSTEM

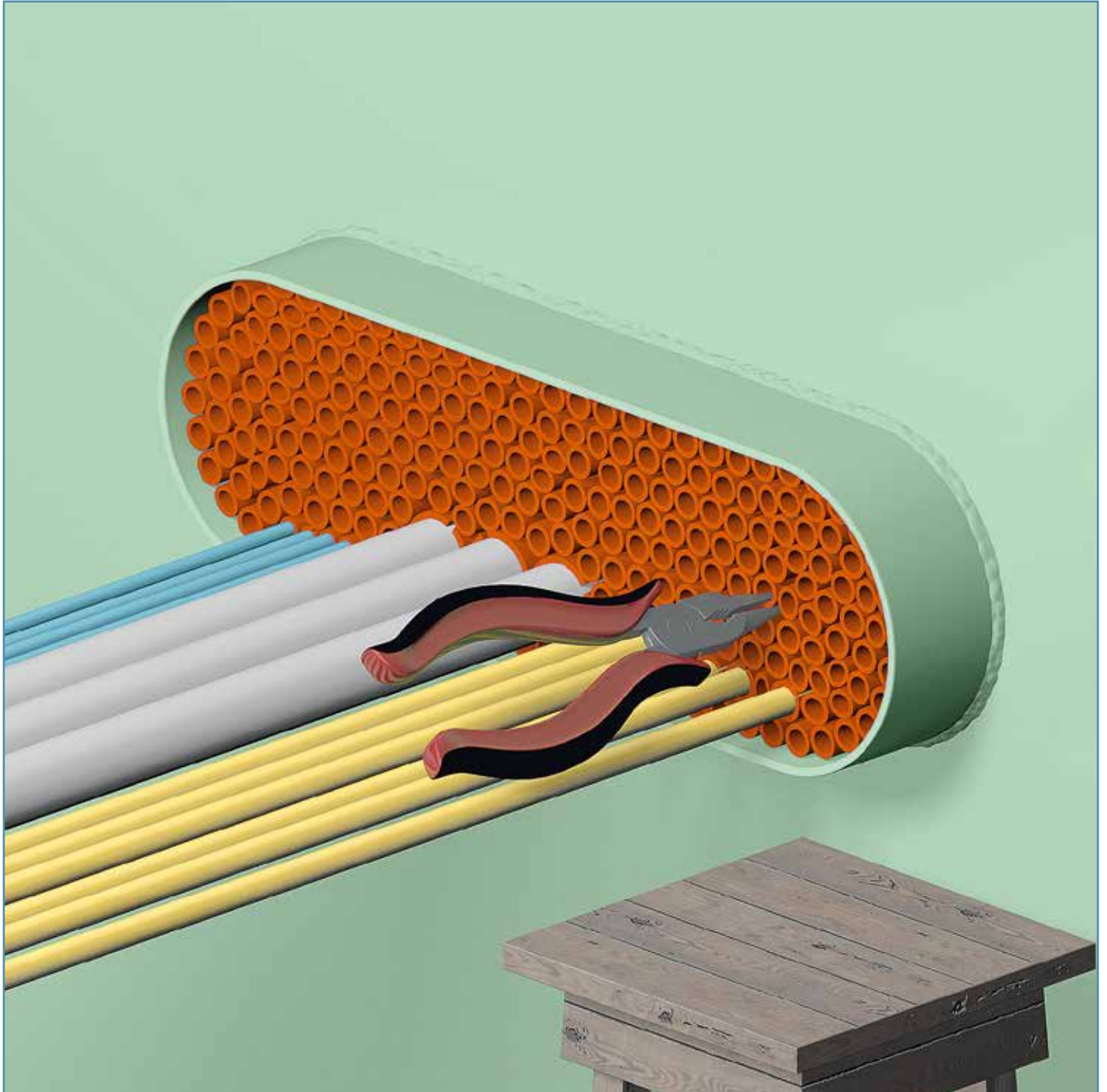

The filler set can be further adjusted with the aid of a flat nose pliers. Single filler sleeves sometimes might be inserted too deep. A ca. 15 (20) mm free space at the front and back of the sealing system (+/- 1 mm (15) and +/- 2 mm (20) tolerance is acceptable) is a must to obtain optimum sealing capacity of the sealing system.

INSTALLATION INSTRUCTIONS FOR NOFIRNO® MULTI-CABLE TRANSIT SEALING SYSTEM

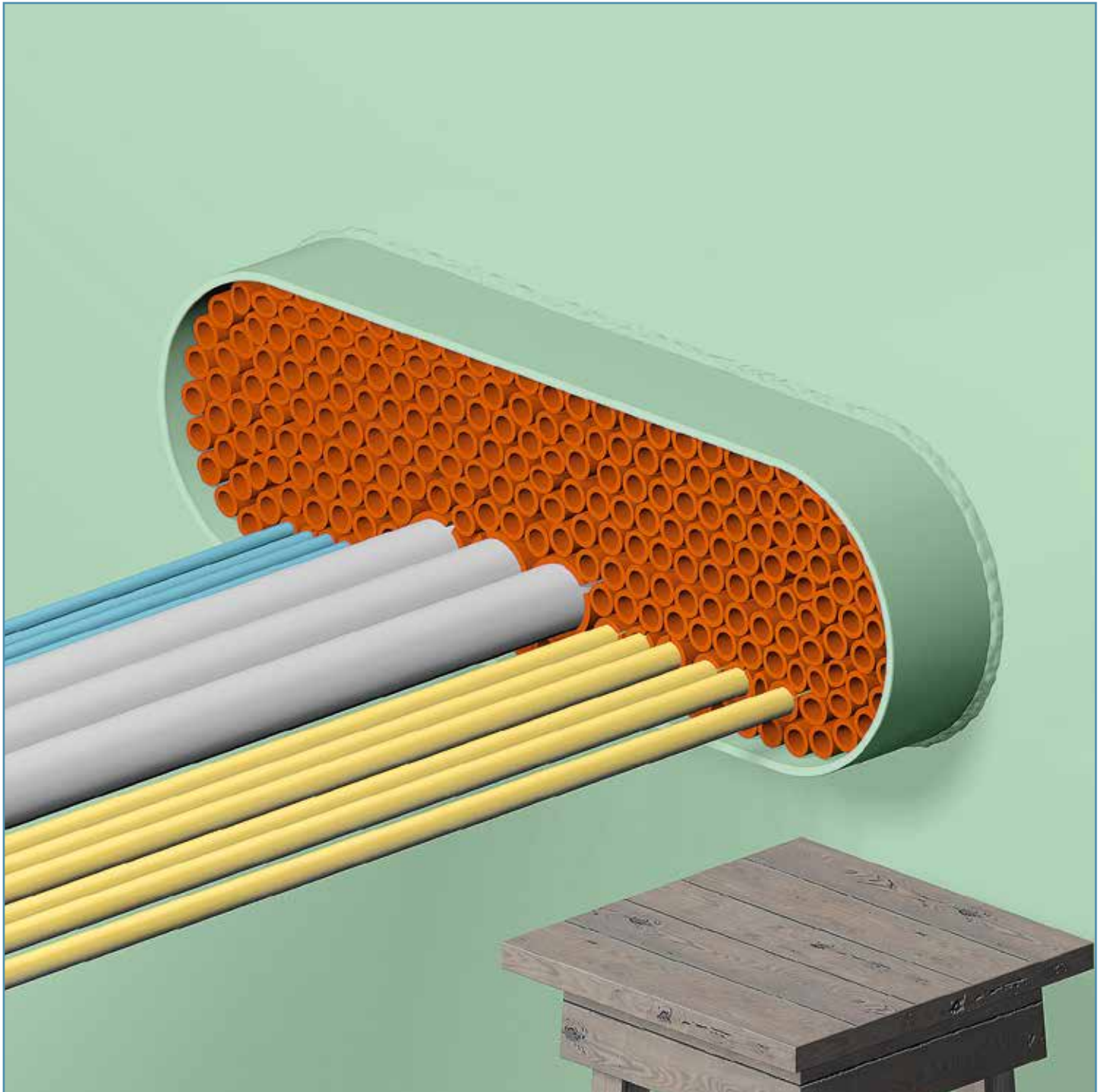

Before applying the NOFIRNO® sealant, it is advisable to perform a final check on the packing of insert and filler sleeves. A tight fit of the whole set of sleeves, in the required ratio, is not only vital for the mechanical stability of the sealing system, but also for the fire stopping properties. A final check should therefore be a part of quality control.

INSTALLATION INSTRUCTIONS FOR NOFIRNO® MULTI-CABLE TRANSIT SEALING SYSTEM

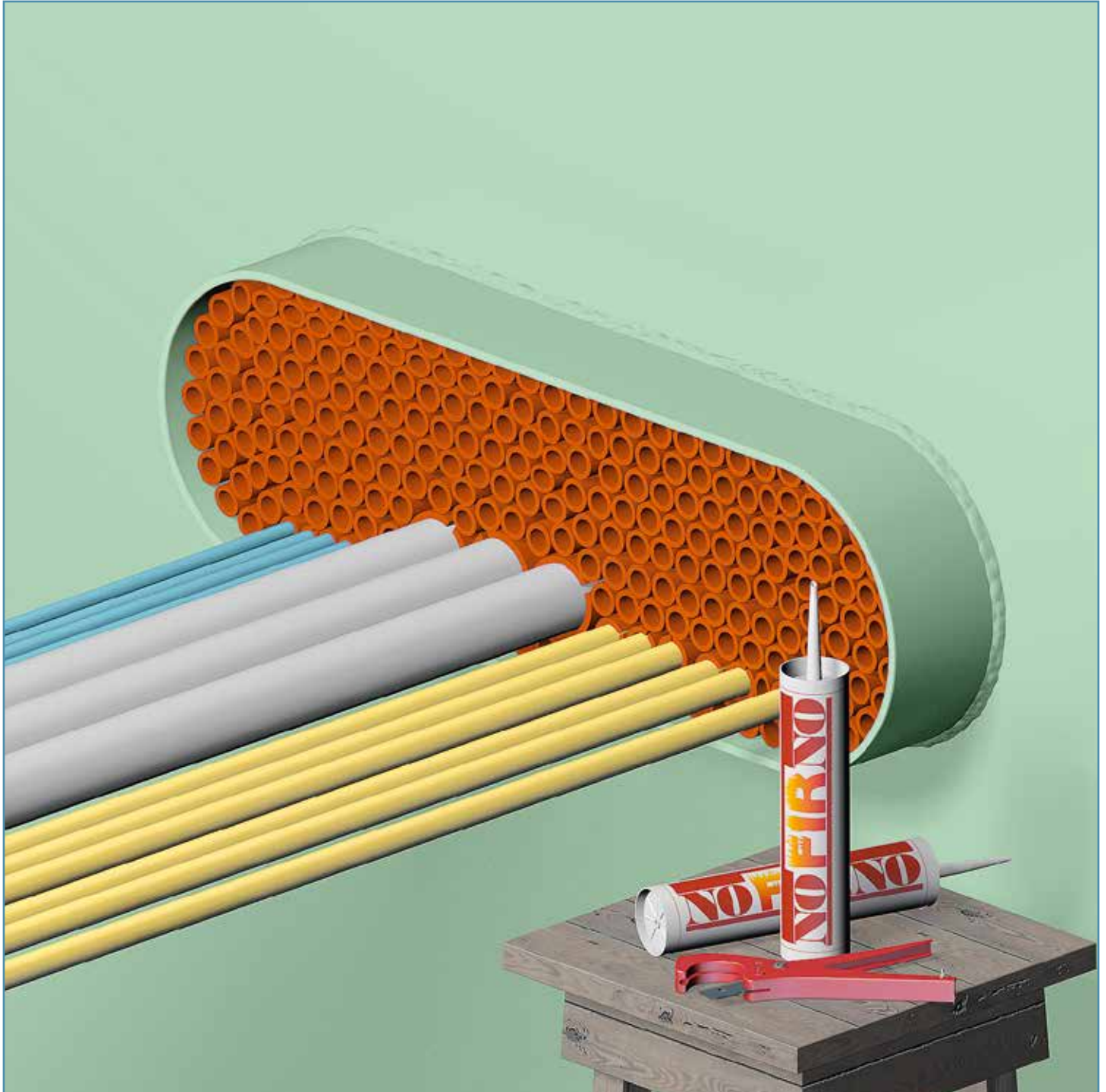

Final smoke, gas and watertight sealing of the NOFIRNO® multi-cable transits is achieved with the application of NOFIRNO® sealant. NOFIRNO® sealant has proven excellent performance with regard to mechanical and fire resistance requirements. The NOFIRNO® sealing system has been successfully exposed to severe pressure, shock and vibration tests.

INSTALLATION INSTRUCTIONS FOR NOFIRNO® MULTI-CABLE TRANSIT SEALING SYSTEM

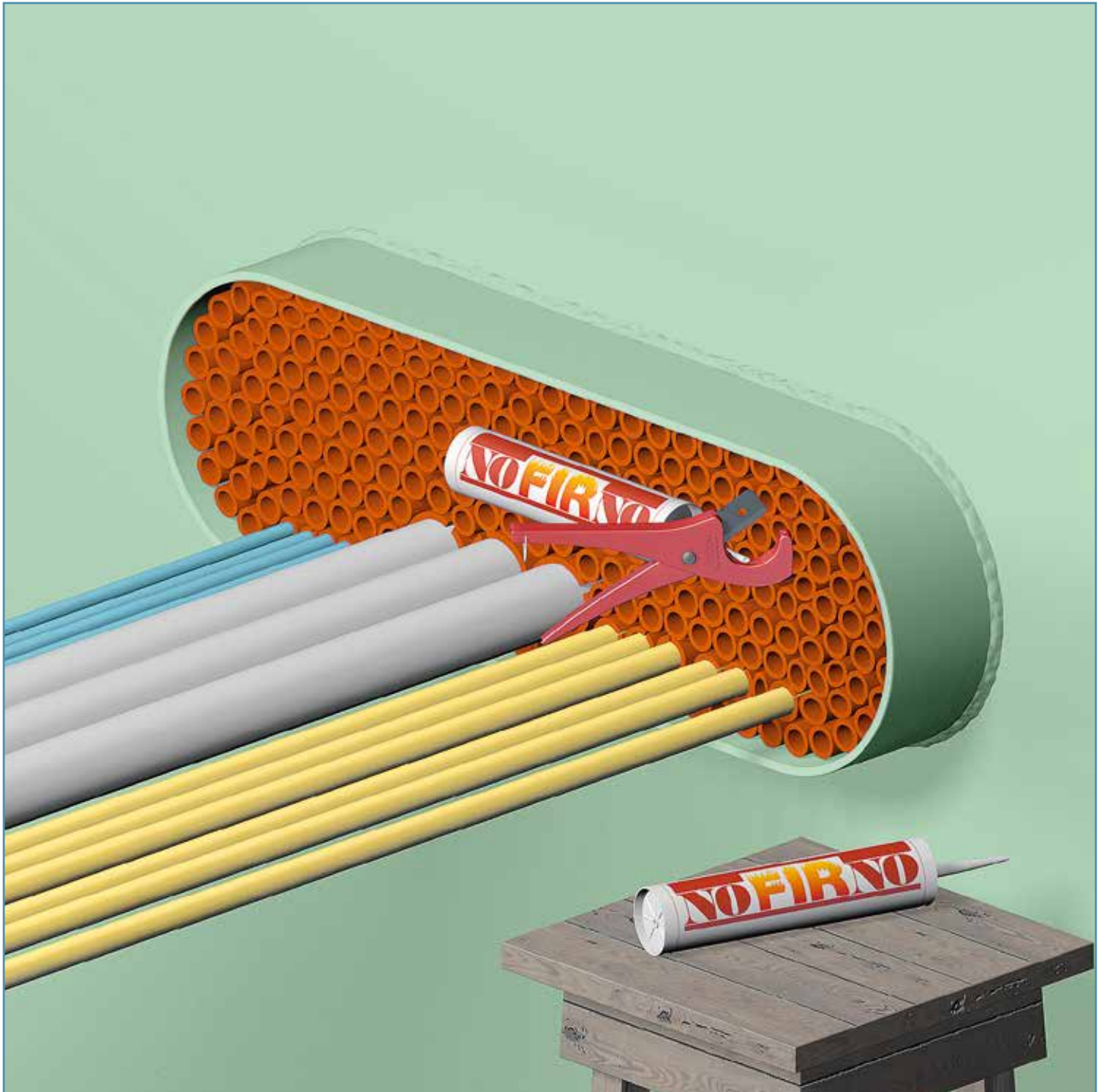

Cut the injection nozzles of the cartridges in an angled way to create a medium sized dispersing opening. This will improve the flow of the sealant in between the set of cables. Furthermore, it is advisable to use professional sealant guns. Hand fatigue is prevented, and an optimum flow of the sealant is obtained. For larger penetrations, electric or pneumatic dispensers should be used.

INSTALLATION INSTRUCTIONS FOR NOFIRNO® MULTI-CABLE TRANSIT SEALING SYSTEM

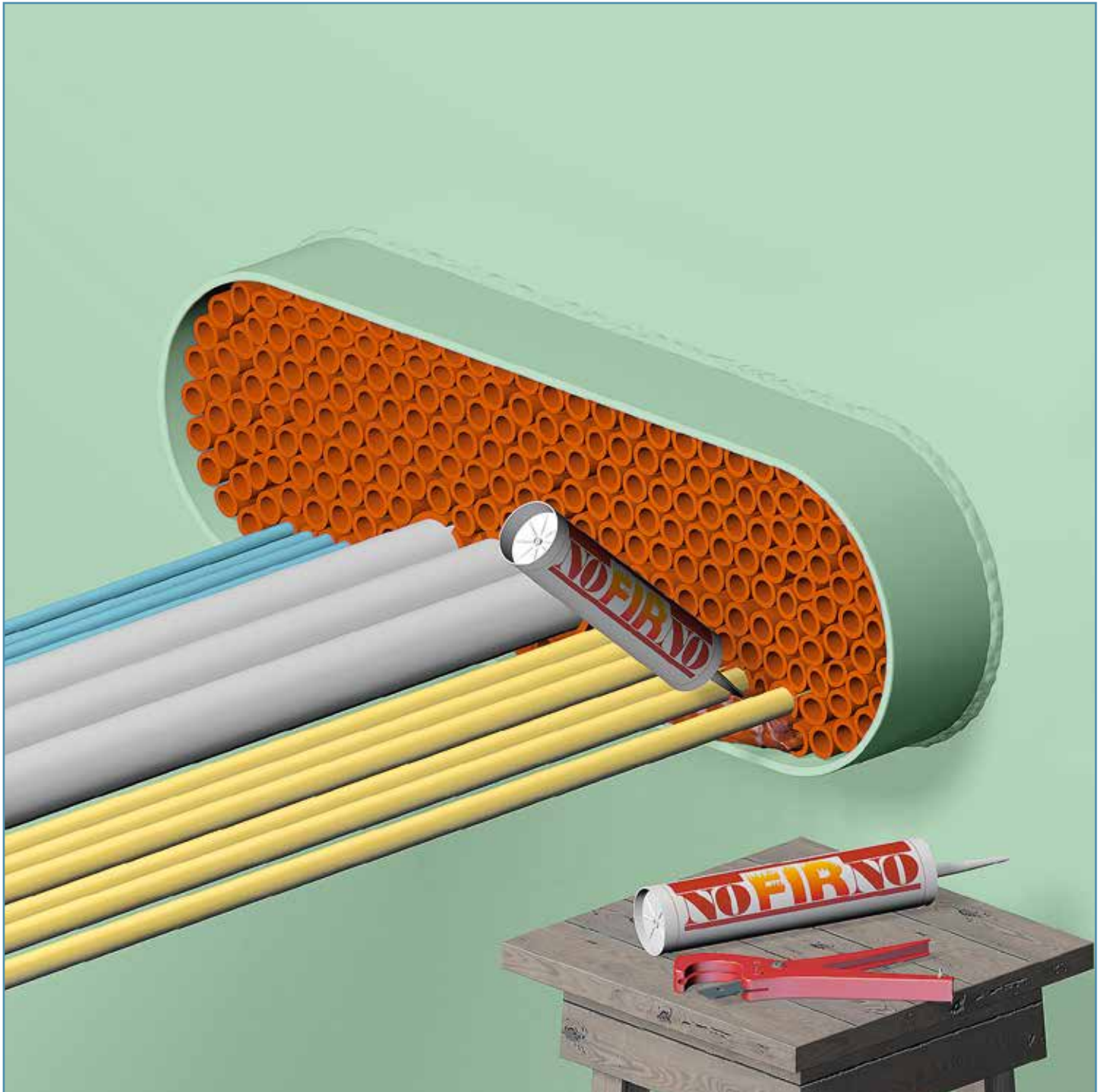

A 15 (20) mm thick layer of NOFIRNO® sealant is applied at each side of the NOFIRNO® multi-cable transit. NOFIRNO® sealant has an engineered viscosity, preventing the sealant from sagging and also allowing for a perfect flow of the sealant between the cables during injection. For multi-cable transits with a high filling rate, longer nozzles are available for the sealant cartridges.

Please refer to the Safety Data Sheet for more information about the working environment.

INSTALLATION INSTRUCTIONS FOR NOFIRNO® MULTI-CABLE TRANSIT SEALING SYSTEM

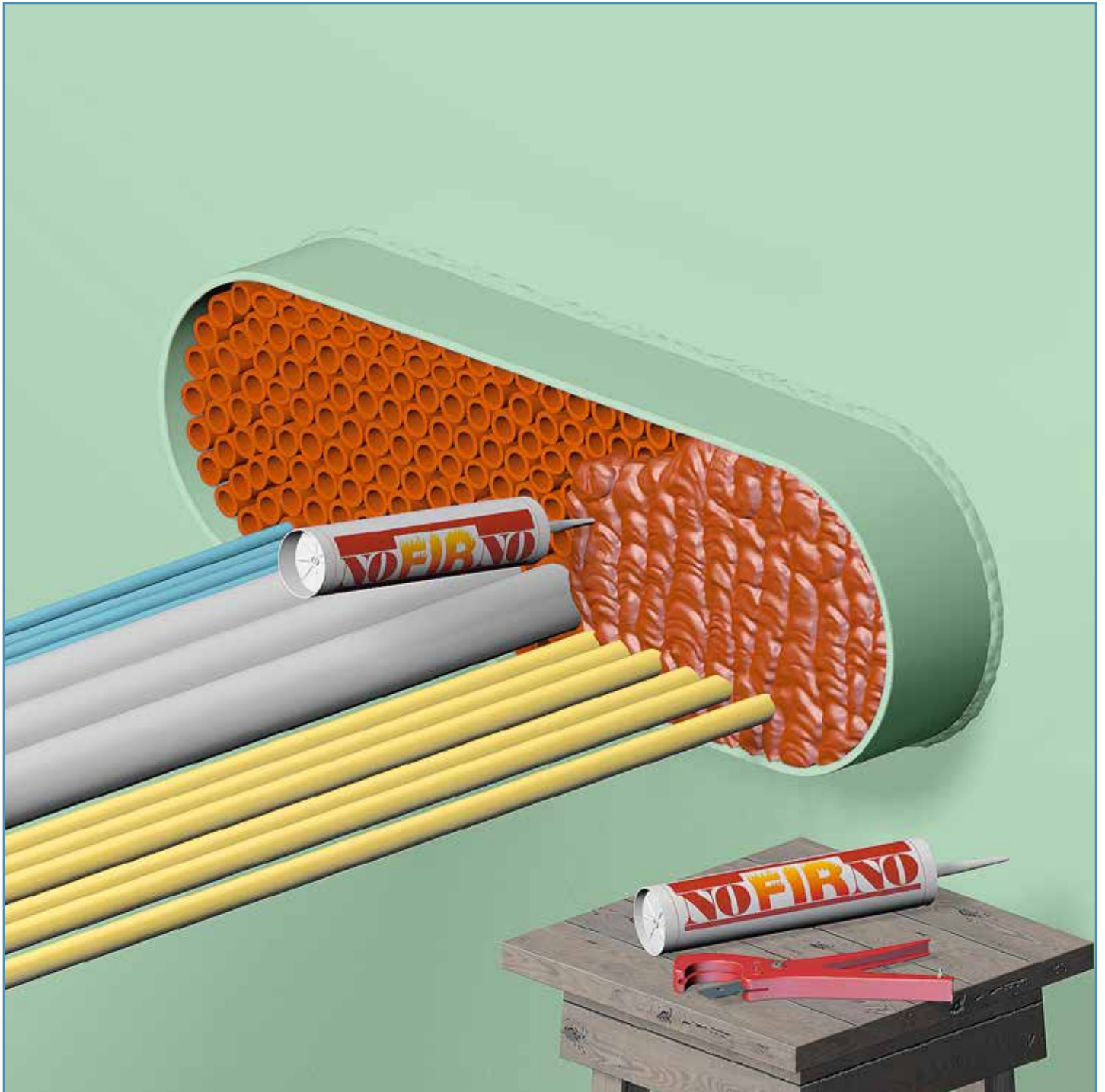

The multi-cable transit should be overfilled with NOFIRNO® sealant, because some sealant will be pushed into the empty spaces between the NOFIRNO® sleeves around the cables, and into the hollow NOFIRNO® (multi) filler sleeves during further finishing. This will contribute also to obtain higher tightness ratings.

Skin formation of the sealant takes place after ca. 10-15 minutes. In case of larger transits with a low cable filling rate, do not apply more sealant than can be finished within this time-frame.

INSTALLATION INSTRUCTIONS FOR NOFIRNO® MULTI-CABLE TRANSIT SEALING SYSTEM

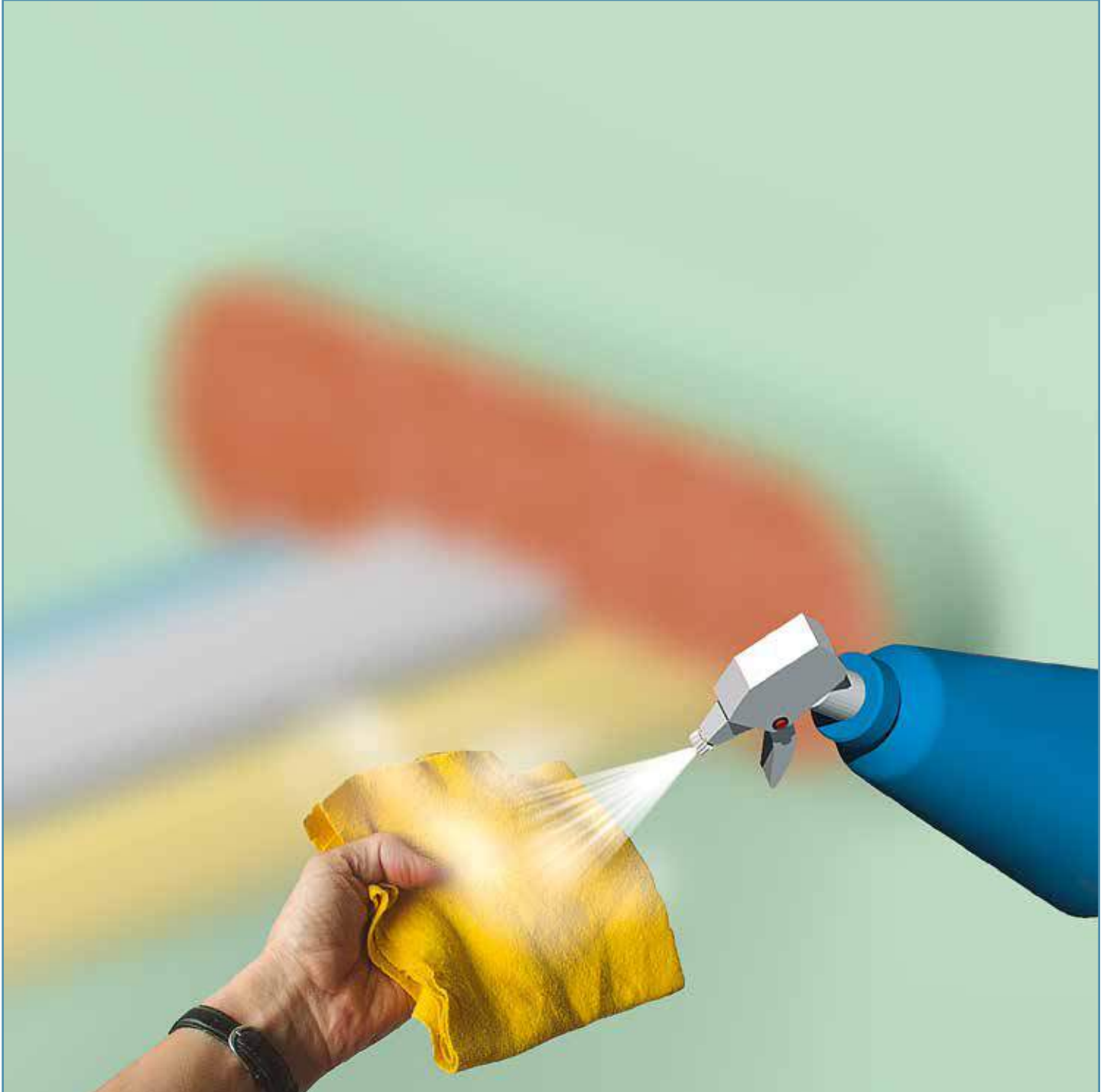

To smooth the surface of the NOFIRNO® sealant layer, a cloth is sprayed with water. This prevents the sealant from sticking to the cloth.

Please refer to the Safety Data Sheet for more information about the working environment.

INSTALLATION INSTRUCTIONS FOR NOFIRNO® MULTI-CABLE TRANSIT SEALING SYSTEM

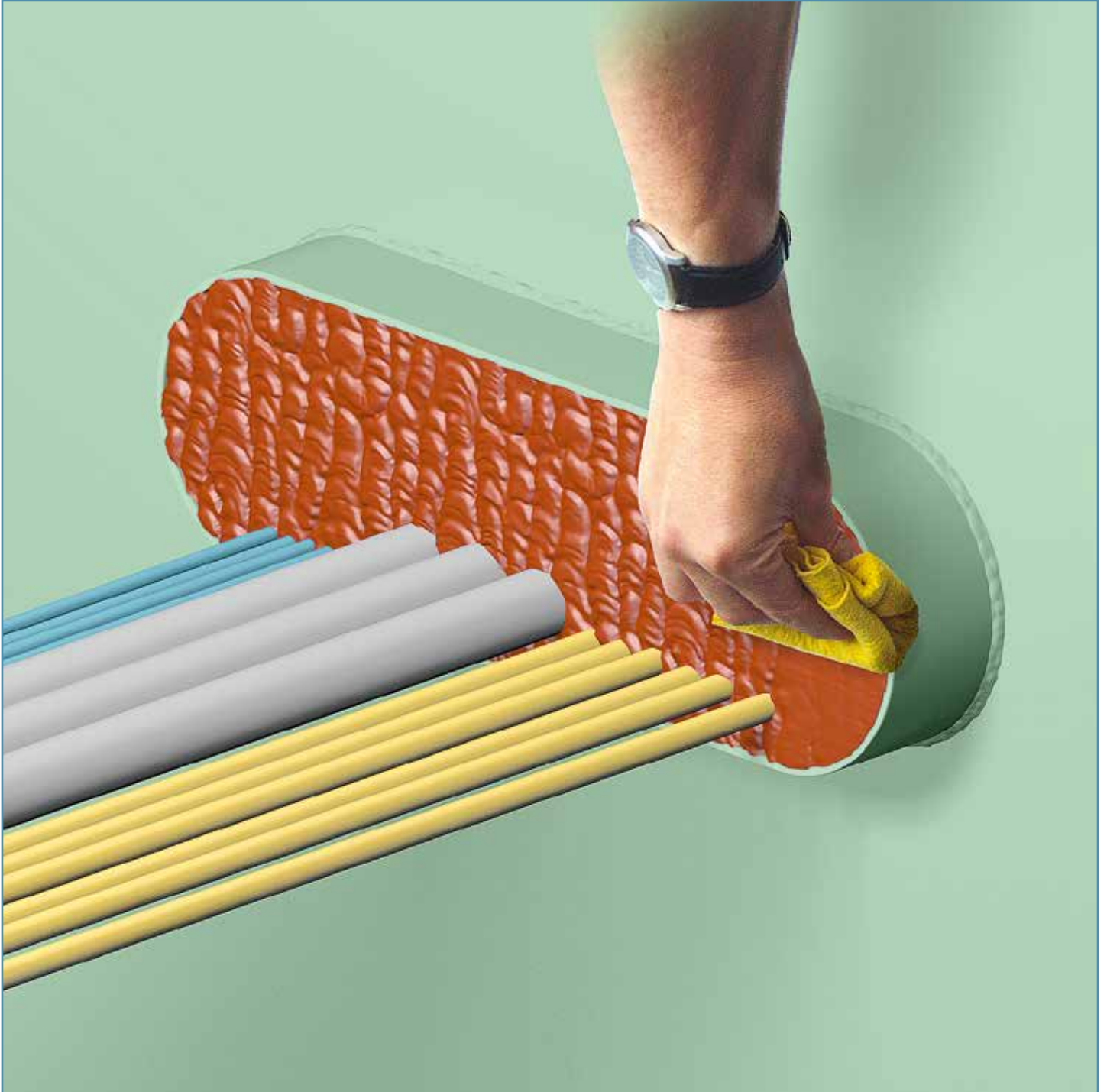

The cloth is then used to press down the sealant layer flush with the end of the transit frame. It is of utmost importance to ensure that the sealant is compressed very tightly so that the sealant is compressed into all empty spaces of the set of NOFIRNO® sleeves, including partially into the hollow filler sleeves. The larger the adhesive surfaces of the sealant, the higher the performance of the system.

INSTALLATION INSTRUCTIONS FOR NOFIRNO® MULTI-CABLE TRANSIT SEALING SYSTEM

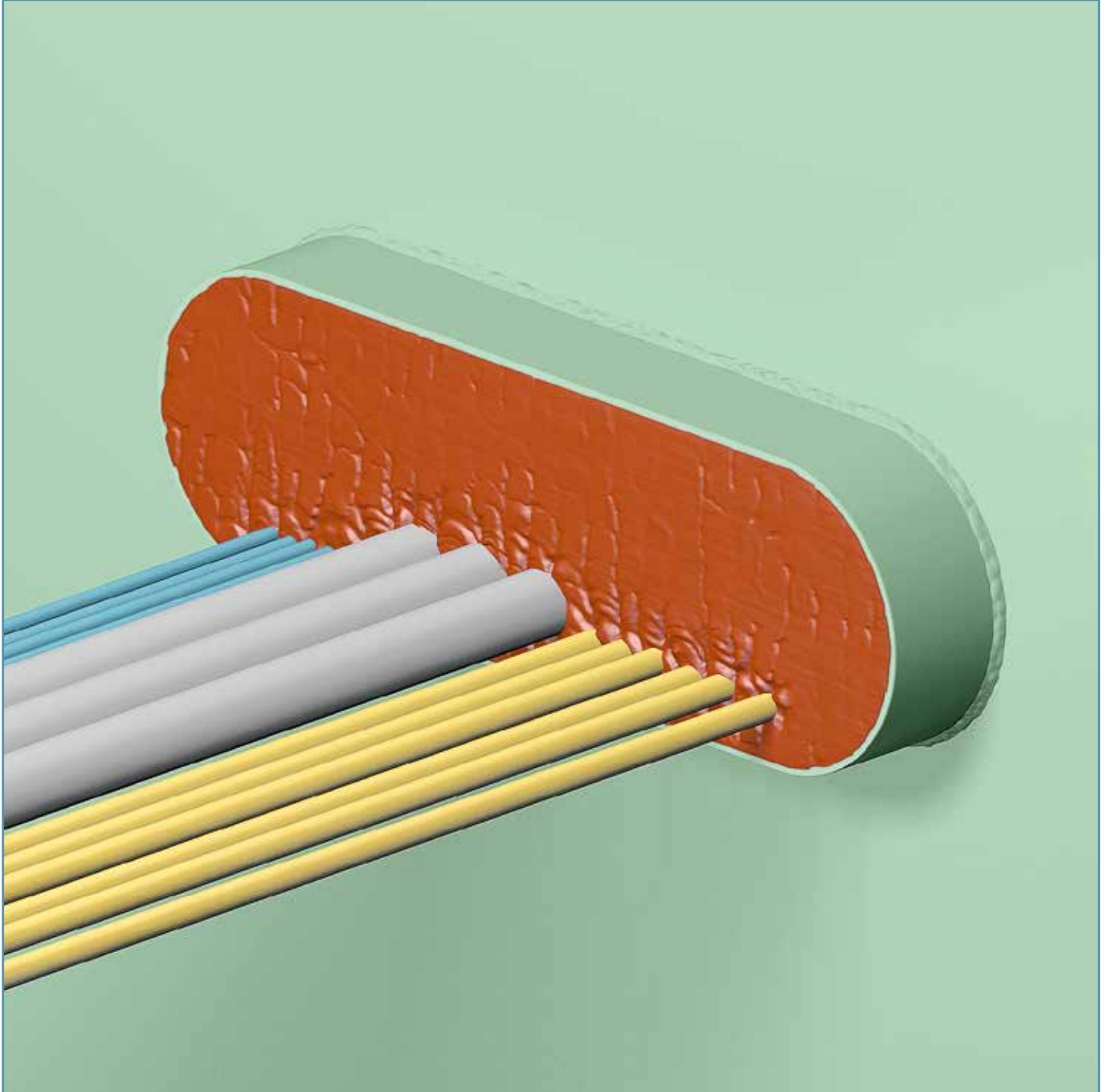

Due to the rapid skin formation of the sealant, smoothing should take place directly after compression of the sealant layer. As soon as skin formation takes place, a very neat smoothing of the sealant layer is not possible anymore.

Note: the NOFIRNO® sealant is water repellent so that water will drip off. Neat smoothing is helpful in this respect. The NOFIRNO® sealant is also seawater, UV, ozone and weathering resistant and offers a durability of decades.

INSTALLATION INSTRUCTIONS FOR NOFIRNO® MULTI-CABLE TRANSIT SEALING SYSTEM

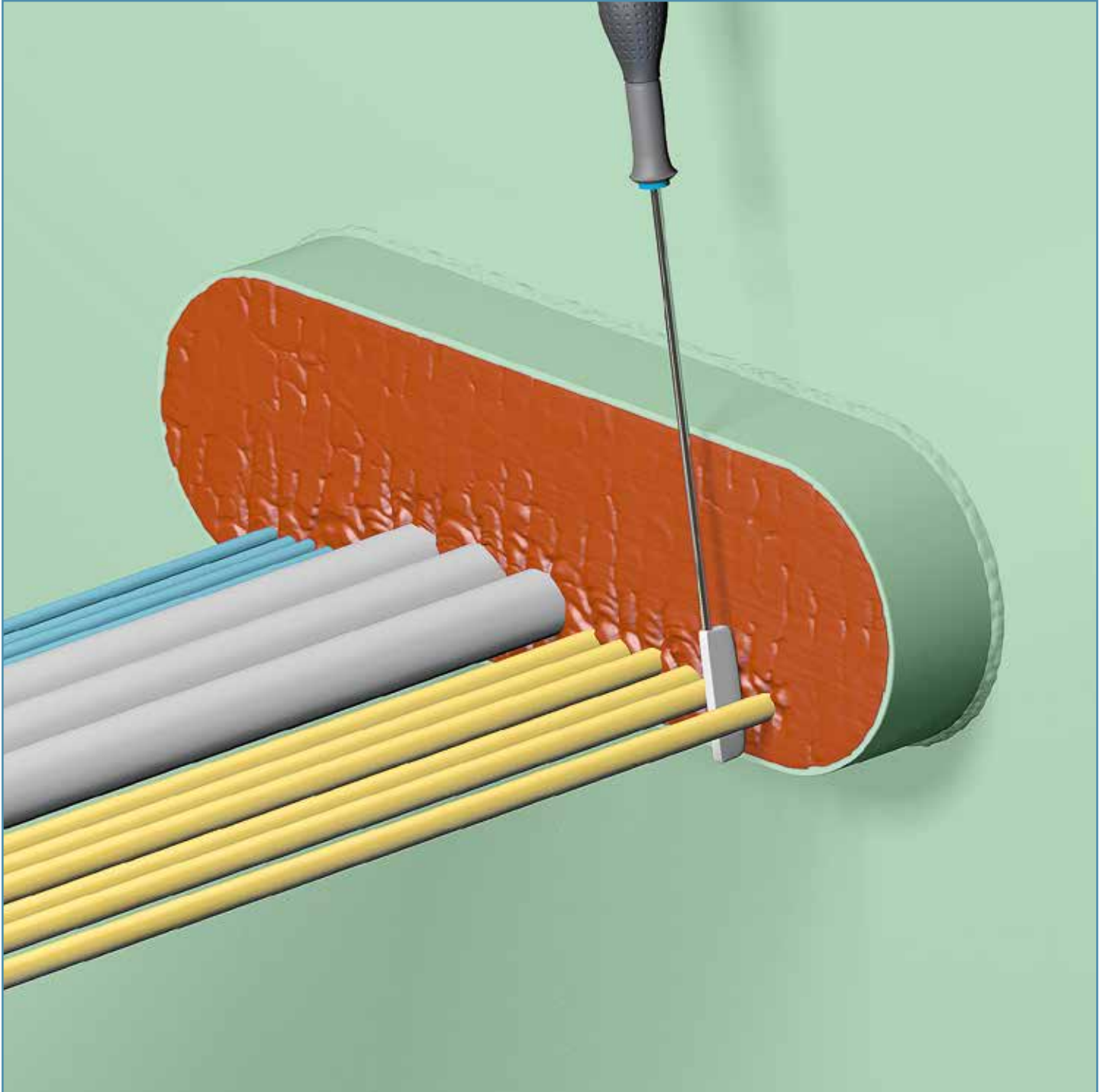

The NOFIRNO® sealant between the cables is pressed down and smoothed by hand or with a spatula or putty knife. A special tool, developed by BEELE Engineering, with a PTFE compression/smoothing part is available. The sealant will not stick to the PTFE.

Compression and smoothing, especially in between the cables, is essential to obtain an effective gas and water tightness.

INSTALLATION INSTRUCTIONS FOR NOFIRNO® MULTI-CABLE TRANSIT SEALING SYSTEM

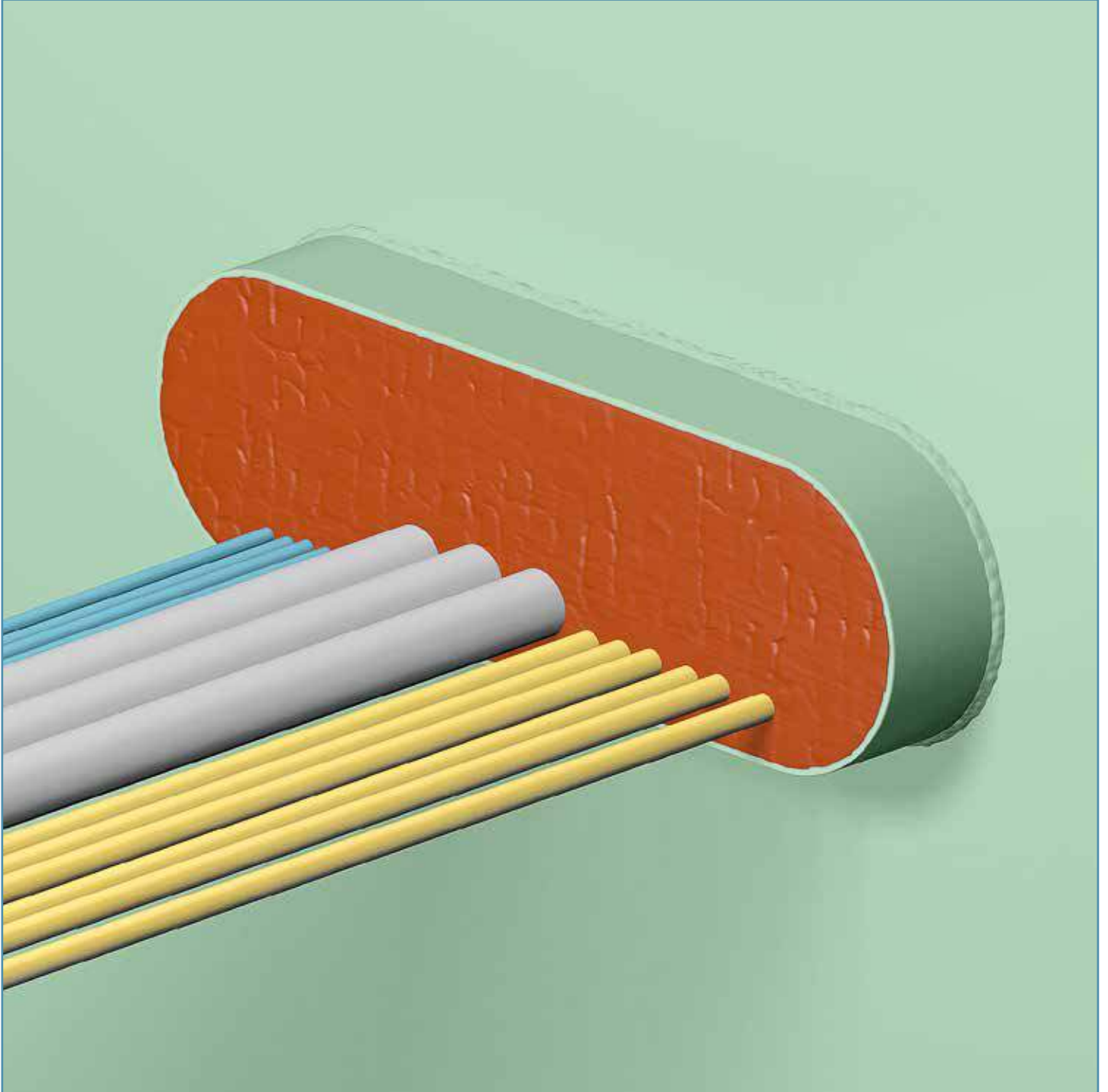

A last check should be made to ensure that the sealant layer is pressed down tightly and that no larger open holes are visible. Air enclosure within the individual layer of sealant should be prevented during finishing, because this would have a negative impact on the performance of the sealant layer under fire exposure.

Please refer to the Safety Data Sheet for more information about the working environment.

INSTALLATION INSTRUCTIONS FOR NOFIRNO® MULTI-CABLE TRANSIT SEALING SYSTEM

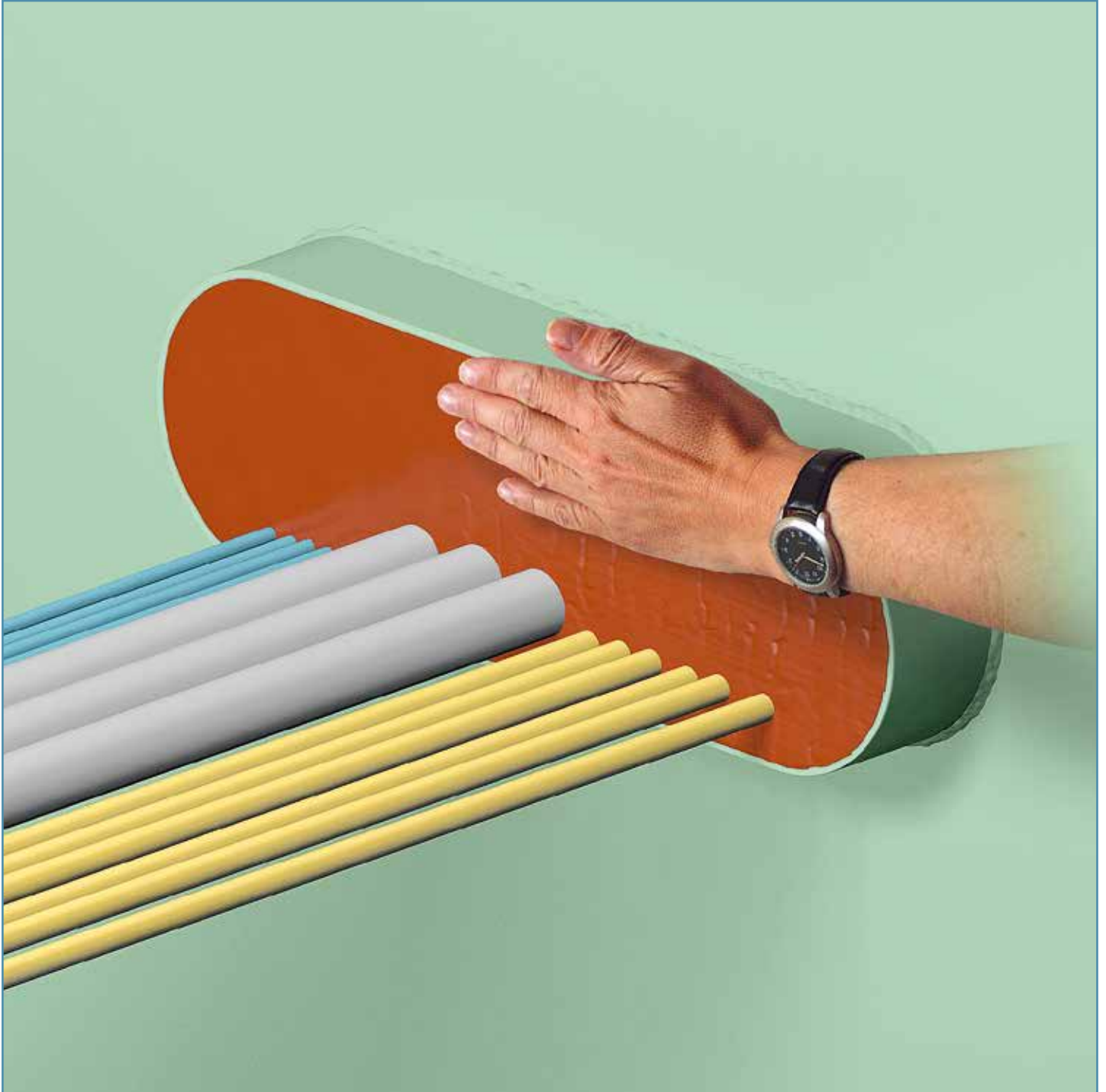

The surface can be smoothed by hand. Just wet the hands thoroughly with water. No dirty hands when working with NOFIRNO® and a very neat surface is the result. Note: this should only be a smoothing procedure. Do not pack or compress the sealant further.

Wear protective gloves when working with NOFIRNO® sealant. Please refer to the Safety Data Sheet for more information.

INSTALLATION INSTRUCTIONS FOR NOFIRNO® MULTI-CABLE TRANSIT SEALING SYSTEM

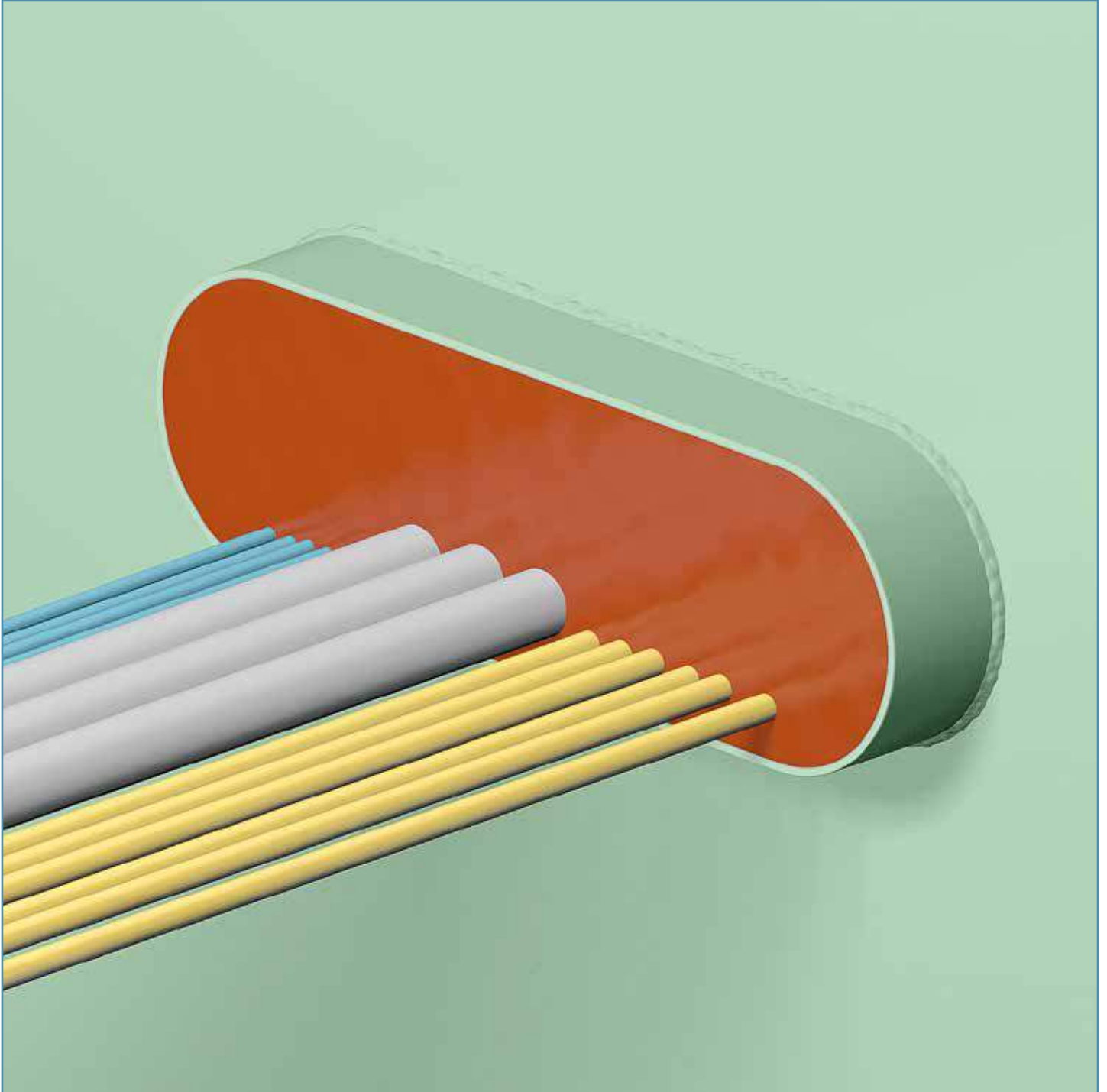

To obtain optimum adhesion during the curing process of the sealant, all the cables should be tightly fixed at both sides of the transit, as close as possible to the transit, and immediately after finishing the transit. Movement of the cables during the curing process will impair the adhesion process to the cable sheathings.

Note: time needed for curing of the sealant is dependent on air humidity in combination with the environmental temperature. It is advisable to place a sticker near the finished transit, stating that the transit has been recently installed, and should not be touched or damaged.

INSTALLATION INSTRUCTIONS FOR NOFIRNO® MULTI-CABLE TRANSIT SEALING SYSTEM

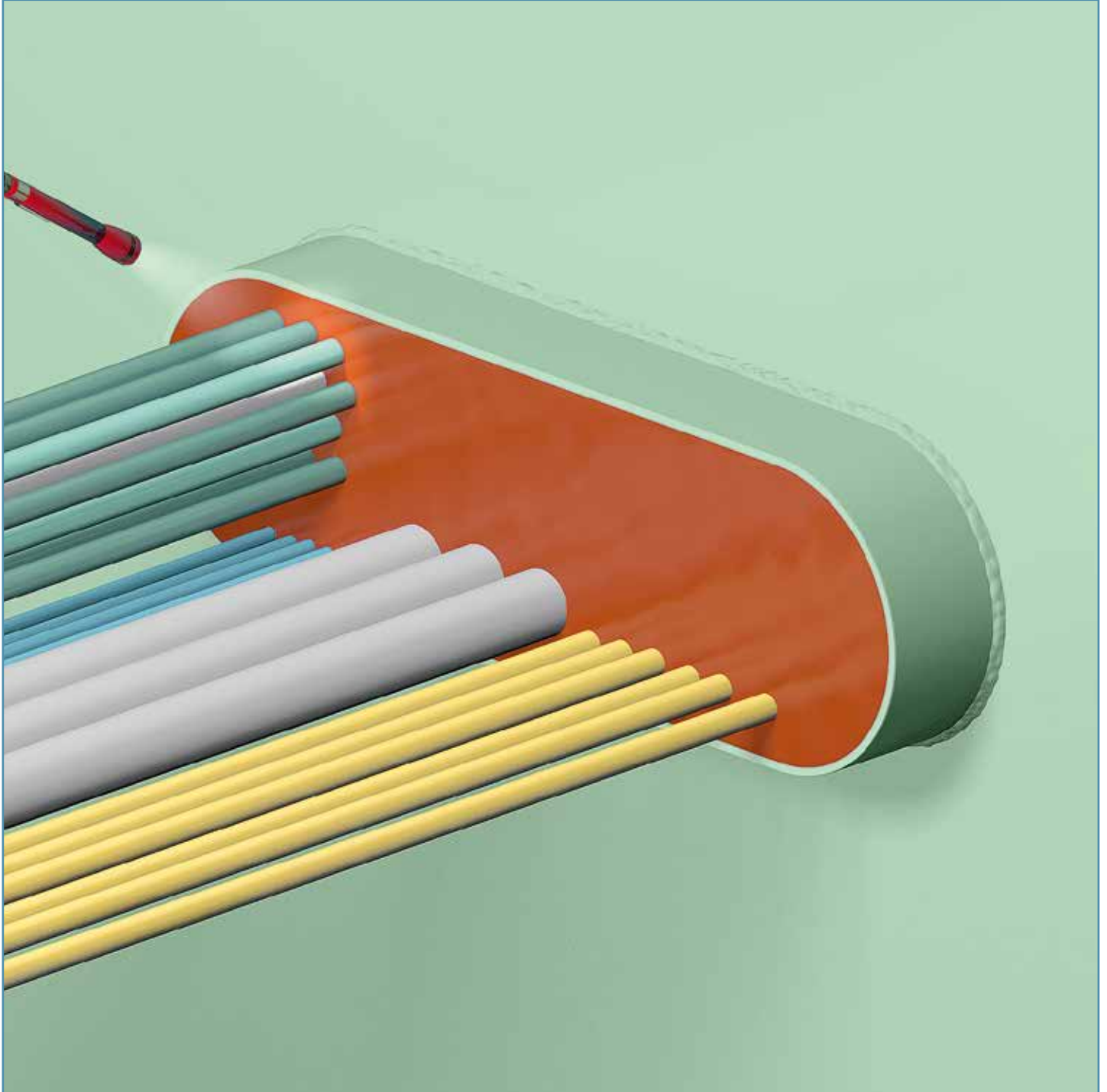

Additional information: applying the sealant on highly filled multi-cable transits can be quite complicated. The sealant can be applied in layers from the bottom to the top after cable pulling. Regardless, checking if sufficient sealant is applied in between sets of cables close to each other is a must. The reflective colour of the NOFIRNO® has the advantage that visual inspection of the sealant application in between cables is easier to perform. Water and gas tightness is dependent on the quality of the final sealing. As is the case with any system, workmanship has a direct impact on the performance of the sealing system.

INSTALLATION INSTRUCTIONS FOR NOFIRNO® MULTI-CABLE TRANSIT SEALING SYSTEM

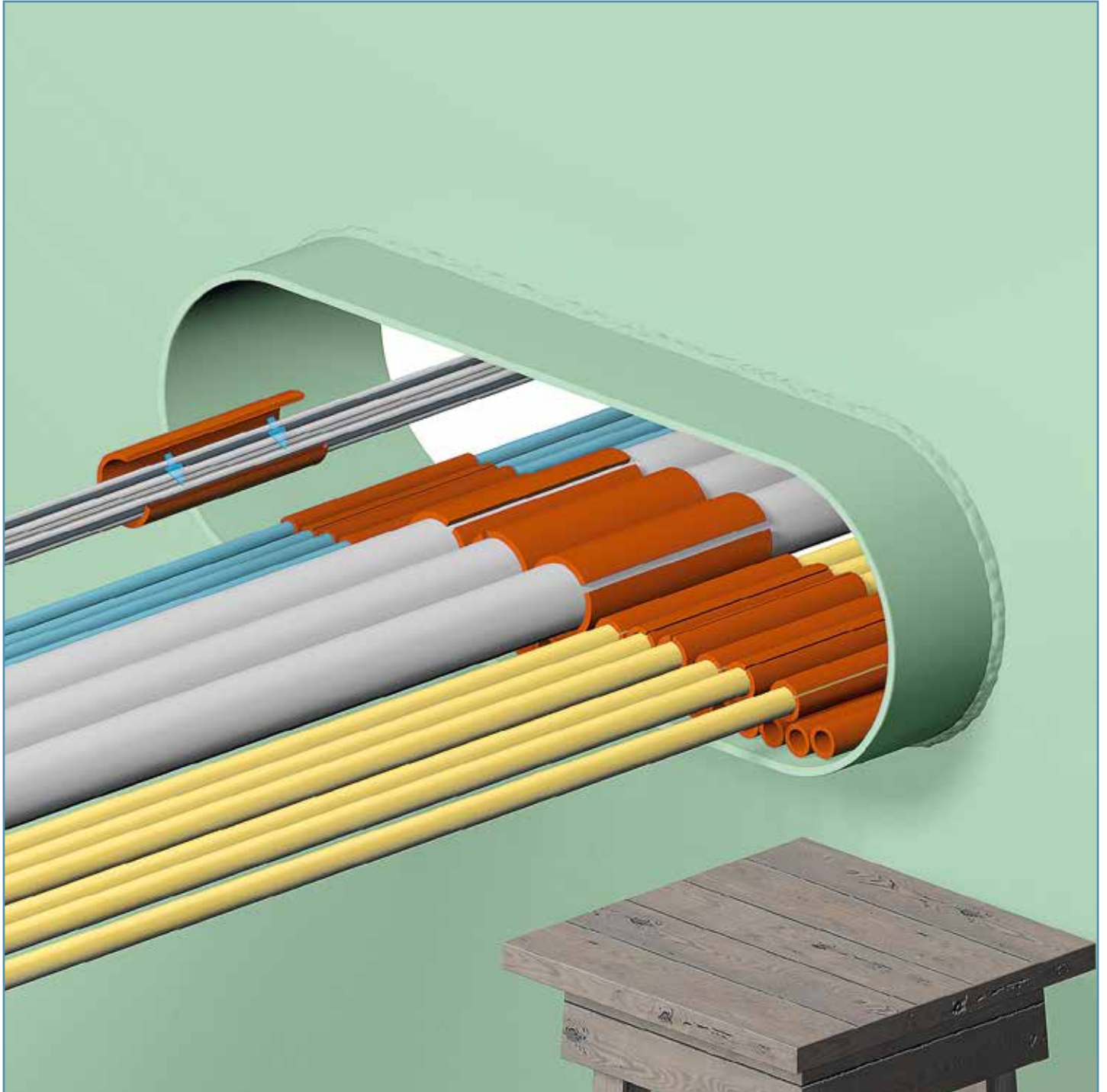

Additional information: bundled cable sets are allowed in the NOFIRNO® multi-cable sealing system, using only a single NOFIRNO® insert sleeve around the bundle of cables.
Note: see the approved installation drawings for details. Bundling is limited to approved maximum dimensions.

INSTALLATION INSTRUCTIONS FOR NOFIRNO® MULTI-CABLE TRANSIT SEALING SYSTEM

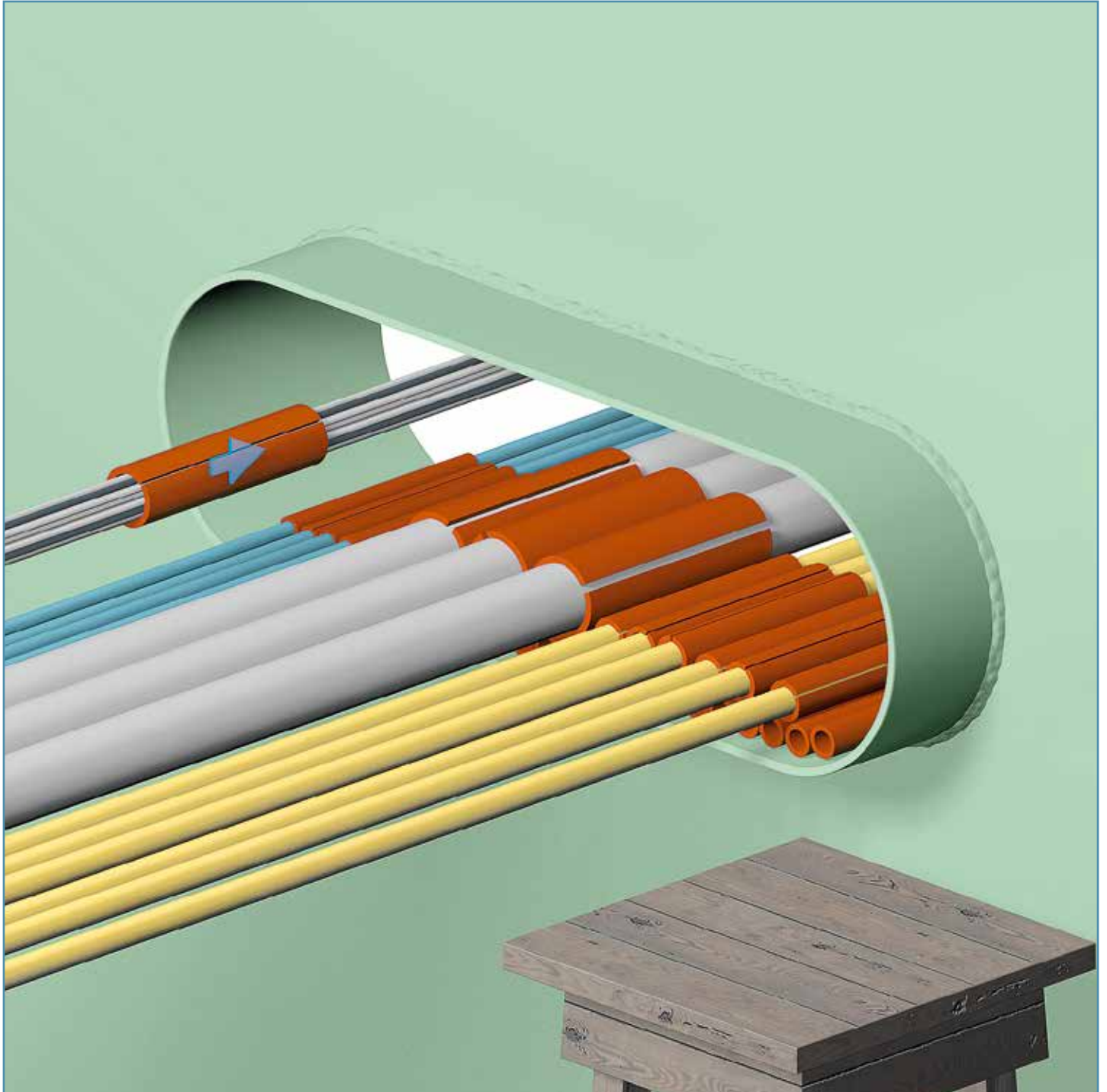

The sleeve is then pushed into the transit leaving 15 (20) mm free at front and backside.

Note: NOFIRNO® multi-cable transits with bundled cables are not approved for watertight partitions.

INSTALLATION INSTRUCTIONS FOR NOFIRNO® MULTI-CABLE TRANSIT SEALING SYSTEM

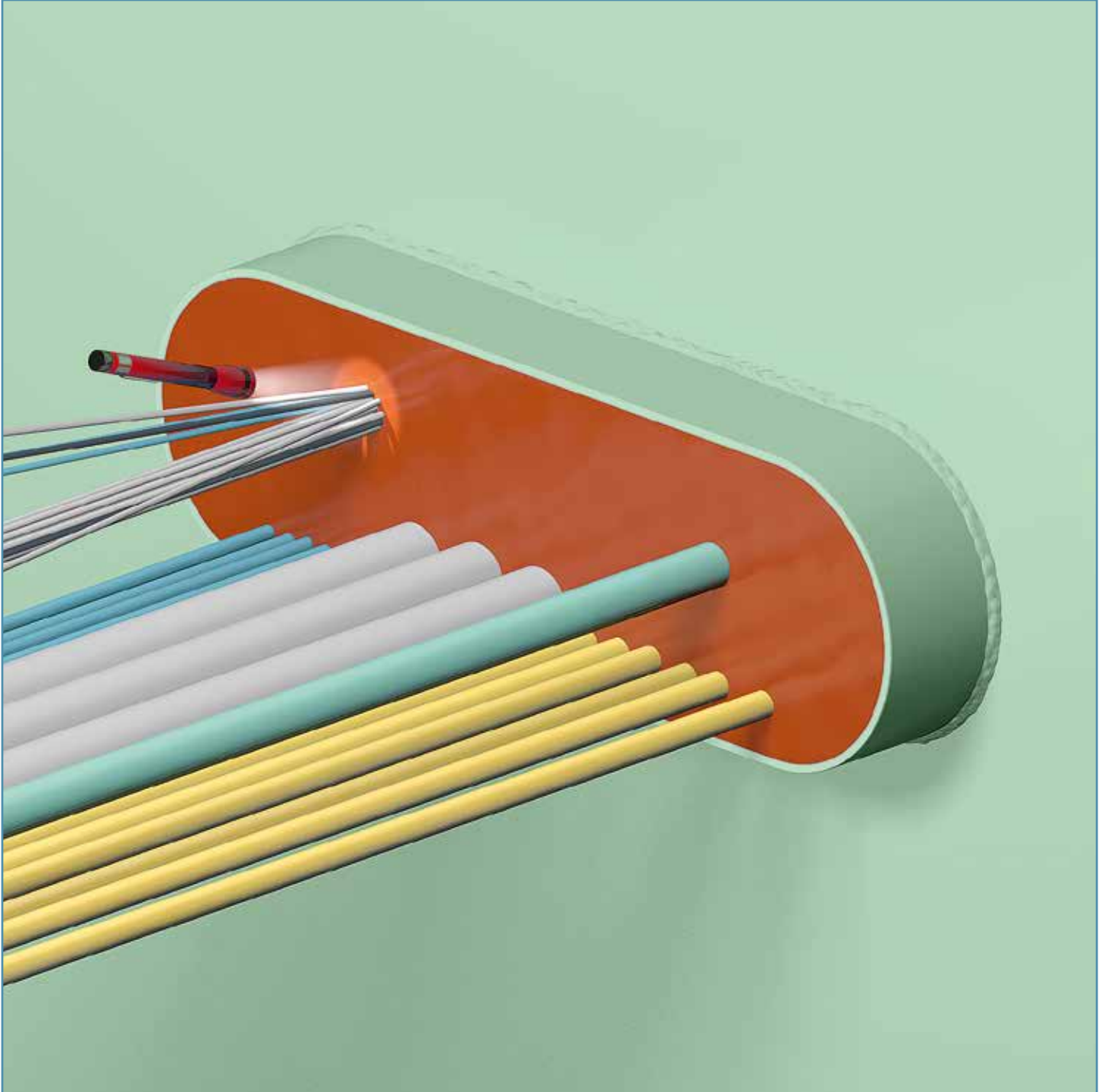

Check for all certainty that the sealant has been well packed around the bundle of cables in order to ensure an appropriate degree of cold smoke tightness. The NOFIRNO® rubber is highly endothermic and will not be consumed by the fire.

INSTALLATION INSTRUCTIONS FOR NOFIRNO® MULTI-CABLE TRANSIT SEALING SYSTEM

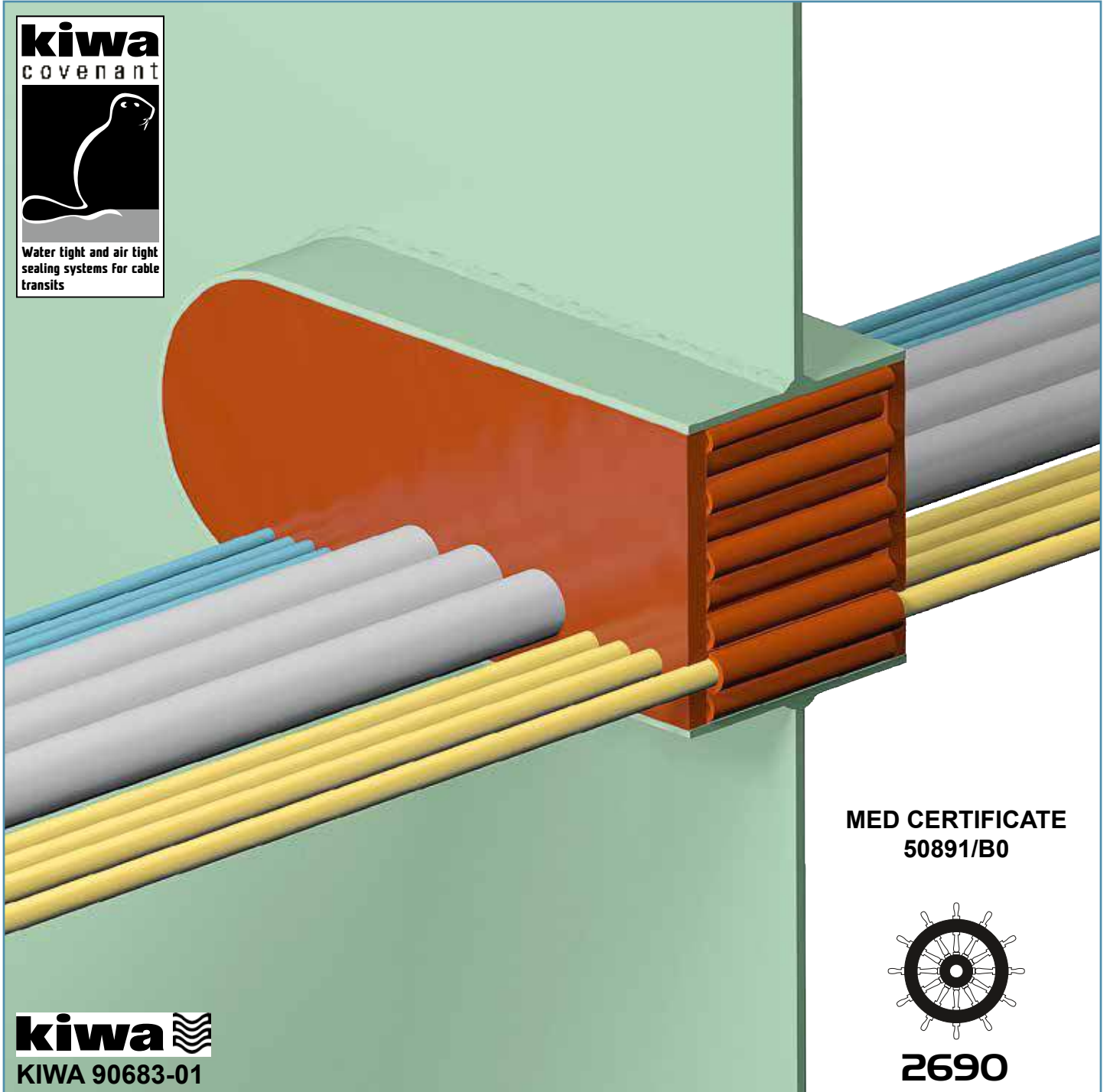

The NOFIRNO® rubber grade of the sleeves and the NOFIRNO® sealant, which are compounded under strict conditions in our factory, are suitable for gas and water tight ducting, and for fire rated applications as well. The NOFIRNO® sealant stays flexible at temperatures of -50 °C, allowing application in arctic environments.

The NOFIRNO® multi-cable transits have excellent resistance to seawater, UV, ozone and weather. Based on the use of the high tech silicone composition of the NOFIRNO® sealant and rubber, the system offers excellent durability.

INSTALLATION INSTRUCTIONS FOR NOFIRNO® MULTI-CABLE TRANSIT SEALING SYSTEM

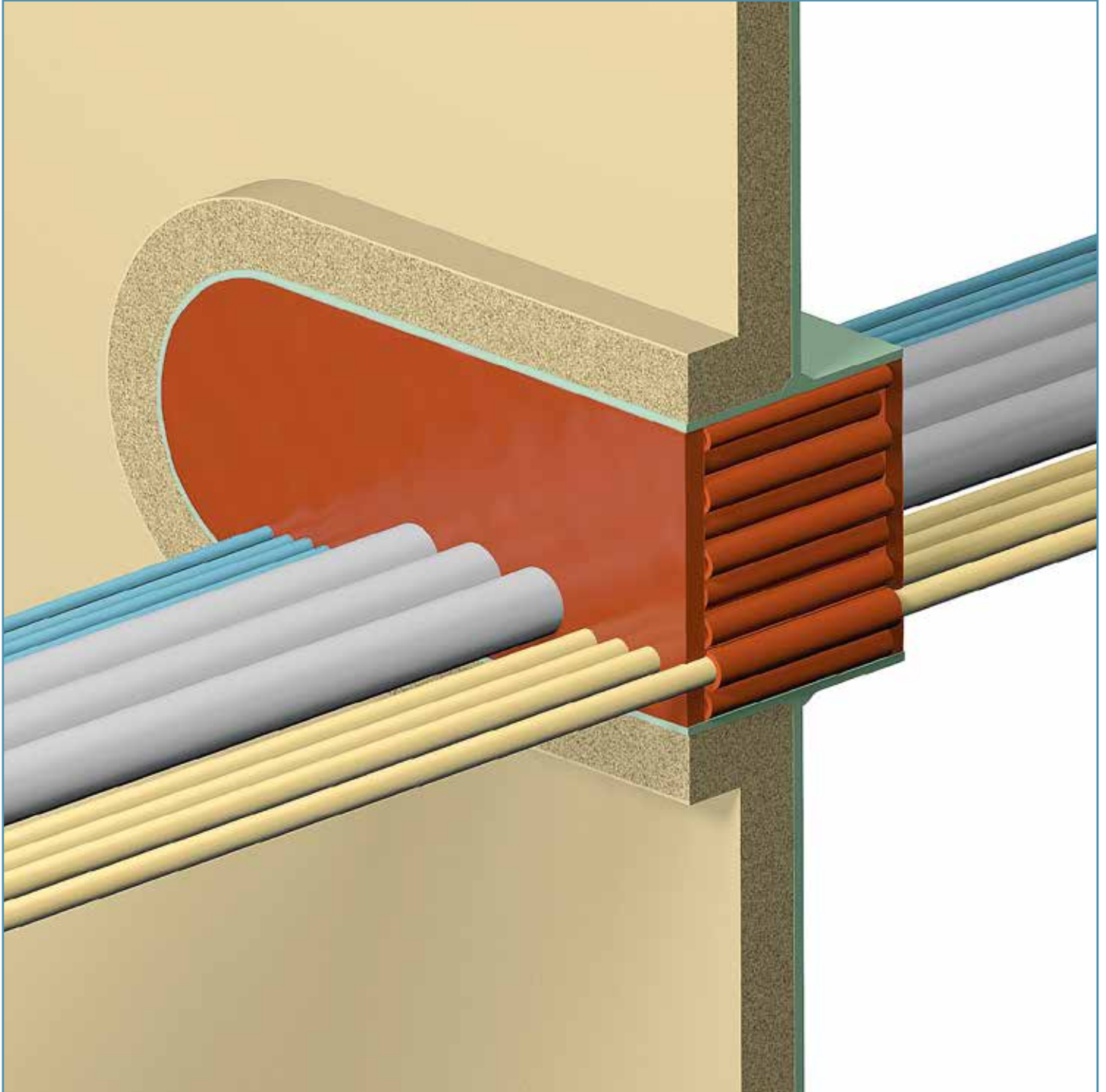

For A-class penetrations (which are insulated), the NOFIRNO® multi-cable transit frame needs to be insulated only at the insulated side of the bulkhead. No extra insulation needed in front of the transit and/or in between the cables. Tested with larger amounts LAN data cables (bundled as well), up to CLX high voltage cables up to 3 x 380 mm² with an OD of 105 mm. Note: for the larger cable sizes, NOFIRNO® cable wraps have to be used. Also approved for A-0 class without any insulation. No metal parts are incorporated in the sealing system. The conduit frames cannot corrode inside due to the tight sealant layers at both sides of the transit. No CUI (Corrosion Underneath Insulation).

INSTALLATION INSTRUCTIONS FOR NOFIRNO® MULTI-CABLE TRANSIT SEALING SYSTEM

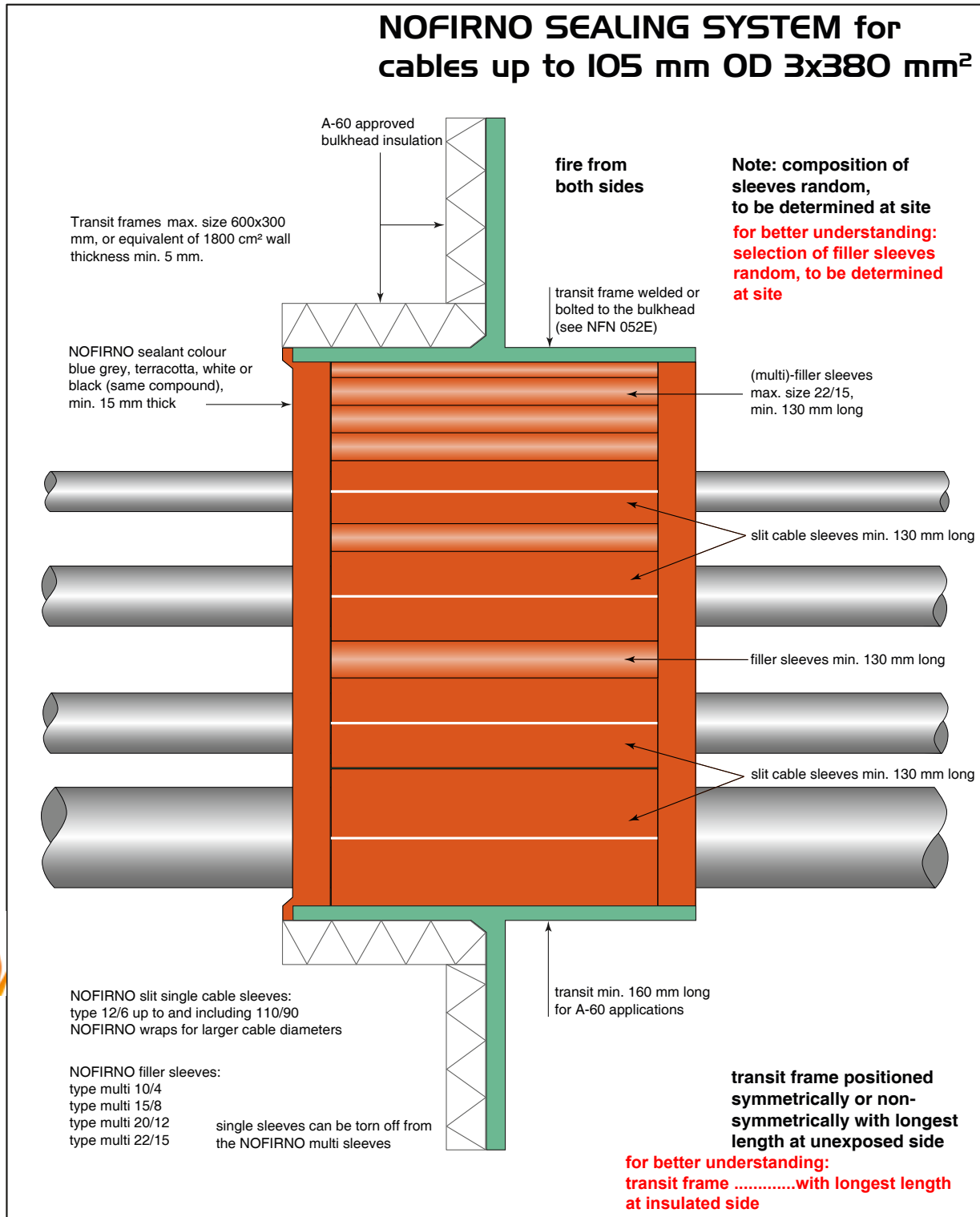

	Description: NOFIRNO sleeve type multi-cable transit system for A-60 class bulkhead transits			
	Mat.: NOFIRNO rubber & sealant			
Ref.: JAB	Date:	22-04-17	Scale: 1 : 2	
No part of this document may be reproduced by photocopy, print, microfilm or any means without the written permission of BEELE Engineering bv of The Netherlands	Rev. 1		NFN 050E	
	Rev. 2			

INSTALLATION INSTRUCTIONS FOR NOFIRNO® MULTI-CABLE TRANSIT SEALING SYSTEM (DECK)

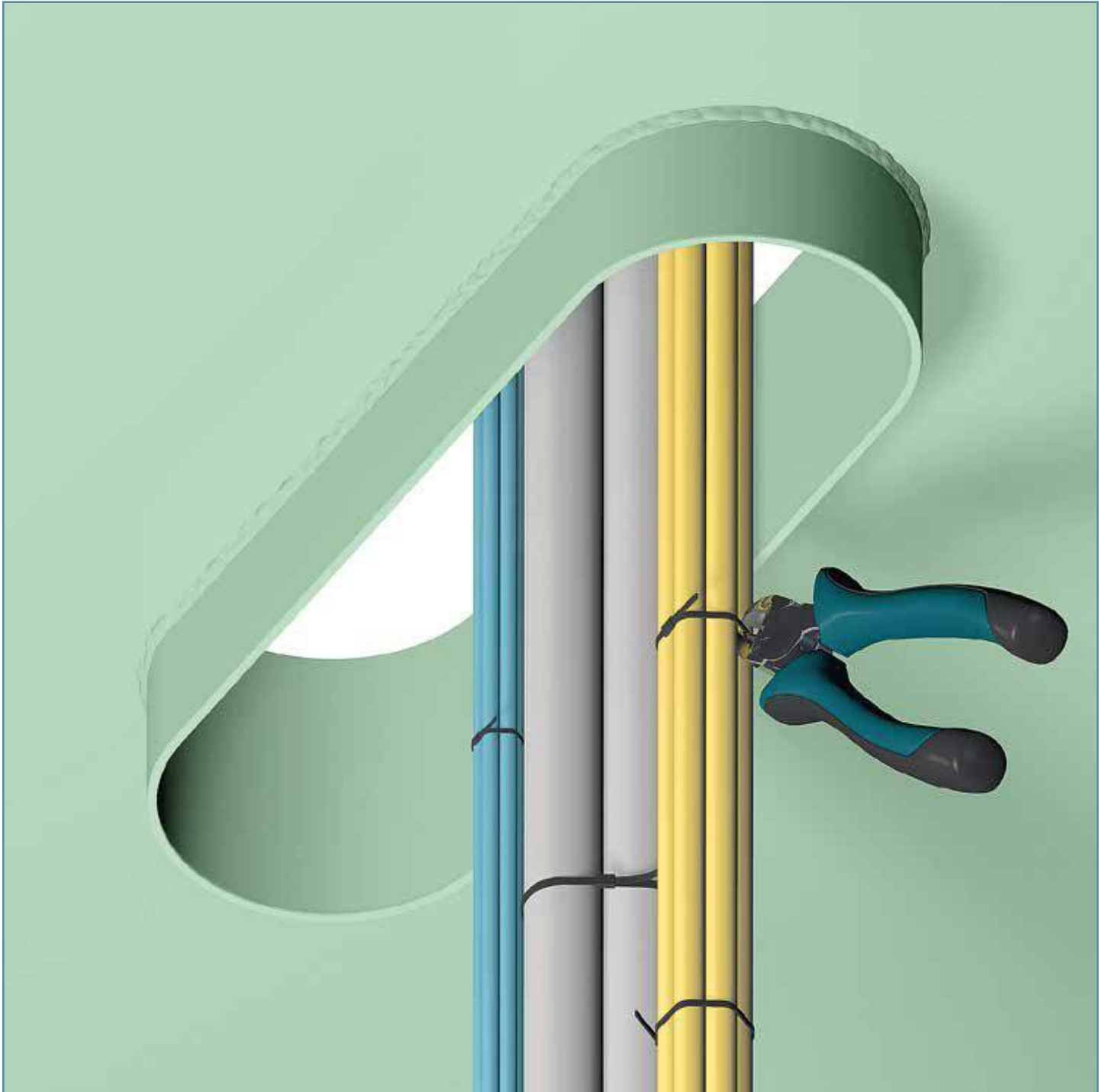

Deck penetrations are also easy to install with the NOFIRNO® system. Remove any cable tie-wraps to provide sufficient play of the cable set.

INSTALLATION INSTRUCTIONS FOR NOFIRNO® MULTI-CABLE TRANSIT SEALING SYSTEM (DECK)

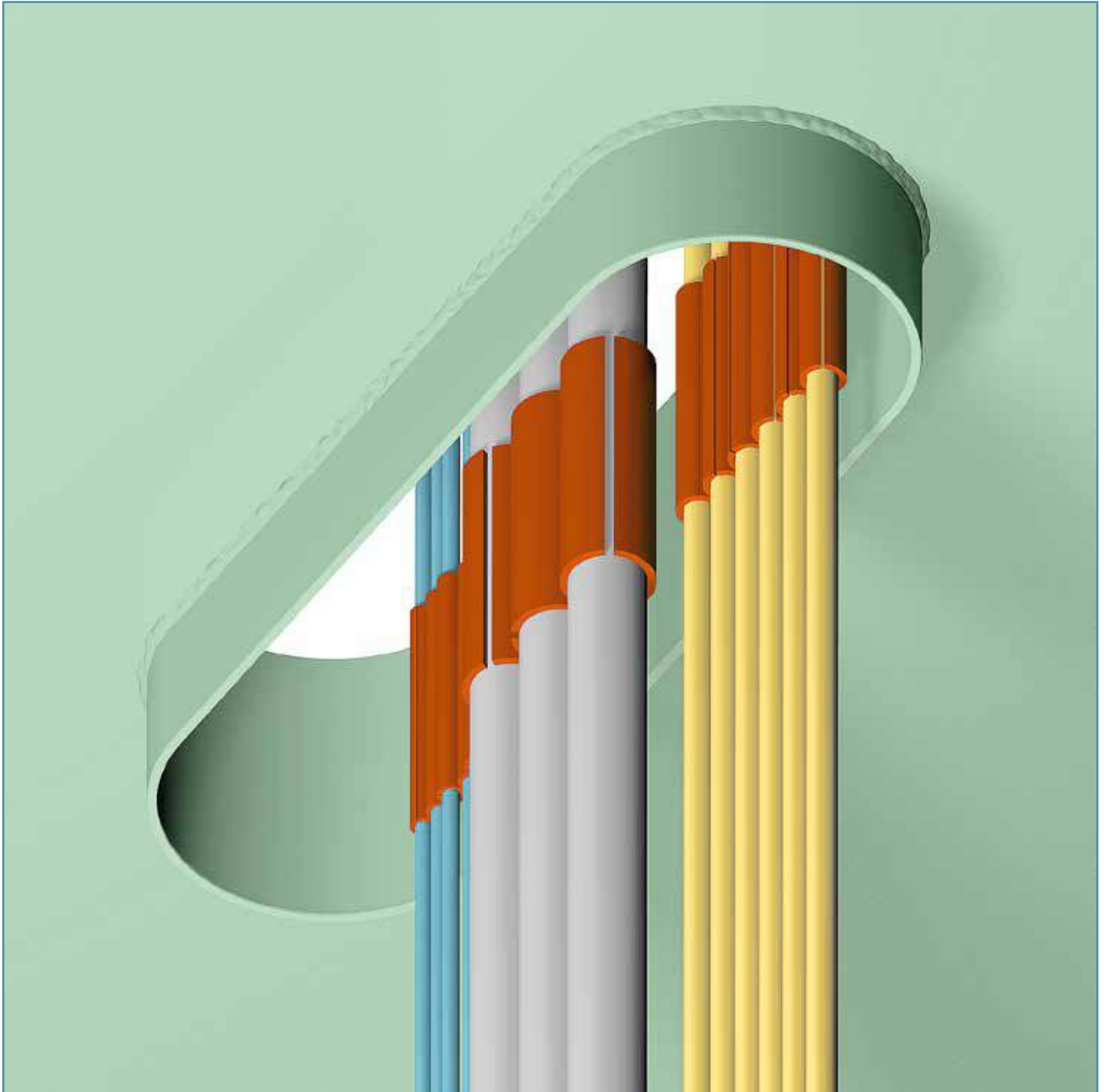

To prevent the NOFIRNO® sleeves from sliding down the cables, the sleeve should be a bit undersized to the cable. This allows the sleeves to cling to the cables, preventing them from sliding down. The inner surface structure of the NOFIRNO® cable sleeves will hold the sleeves in place as well.

INSTALLATION INSTRUCTIONS FOR NOFIRNO® MULTI-CABLE TRANSIT SEALING SYSTEM (DECK)

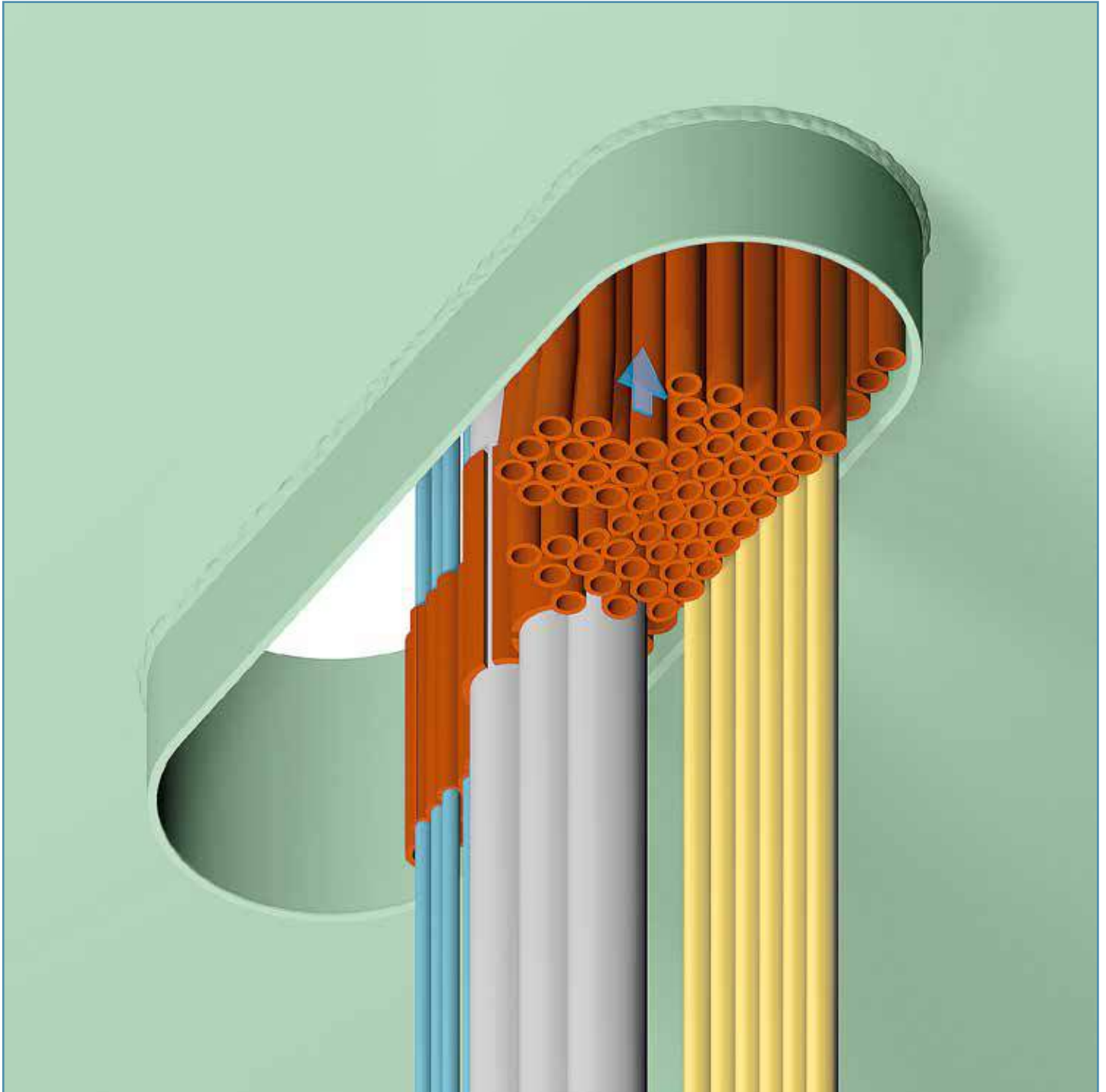

By making use of the NOFIRNO® multi-filler sleeves, sets and bundles can be made to ensure tight fitting inside the transit. With NOFIRNO® single filler sleeves, the filling of larger vertical transits will be more difficult.

INSTALLATION INSTRUCTIONS FOR NOFIRNO® MULTI-CABLE TRANSIT SEALING SYSTEM (DECK)

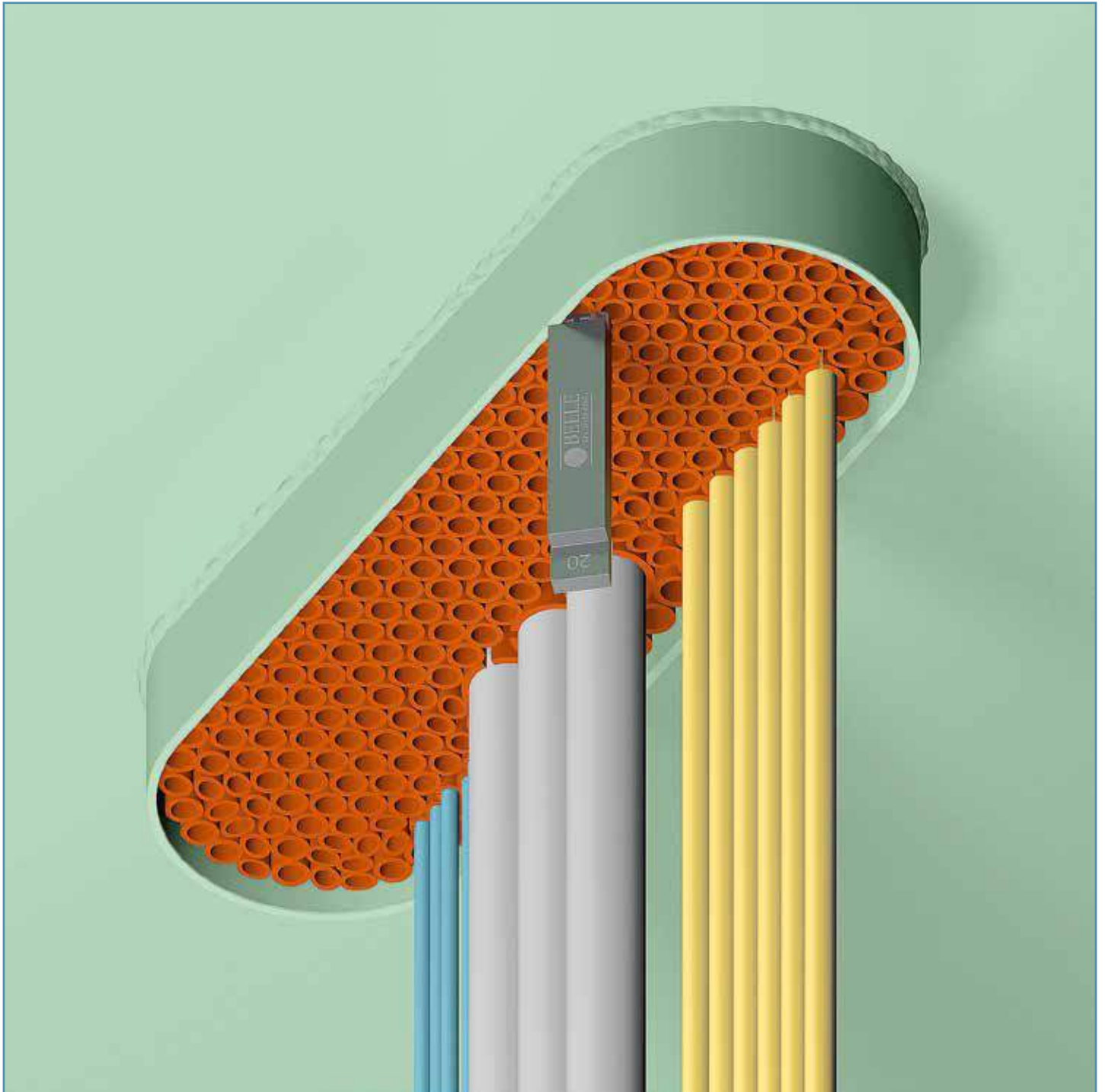

With the Beele® adjuster or a marked piece of wood, the set of fillers is adjusted inside the transit. The NOFIRNO® rubber grade and the NOFIRNO® sealant, which are compounded under strict conditions in our factory, are suitable for gas and water tight ducting, and for highest fire rated applications as well. NOFIRNO® sleeves and sealant stay flexible at temperatures of -50 °C, allowing application in arctic environments even better than RISE®, and can be exposed to temperatures up to +180 °C as well.

INSTALLATION INSTRUCTIONS FOR NOFIRNO® MULTI-CABLE TRANSIT SEALING SYSTEM (DECK)

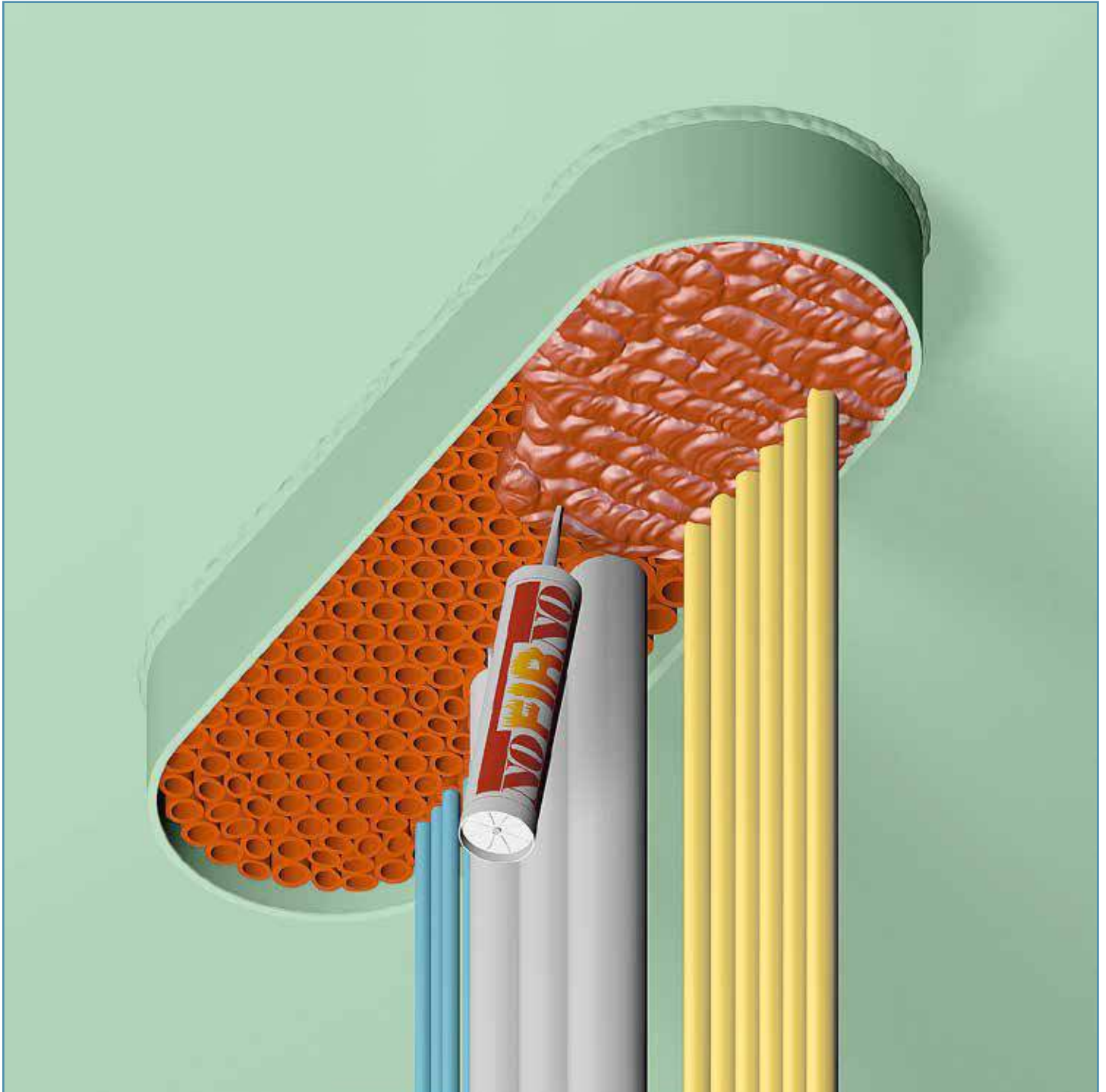

The NOFIRNO® sealant can be applied overhead for deck/floor transits without dripping or sagging. For cable transits with a high filling rate, longer nozzles for the sealant cartridges are available.

Please refer to the Safety Data Sheet for more information about the working environment.

INSTALLATION INSTRUCTIONS FOR NOFIRNO® MULTI-CABLE TRANSIT SEALING SYSTEM (DECK)

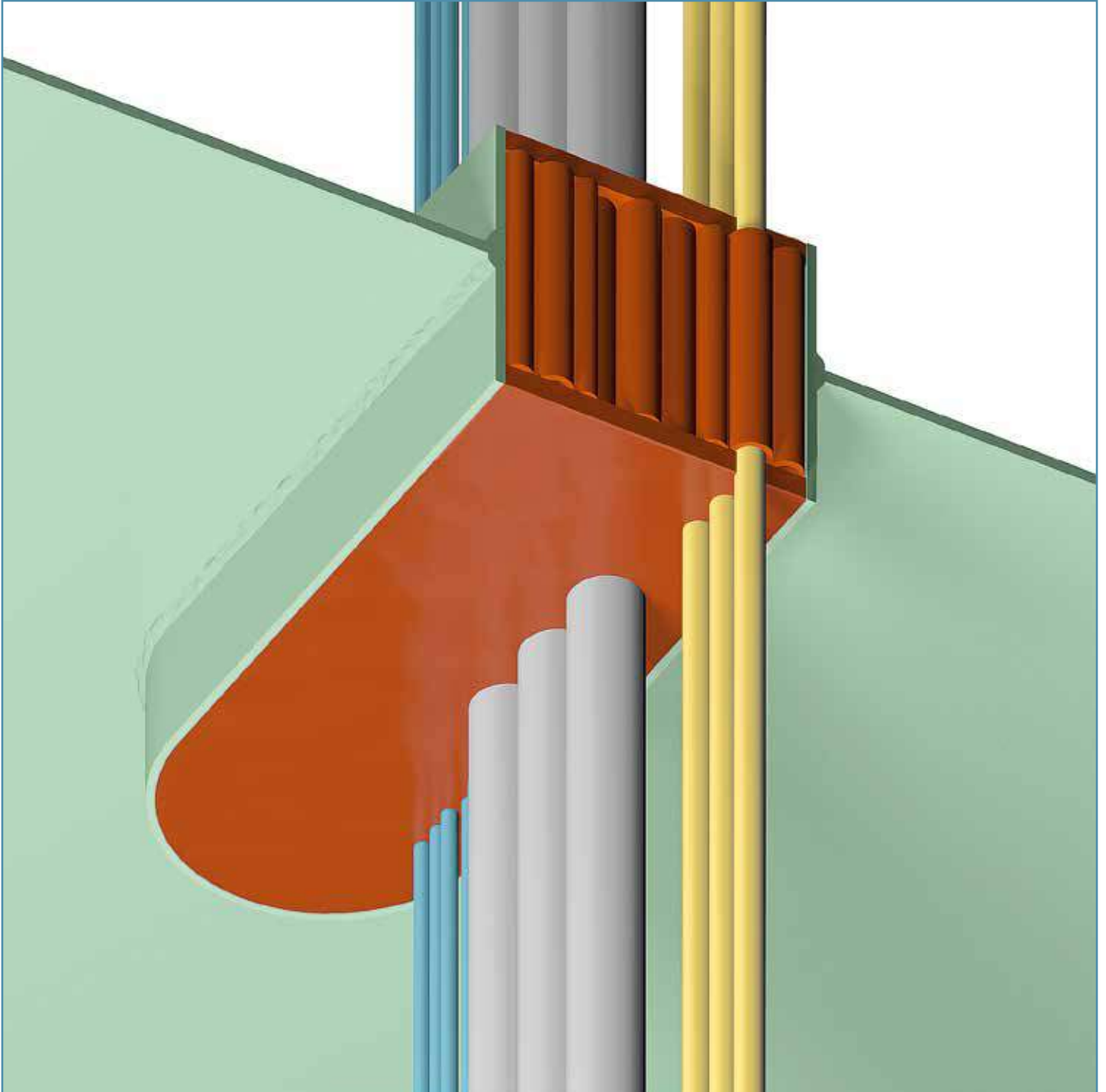

The surface can be smoothed by hand. Just wet the hands thoroughly with water. No dirty hands when working with NOFIRNO® and a very neat surface is the result. Note: this should only be a smoothing procedure. Do not pack or compress the sealant further.

Wear protective gloves when working with NOFIRNO® sealant. Please refer to the Safety Data Sheet for more information

INSTALLATION INSTRUCTIONS FOR NOFIRNO® MULTI-CABLE TRANSIT SEALING SYSTEM (DECK)

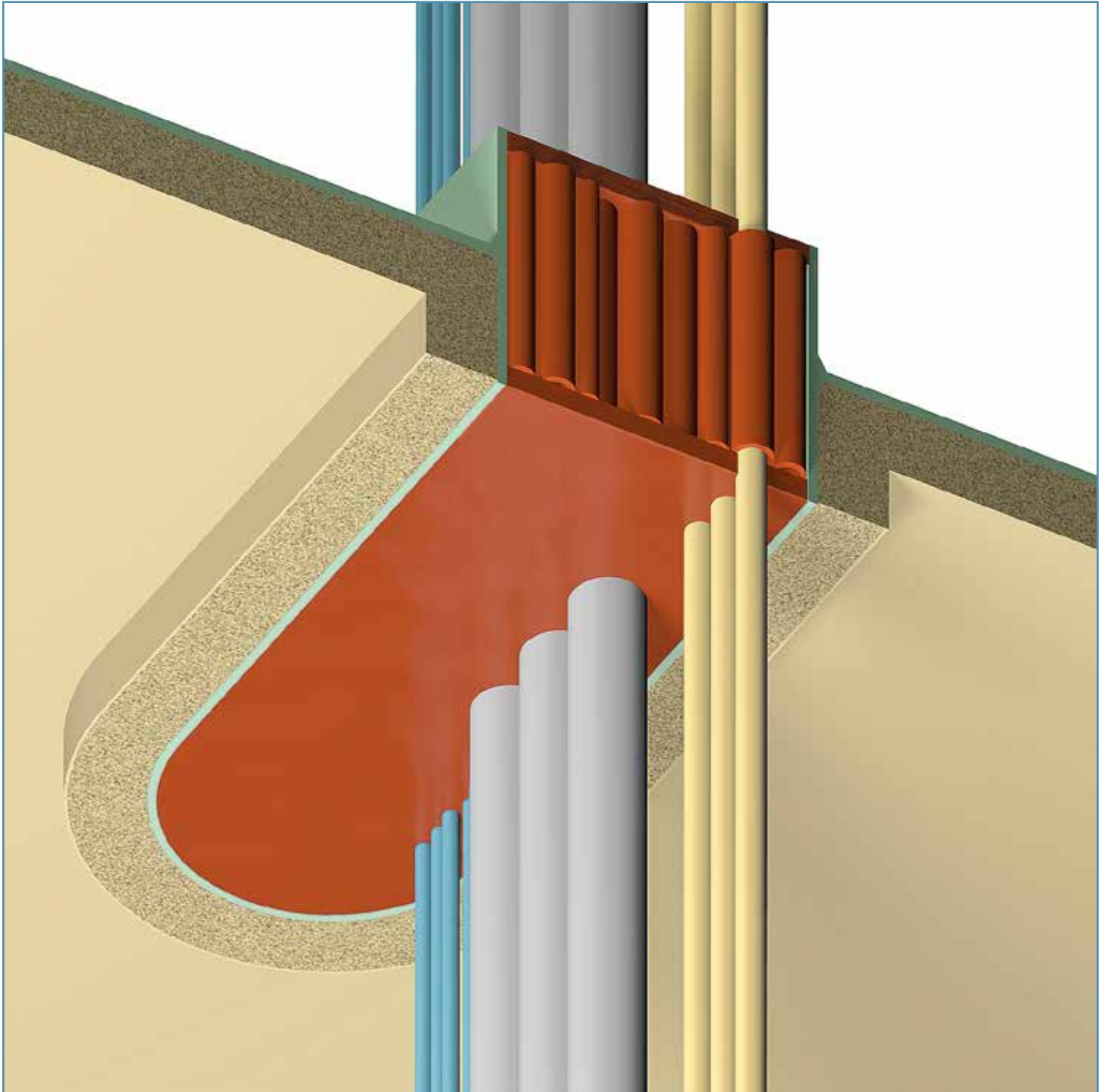



For A-class penetrations (which are insulated), the NOFIRNO® multi-cable transit frame needs to be insulated only at the at the lower side of the deck.

No extra insulation needed in front of the penetration and/or in between the cables. Tested with larger amounts LAN data cables (bundled as well), up to CLX high voltage cables with conductors up to 3 x 380 mm² with an OD of 105 mm.

Note: for the larger cable sizes, NOFIRNO® cable wraps have to be used.

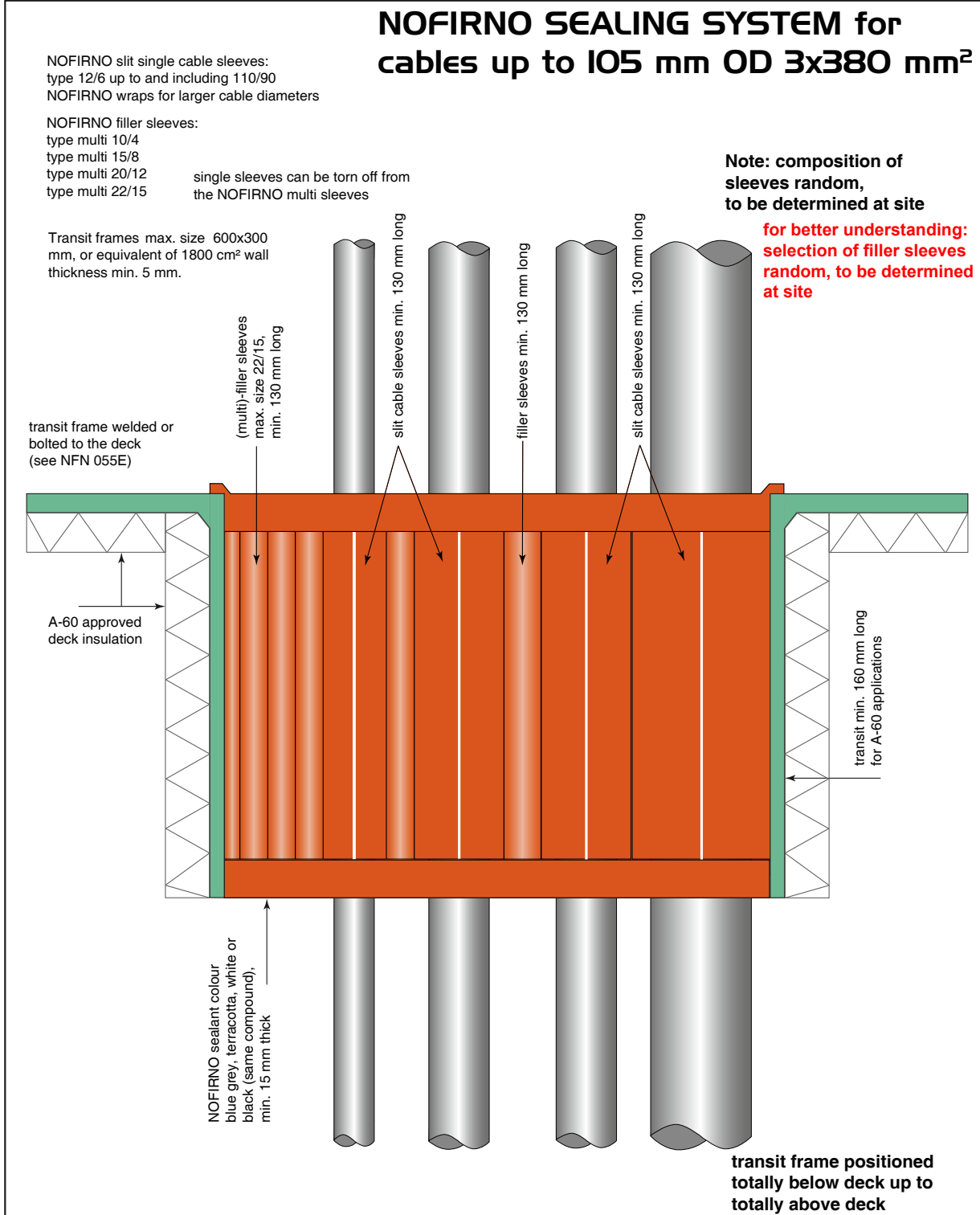
INSTALLATION INSTRUCTIONS FOR NOFIRNO® MULTI-CABLE TRANSIT SEALING SYSTEM (DECK)



	Description: NOFIRNO sleeve type multi-cable transit system for A-60 class deck transits			
	Mat.: NOFIRNO rubber & sealant		Scale: 1 : 2	
Ref.: JAB	Date:	22-04-17		
No part of this document may be reproduced by photocopy, print, microfilm or any means without the written permission of BEELE Engineering by of The Netherlands	Rev. 1		NFN 053E	
	Rev. 2			

INSTALLATION INSTRUCTIONS FOR NOFIRNO® MULTI-CABLE TRANSIT SEALING SYSTEM



Flanged frames with a flange for bolting (60 mm wide and 6 mm thick) with a hole configuration for fixation, can be used also for the NOFIRNO® multi-cable sealing system.

INSTALLATION INSTRUCTIONS FOR NOFIRNO® MULTI-CABLE TRANSIT SEALING SYSTEM

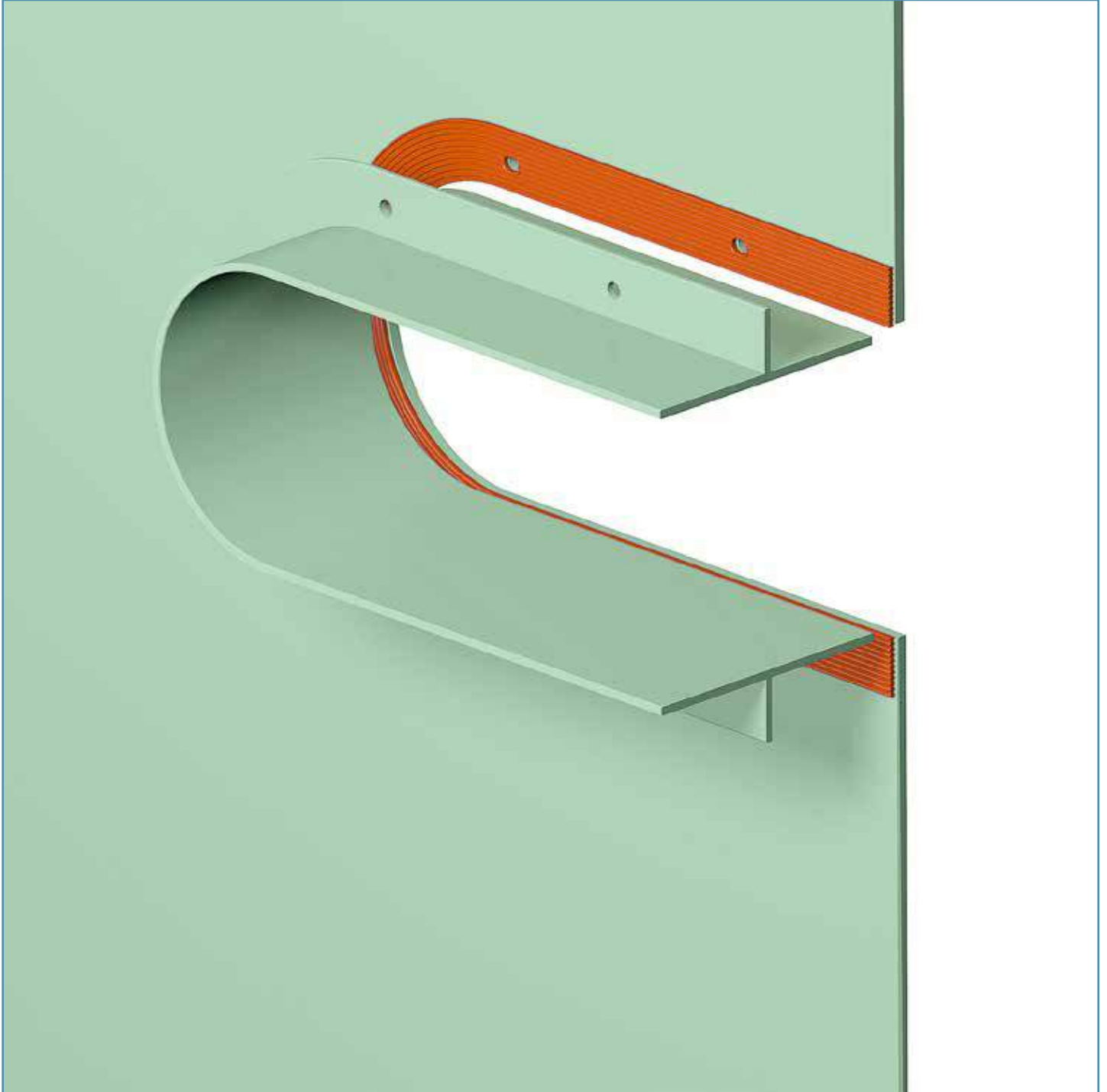

The flanged transit frames are bolted against the partition. A fire safe NOFIRNO® gasket has to be applied between the flange of the transit frame and the partition. The gaskets have a designed profiling to exclude the need for excessive compression (6-10 Nm is sufficient). The reduced forces on the profiled rubber make the usual need for retightening from time to time a thing of the past.

INSTALLATION INSTRUCTIONS FOR NOFIRNO® MULTI-CABLE TRANSIT SEALING SYSTEM

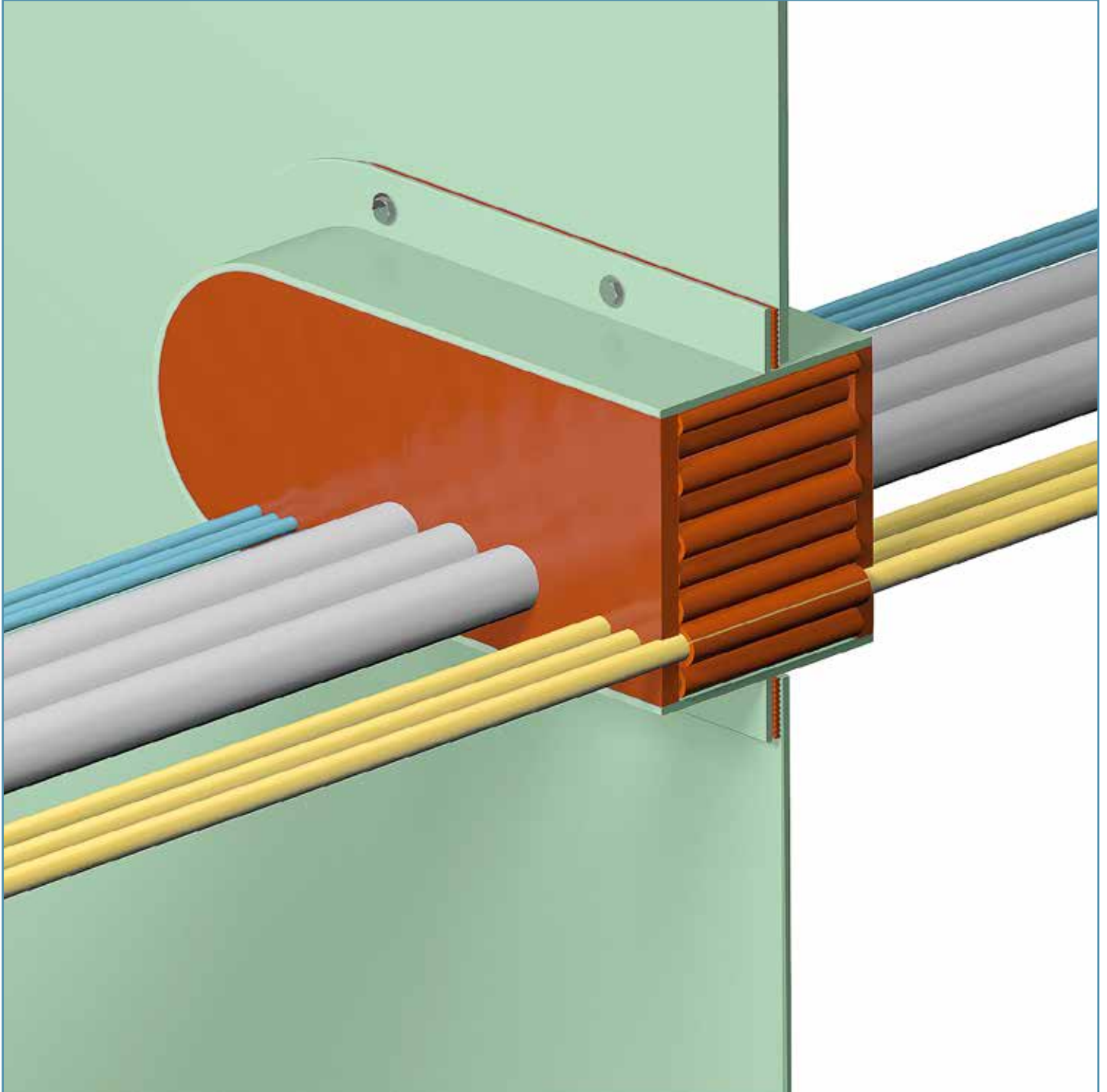

For A-class penetrations (which are insulated), the NOFIRNO® multi-cable transit frame needs to be insulated only at the insulated side of the bulkhead or at the lower side of the deck. No extra insulation needed in front of the penetration and/or in between the cables. Tested with larger amounts LAN data cables (bundled as well), up to CLX high voltage cables with conductors up to 3 x 380 mm² with an OD of 105 mm.

Note: for the larger cable sizes, NOFIRNO® cable wraps have to be used.

INSTALLATION INSTRUCTIONS FOR NOFIRNO® MULTI-CABLE TRANSIT SEALING SYSTEM

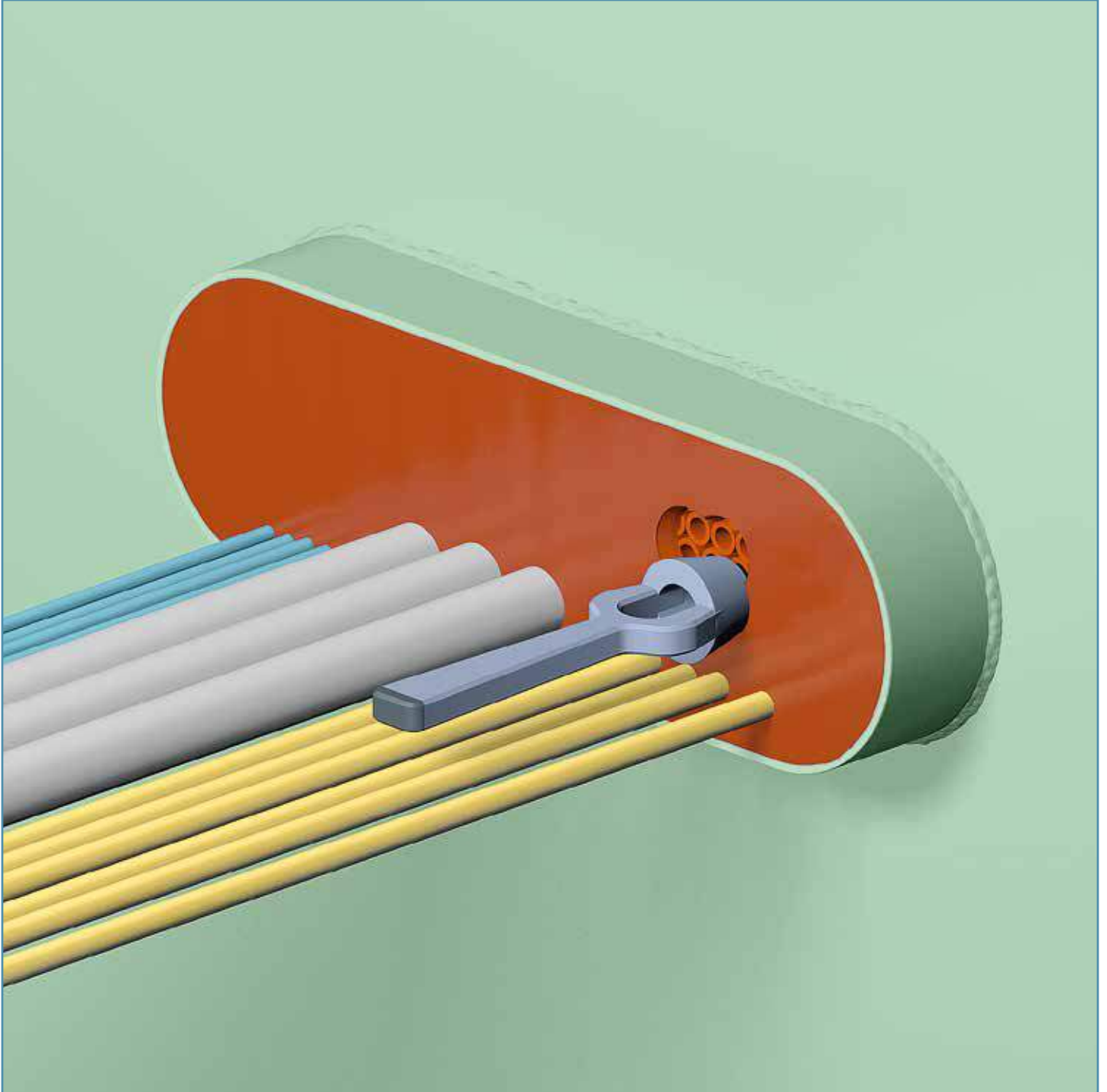

Adding extra cables through a finished NOFIRNO® multi-cable transit is an easy job. With the use of NOFIRNO® filler and cable sleeves as separators, no permanent deformation of the rubber parts will occur, and the cables are ducted individually. This means there is no need to disassemble the whole transit. Cut away the sealant layer at both sides of the penetration with a plastic knife or a hollow punch in a tapering shape, at a spot where there is sufficient spare space visible on the surface of the sealant layer.

INSTALLATION INSTRUCTIONS FOR NOFIRNO® MULTI-CABLE TRANSIT SEALING SYSTEM

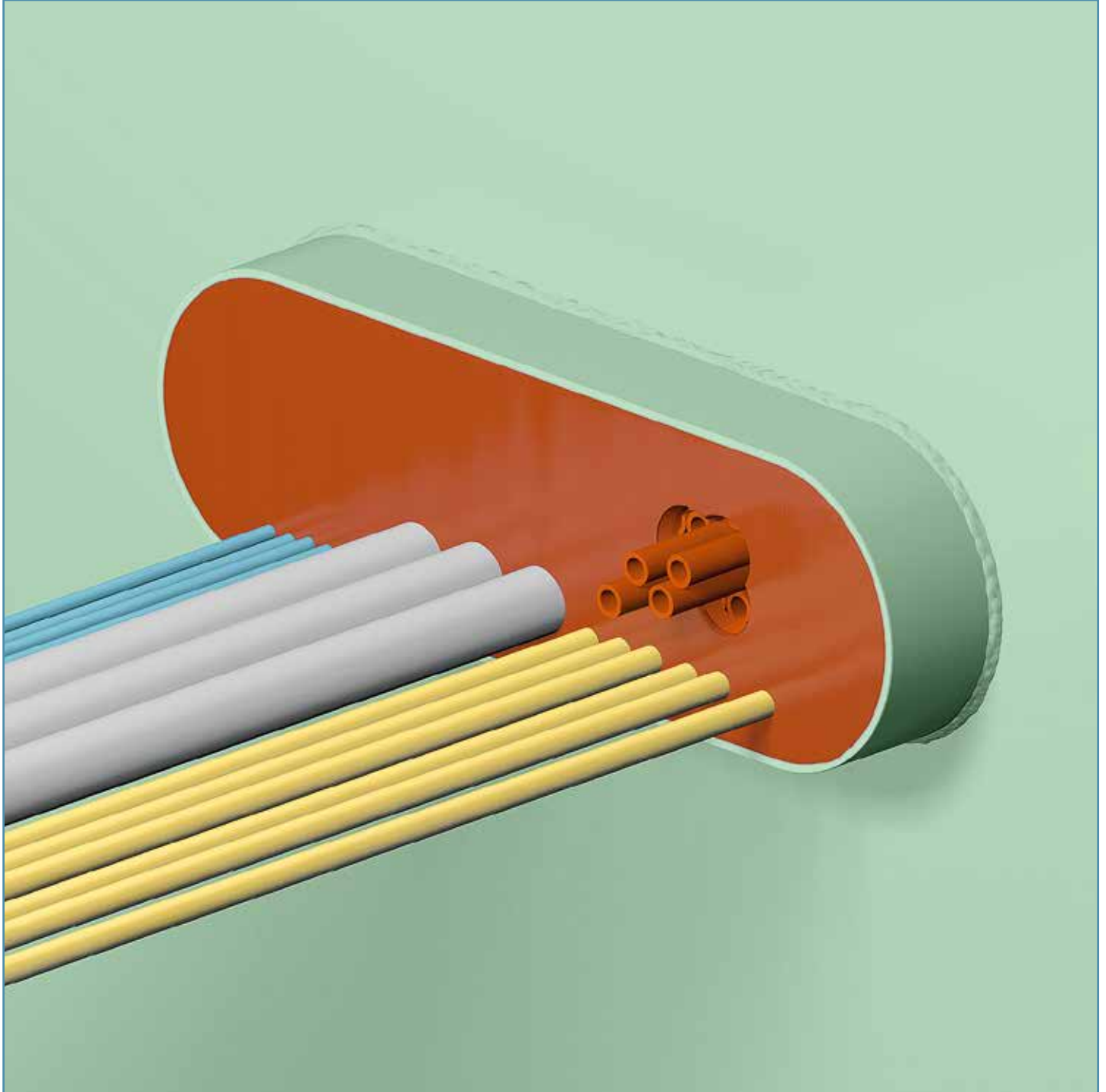

Remove one or more NOFIRNO® filler sleeves to create a fitting opening for the cable to be ducted.

INSTALLATION INSTRUCTIONS FOR NOFIRNO® MULTI-CABLE TRANSIT SEALING SYSTEM

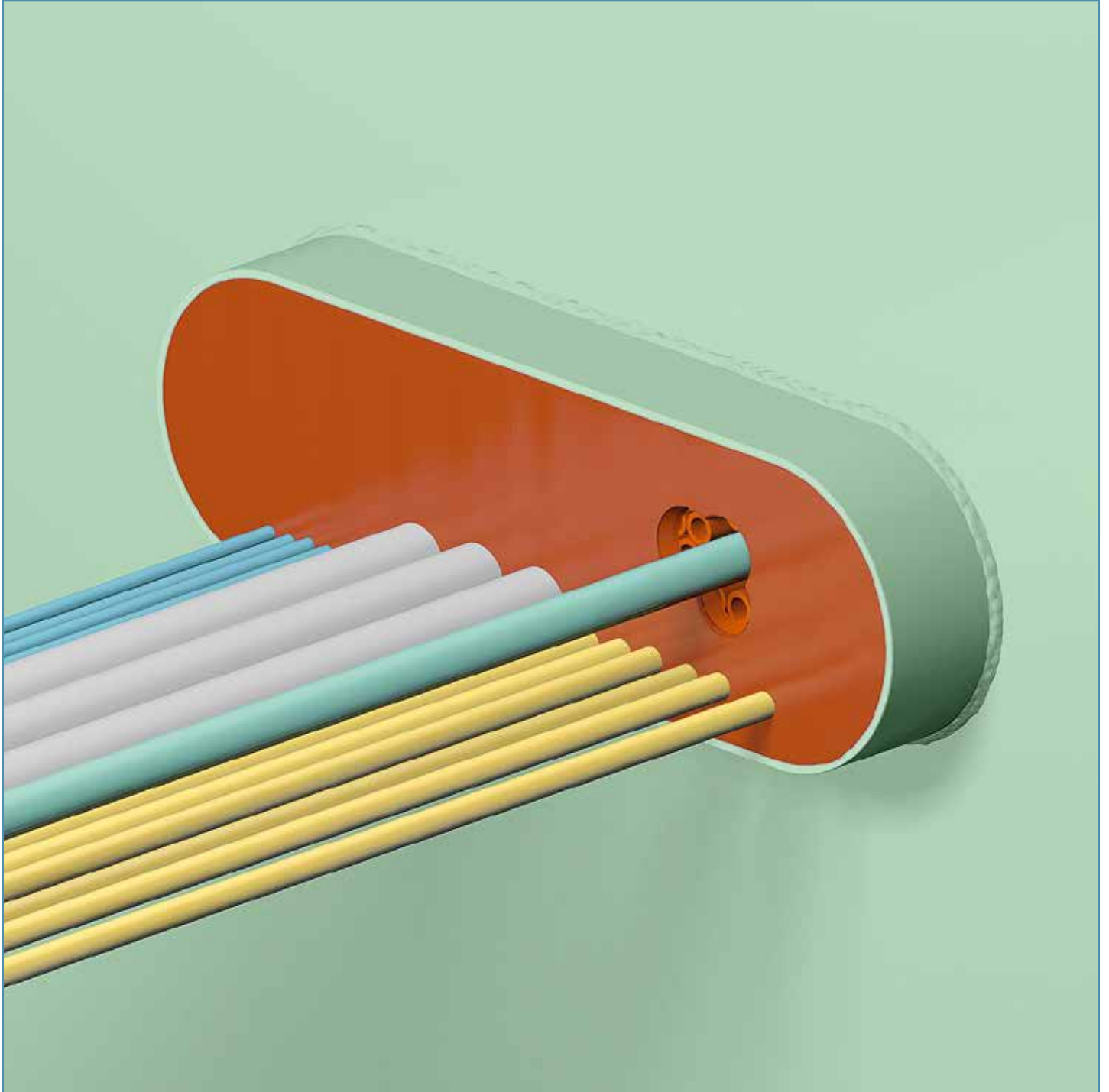

A cable is pulled through the free passage opening in the NOFIRNO® multi-cable transit. For adding cables, there is in fact no more disassembling needed than removing some filler sleeves. No extra costs for the extension of the cable set other than some new sealant to be applied.

INSTALLATION INSTRUCTIONS FOR NOFIRNO® MULTI-CABLE TRANSIT SEALING SYSTEM

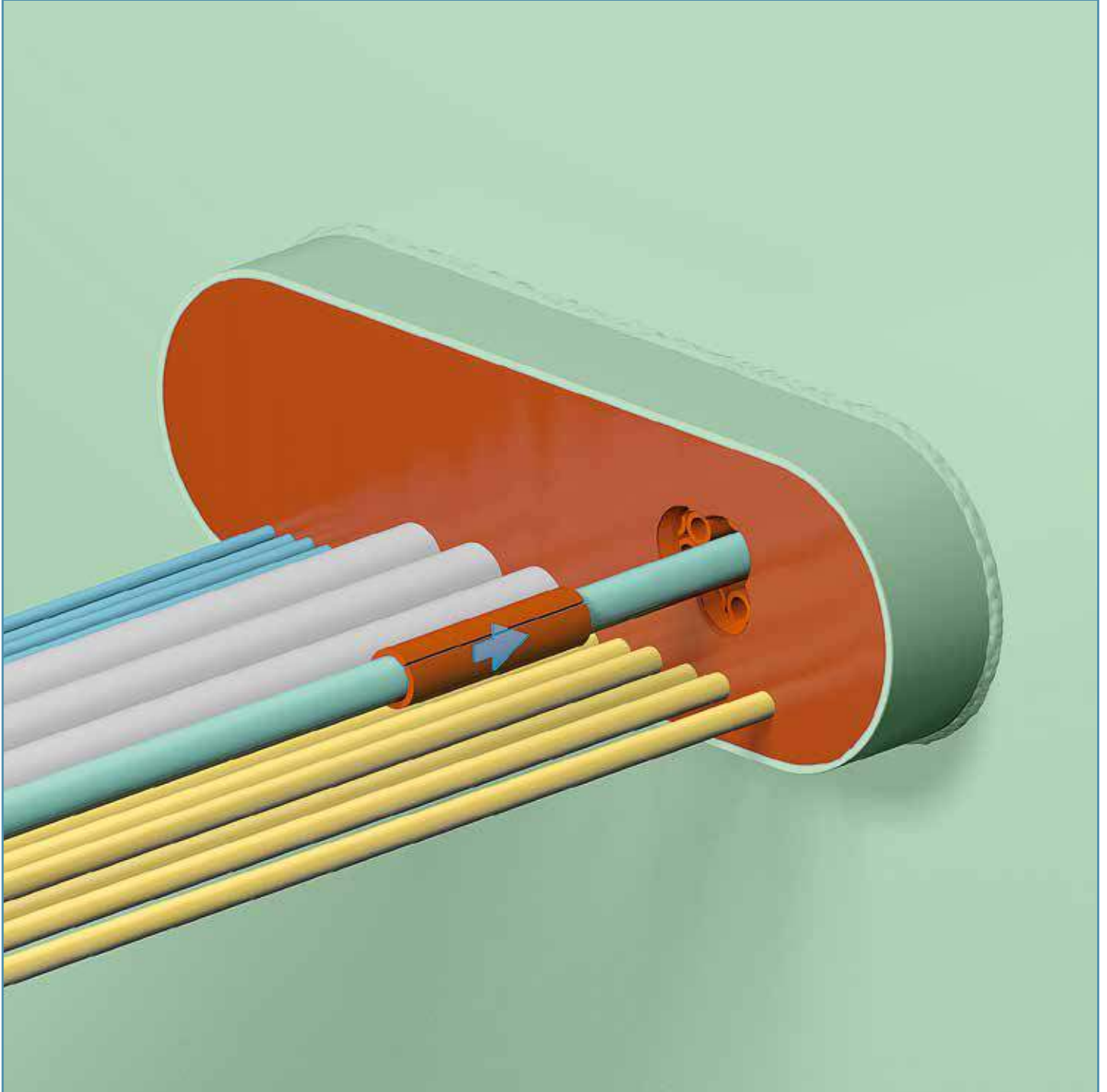

Place a NOFIRNO® sleeve around the newly ducted cable. Push the insert sleeve into the conduit so that it is even with the other sleeves.

INSTALLATION INSTRUCTIONS FOR NOFIRNO® MULTI-CABLE TRANSIT SEALING SYSTEM

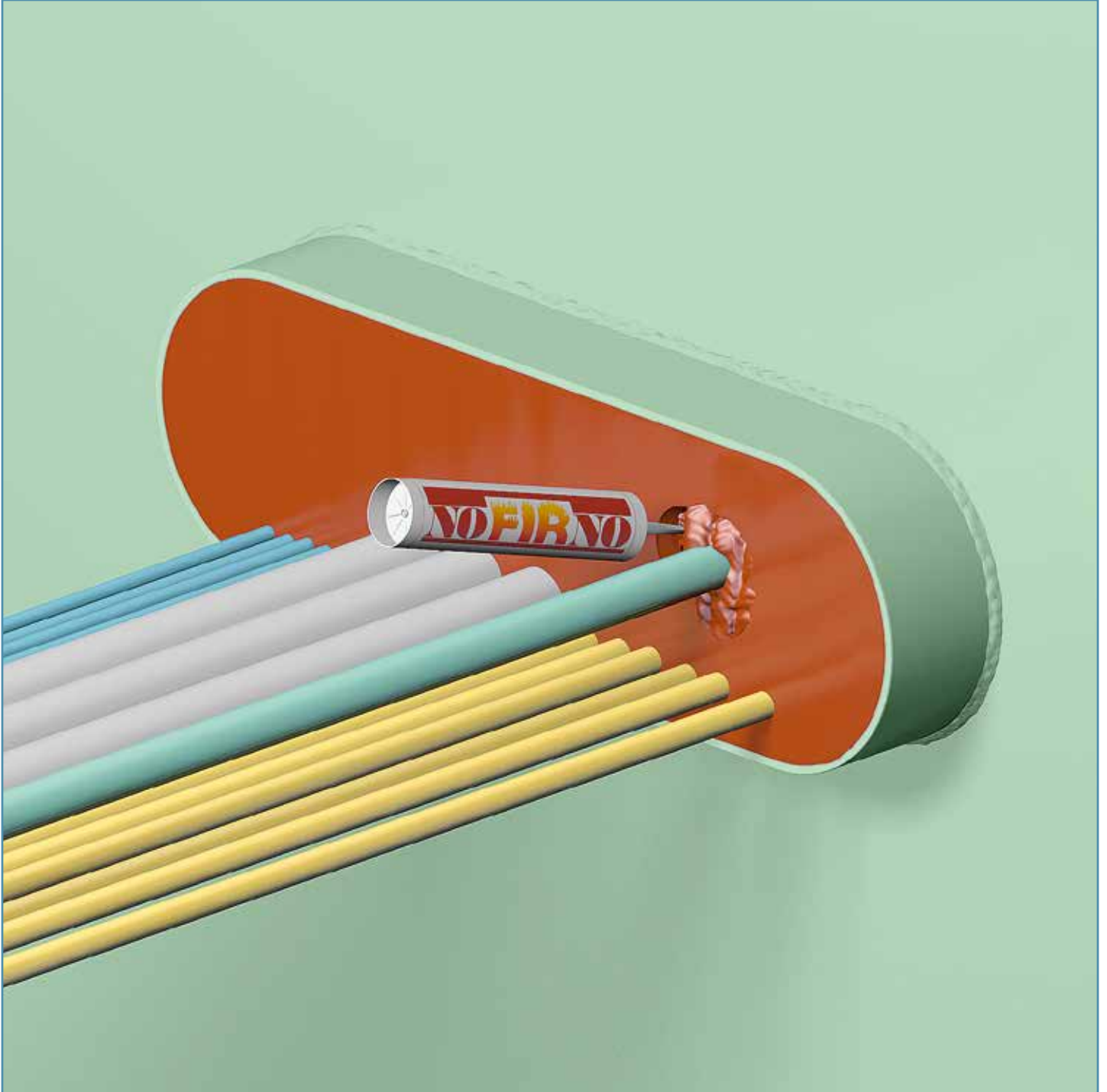

Clean and dry the newly ducted cable thoroughly and refill the opening in the sealant layer at both sides of the transit with NOFIRNO® sealant.

The fresh sealant adheres very well to the already cured sealant. Finish the new sealant layer in the same way as done for the initial sealant layer.

Please refer to the Safety Data Sheet for more information about the working environment.

INSTALLATION INSTRUCTIONS FOR NOFIRNO® MULTI-CABLE TRANSIT SEALING SYSTEM

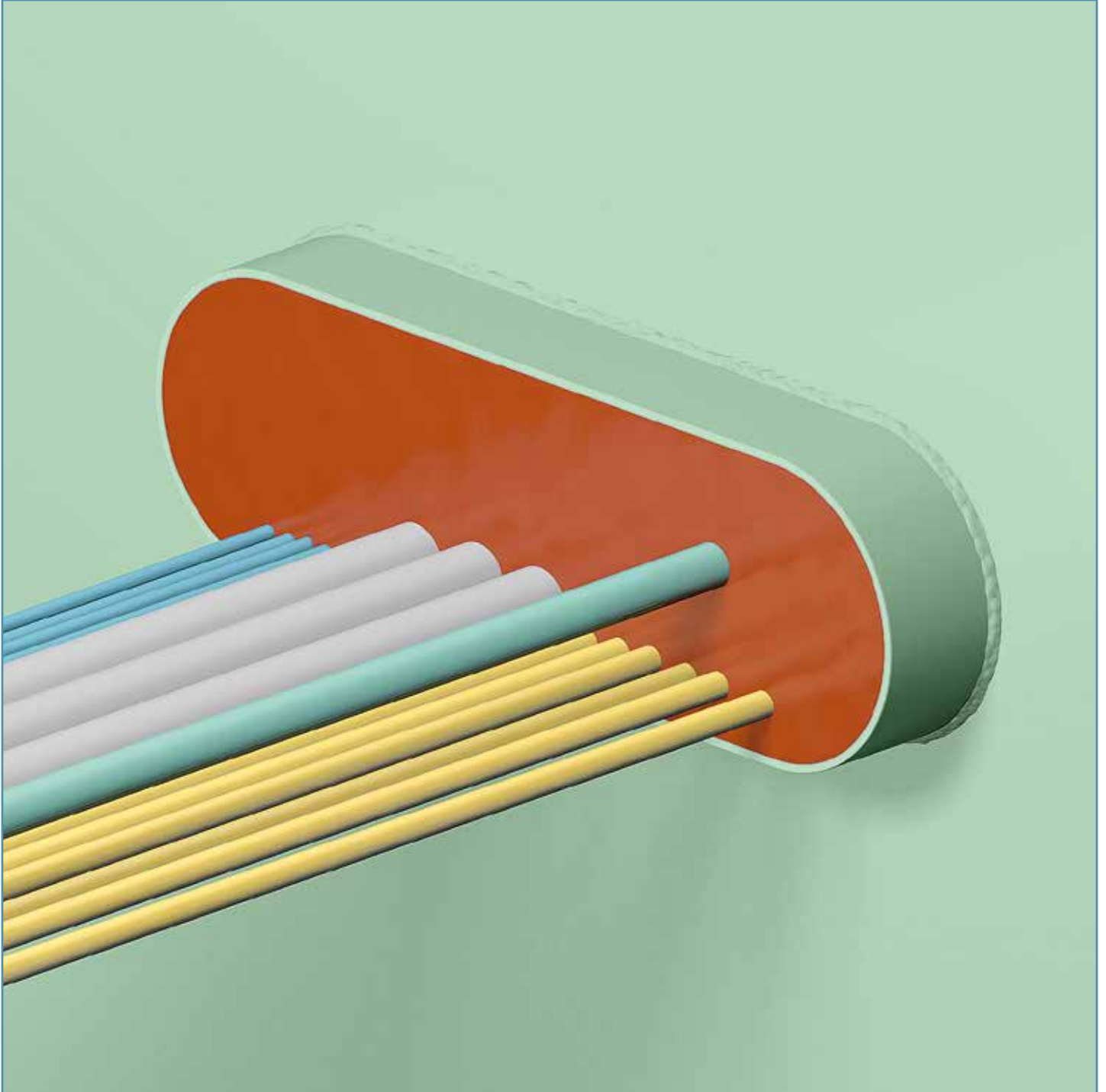

Note: time needed for curing of the sealant is dependent on air humidity in combination with the environmental temperature.

INSTALLATION INSTRUCTIONS FOR NOFIRNO® BLIND TRANSIT SEALING SYSTEM

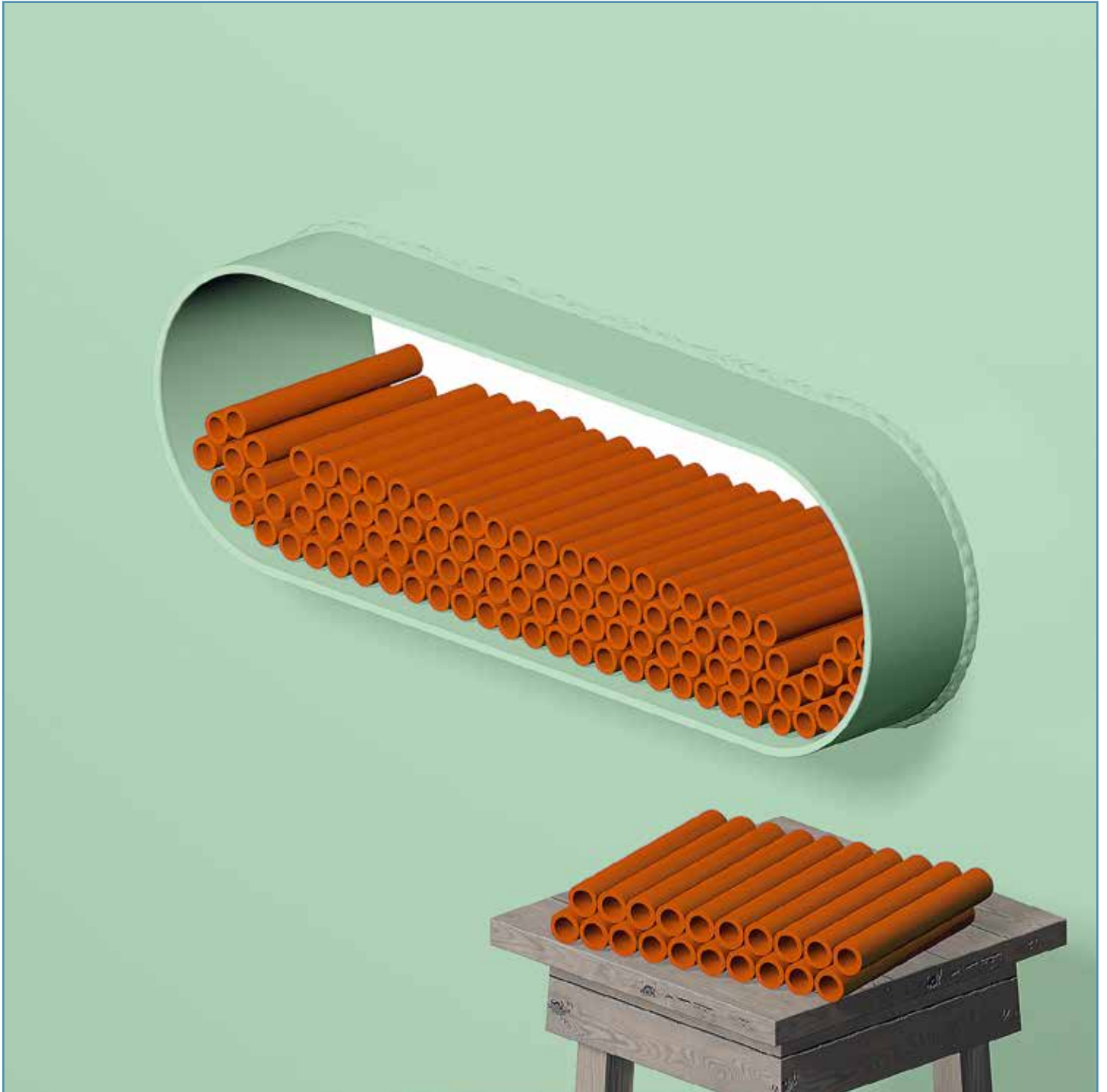

The space inside the transit frame is filled with NOFIRNO® filler sleeves type 22/15. For ease of filling, the NOFIRNO® filler sleeves are supplied non-split. Multi-filler sleeves (set of 10) are preferred for filling larger spaces.

Filling the conduit frame with NOFIRNO® multi-filler sleeves starts with stacking the multi-set on top of each other and to place rolled-up sets of multi-sleeves in the corners.

INSTALLATION INSTRUCTIONS FOR NOFIRNO® BLIND TRANSIT SEALING SYSTEM

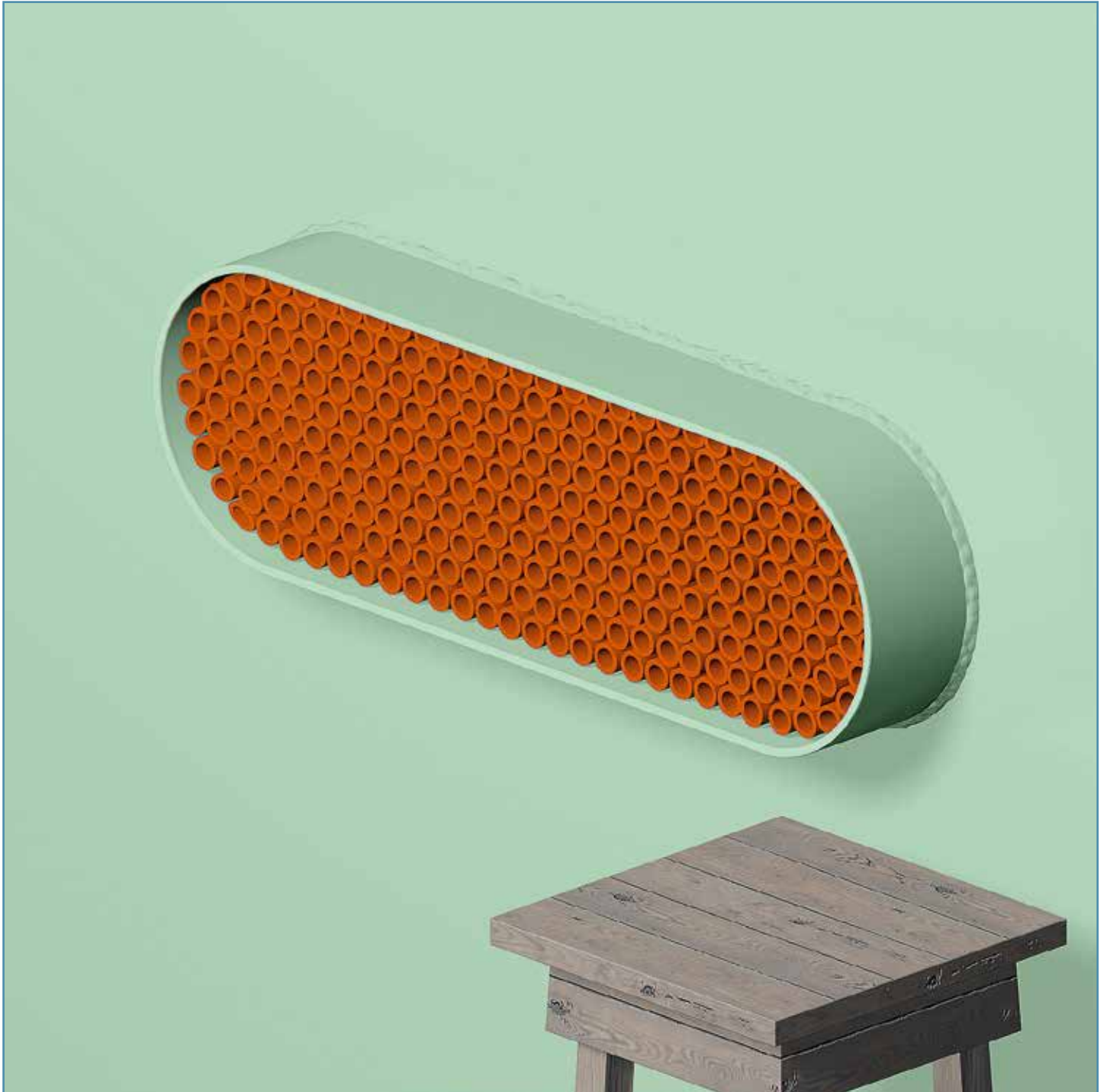

Before applying the NOFIRNO® sealant, it is advisable to perform a final check on the packing of the filler sleeves. A tight fit of the whole set of sleeves in the required ratio is not only vital for the mechanical stability of the sealing system, but also for the fire stopping properties. A final check should therefore be a part of quality control.

INSTALLATION INSTRUCTIONS FOR NOFIRNO® BLIND TRANSIT SEALING SYSTEM



The NOFIRNO rubber grade of the sleeves and the NOFIRNO® sealant, which are compounded under strict conditions in our factory, are suitable for gas and water tight ducting, and for fire rated applications as well. The NOFIRNO® sealant stays flexible at temperatures of -50 °C, allowing application in arctic environments.

The NOFIRNO® blind transits have excellent resistance to seawater, UV, ozone and weather. Based on the use of the high tech silicone composition of the NOFIRNO® sealant and rubber, the system offers excellent durability.

INSTALLATION INSTRUCTIONS FOR NOFIRNO® BLIND TRANSIT SEALING SYSTEM

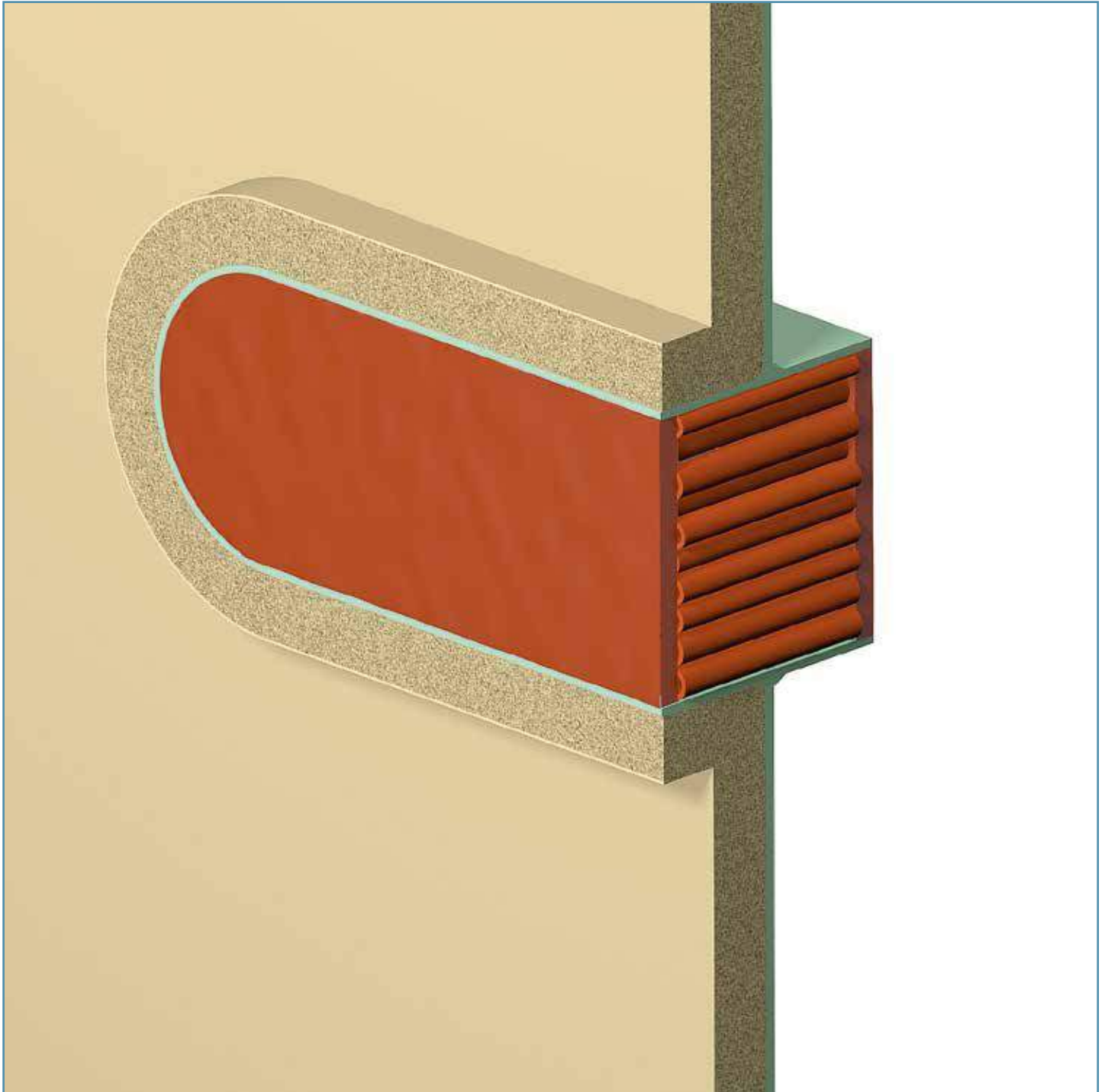

For A-class penetrations (which are insulated), the NOFIRNO® blind transit frame needs to be insulated only at the insulated side of the bulkhead or the lower side of the deck. No extra insulation needed in front of the transit. Also approved for deck penetrations.

For transits larger than 300x150 mm partitions have to be provided inside the coaming, dividing the transit in sections.

See drawings NFN 138E and NFN 139E.

INSTALLATION INSTRUCTIONS FOR NOFIRNO® BLIND TRANSIT SEALING SYSTEM

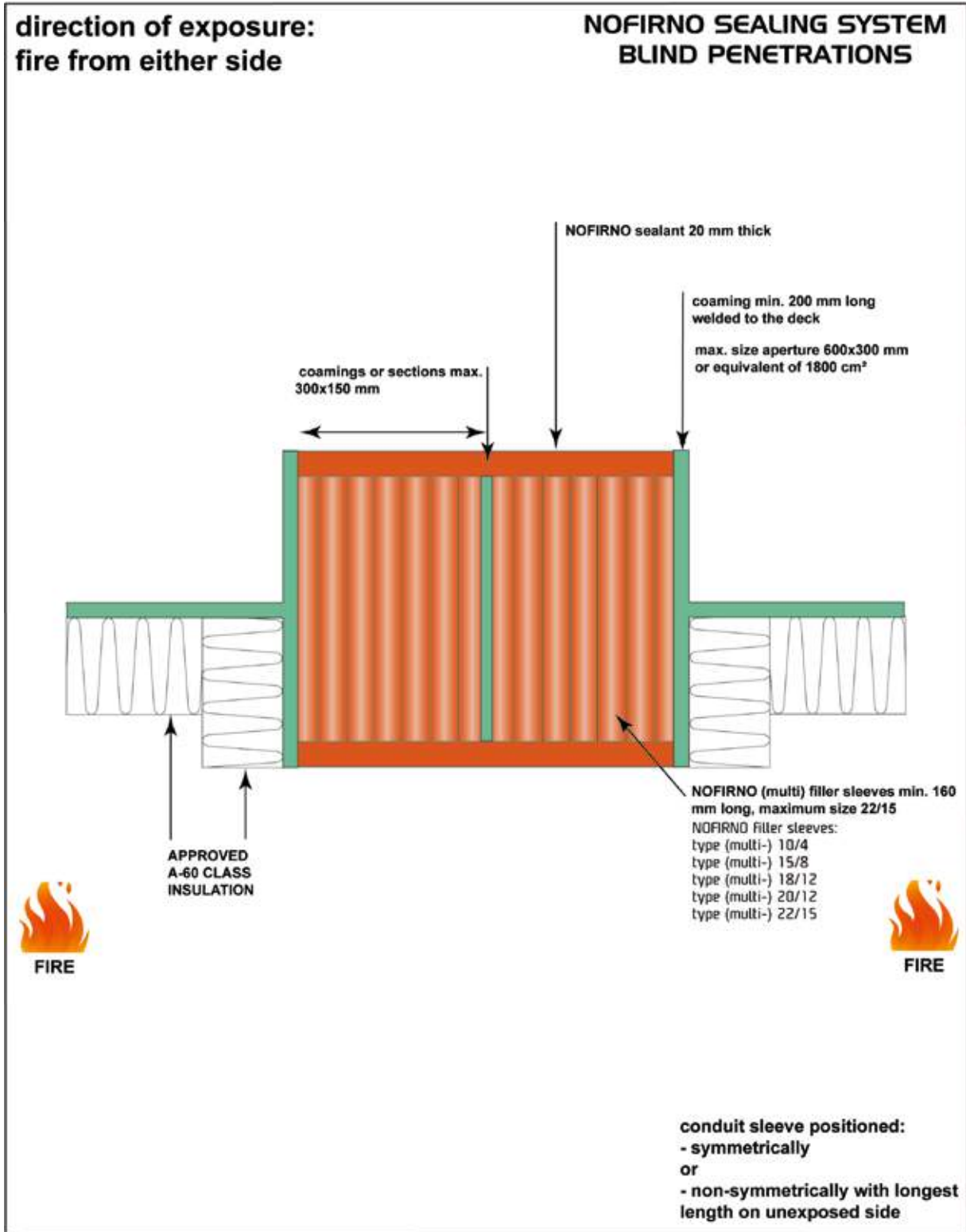

	Description: NOFIRNO sealing system for A60 class decks			
	Mat.: NOFIRNO sleeves/sealant			
Ref.: JAB	Date:	14-10-2019	Scale:	
<i>No part of this document may be reproduced by photocopy, print, microfilm or any means without the written permission of BEELE Engineering bv of The Netherlands</i>	Rev. 1		NFN 139E	
	Rev. 2			

INSTALLATION INSTRUCTIONS FOR NOFIRNO® MULTI-CABLE TRANSIT SEALING SYSTEM - MED CERTIFICATE

Page 1 / 3



Marine & Offshore

**BUREAU
VERITAS**

Notified Body 2690 - MARINE EQUIPMENT DIRECTIVE 2014/90/EU

Certificate number: 50891/B0 MED

File number: AC14000/041/013

Item number: MED/3.26a

USCG Module B number: 164.138 / EC2690

This certificate is not valid when presented without the full attached schedule composed of 7 sections

www.veristar.com

EC TYPE EXAMINATION CERTIFICATE

as per Module B of Directive 2014/90/EU of the European Parliament and of the Council of 23 July 2014 as transposed in the French Regulations and Commission Implementing Regulation (EU) 2018/773 of 15 May 2018

This certificate is issued to:

BEELE ENGINEERING

Aalten - NETHERLANDS

for the type of product

PENETRATIONS THROUGH "A" CLASS DIVISIONS : ELECTRIC CABLE TRANSITS
NOFIRNO Multi-cable transits

Requirements:

SOLAS 74 convention as amended, Regulations II-2/9

IMO Res MSC.307(88) -(2010 FTP Code)-

IMO MSC.1/Circ.1488

This certificate is issued on behalf of the French Maritime Authorities to attest that Bureau Veritas Marine & Offshore did undertake the relevant type-examination procedures for the product identified above which was found to comply with the relevant requirements of the Directive 2014/90/EU of the European Parliament and of the Council of 23 July 2014 as transposed in the French Regulations.

This certificate will expire on: 21 Jan 2024

For Bureau Veritas Marine & Offshore Notified Body 2690,

At BV GRONINGEN, on 21 Jan 2019,

John Mondt



This certificate does not allow to issue the Declaration of Conformity and to affix the mark of conformity (wheelmark ) to the products corresponding to this type. To this end, the production-control phase module (D, E or F) of Annex II of the Directive is to be complied with and controlled by a written inspection agreement with a notified body.

This certificate remains valid until the date stated above, unless cancelled or revoked, provided the conditions indicated in the subsequent page(s) are complied with and the product remains satisfactory in service. This certificate will not be valid if the applicant makes any changes or modifications to the approved product, which have not been notified to, and agreed in writing with Bureau Veritas Marine & Offshore. Should the specified regulations or standards be amended during the validity of this certificate, the product(s) is/are to be re-approved prior to it/they being placed on board vessels to which the amended regulations or standards apply. Bureau Veritas Marine & Offshore is designated by the French Maritime Authority as a "notified body" under the terms of the French Regulations Division 140 Chapter 140-2. This certificate is issued within the scope of the General Conditions of Bureau Veritas Marine & Offshore available on the internet site www.veristar.com. Any Person not a party to the contract pursuant to which this document is delivered may not assert a claim against Bureau Veritas Marine & Offshore for any liability arising out of errors or omissions which may be contained in said document, or for errors of judgement, fault or negligence committed by personnel of the Society or of its Agents in establishment or issuance of this document, and in connection with any activities for which it may provide.

The electronic version is available at: <http://www.veristamb.com/veristamb/jsp/viewPublicPdfTypepec.jsp?id=beDivfgma>

STATE-OF-THE ART MULTI-CABLE TRANSIT SEALING SYSTEMS

The logo for RISE, featuring the word "RISE" in a stylized, bold, red font with a white outline and a slight 3D effect.The logo for RISE, featuring the word "RISE" in a stylized, bold, red font with a white outline and a slight 3D effect.The logo for CONDUCTON, featuring the word "CONDUCTON" in a red, outlined font with a double-line border.The logo for NOFIRNO, featuring the word "NOFIRNO" in a bold, orange font with a white outline, set against a background of stylized flames.The logo for CONTROFIL, featuring the word "CONTROFIL" in a bold, blue font with a white outline, and "MULTI-CABLE TRANSITS" in a smaller, white font below it, all on a dark blue background.The logo for CET-A-SIL, featuring the word "CET-A-SIL" in a bold, blue font with a white outline.

RISE®

- For fire, gas, smoke and watertight sealing of multi-cable penetrations.
- Compact system. No precise fitting parts.
- No metal parts, no corrosion.
- Most cost-effective way of installation.
- No pre-engineering or special conduit frames.
- No restrictions on cable types and sizes, no insulation in front of the penetration needed.
- Adding or removing cables an easy matter.
- RISE® EXTEND-A-FRAME for upgrading block systems - doubles the usable space!
- RISE® CONDUCTON® for EMC penetrations - high attenuation values - no galvanic corrosion - no aging.
- **Proven - for new and upgraded installations.**
- The system of choice in shipyards worldwide for more than 25 years!

NOFIRNO®

- System technology based on RISE®.
- Even easier installation.
- Even higher pressure ratings.
- Jet Fire tested for harshest applications.
- Bundled cable sets approved
- **Breakthrough - A-class with 15 mm both sides.**
- The system of choice for highest fire ratings and harshest environment!

CONTROFIL®

- Newest technology for cable ducting and sealing.
- Newest rubber technology - CRUSHNOF® rubber.
- Shorter conduit depths - flexible composition.
- Prevents overfilling of cable transits.
- Fire tight - watertight.
- **Breakthrough - controlled filling of transits.**
- The system of choice for neat cable routing in installations.

CET-A-SIL®

- Multi-gland system for electrical cabinets.
- Modular system - sealing plugs and modules.
- Suitable for IP 68 rated equipment.
- Watertight up to 4 meter water column.
- No compression on cable sheathings.
- No metal parts - no corrosion - no O-rings.
- **Breakthrough - no disassembling to add cables.**
- The alternative system for cable glands.

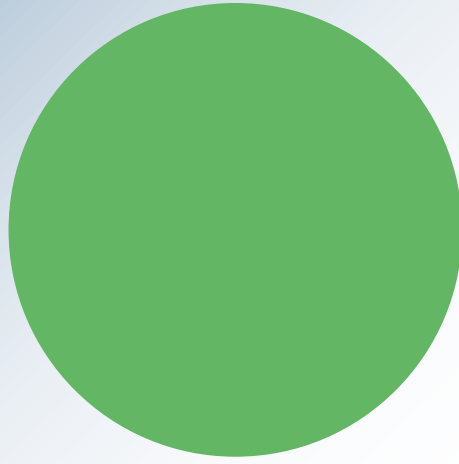

WE CARE

**BEELE ENGINEERING:
A COMPANY DEDICATED
TO SAFETY
FOR OVER 45 YEARS**



**THORNE &
DERRICK
INTERNATIONAL**

Thorne & Derrick
+44 (0) 191 410 4292
www.powerandcables.com